

LEFT1
SCALE 1:8

96 $\frac{7}{8}$

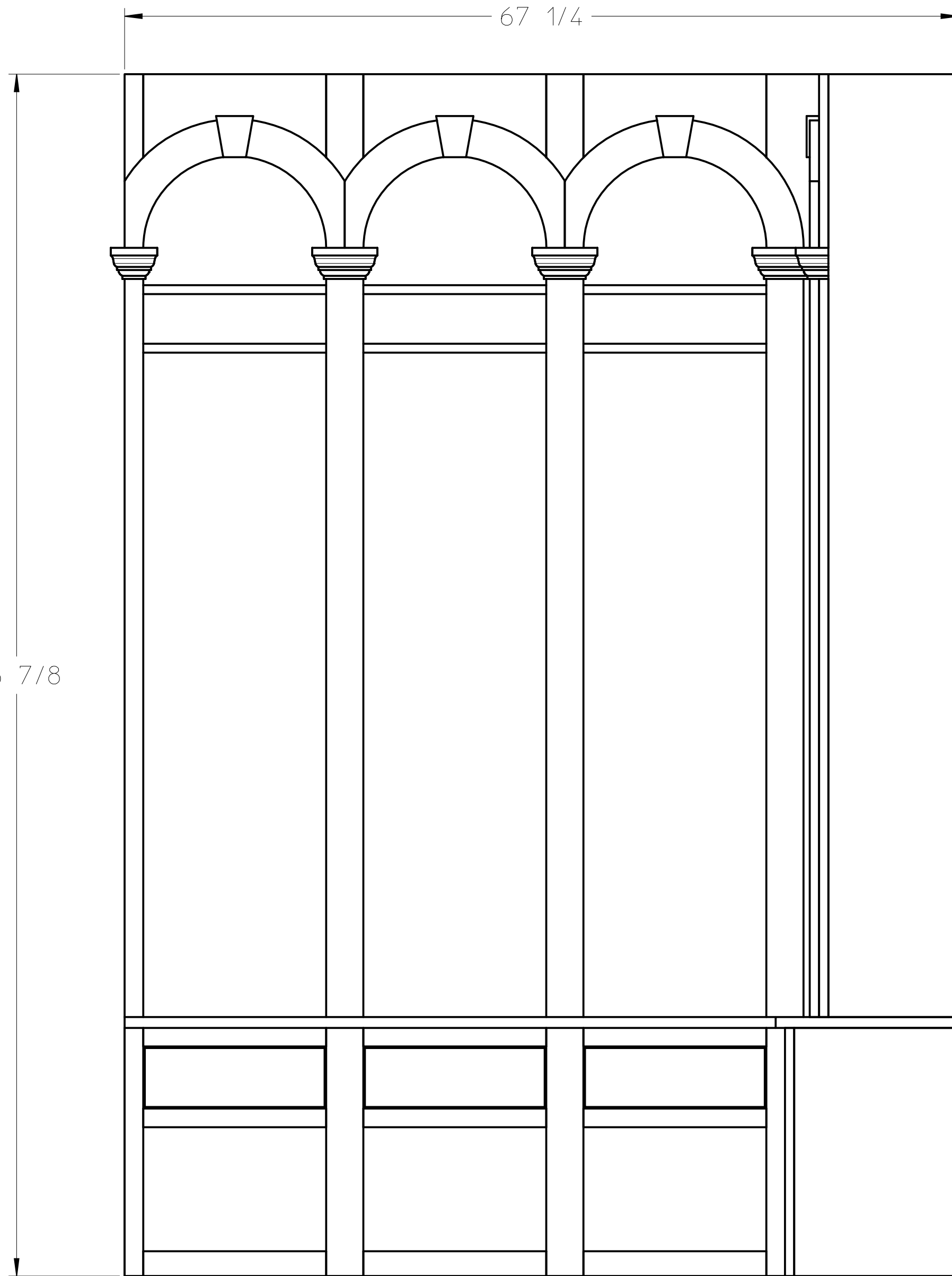

FRONT1
SCALE 1:8

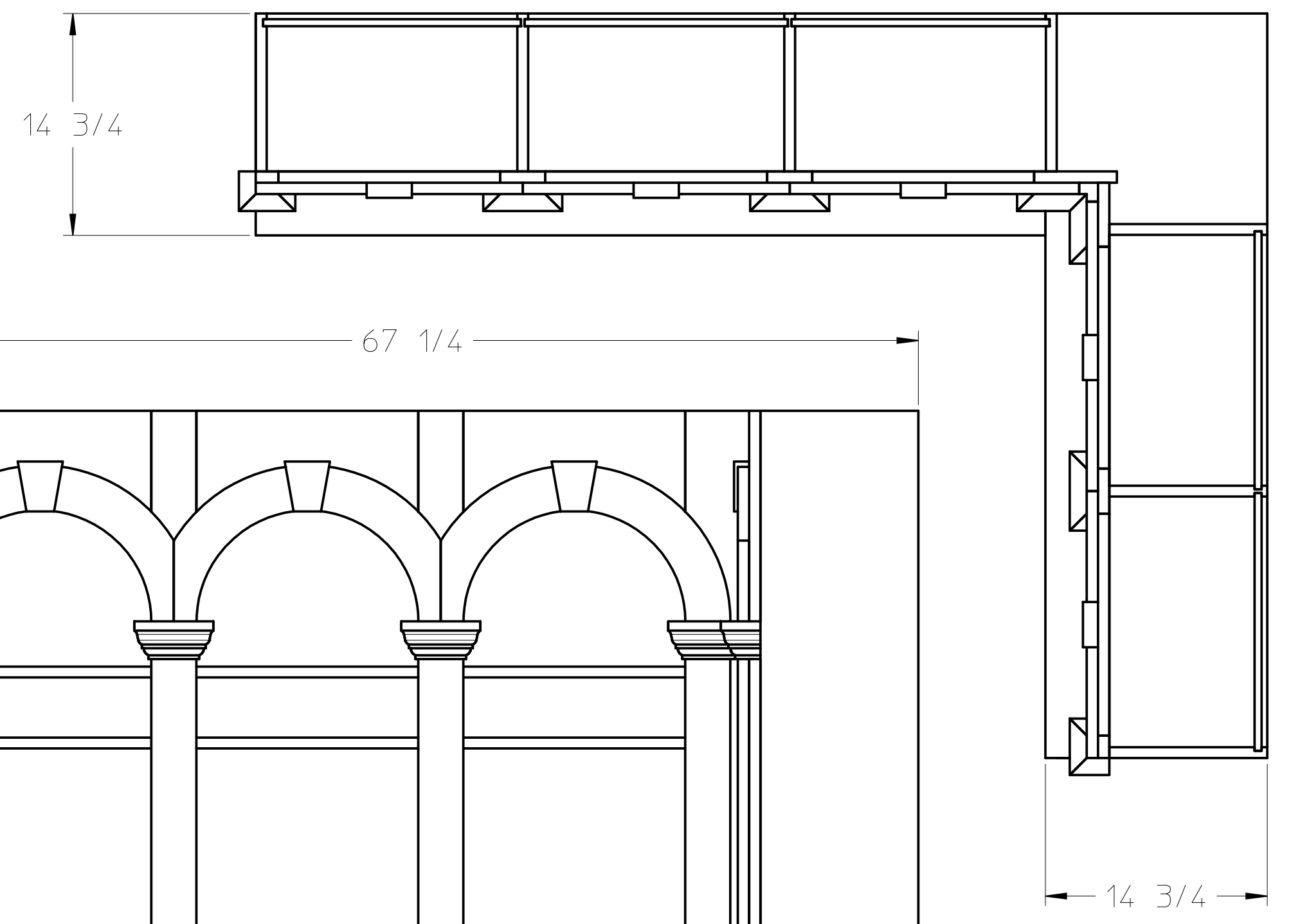

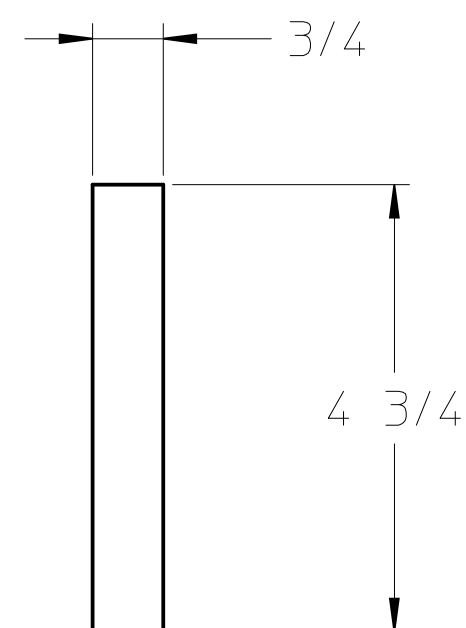
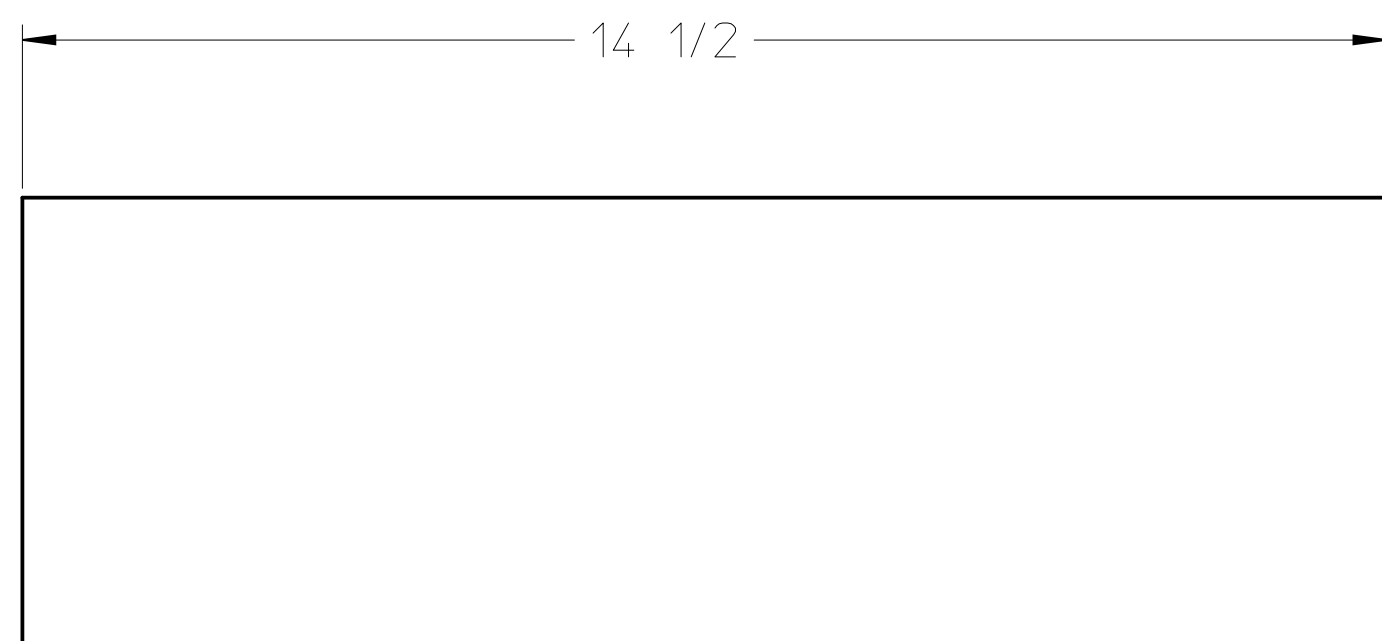
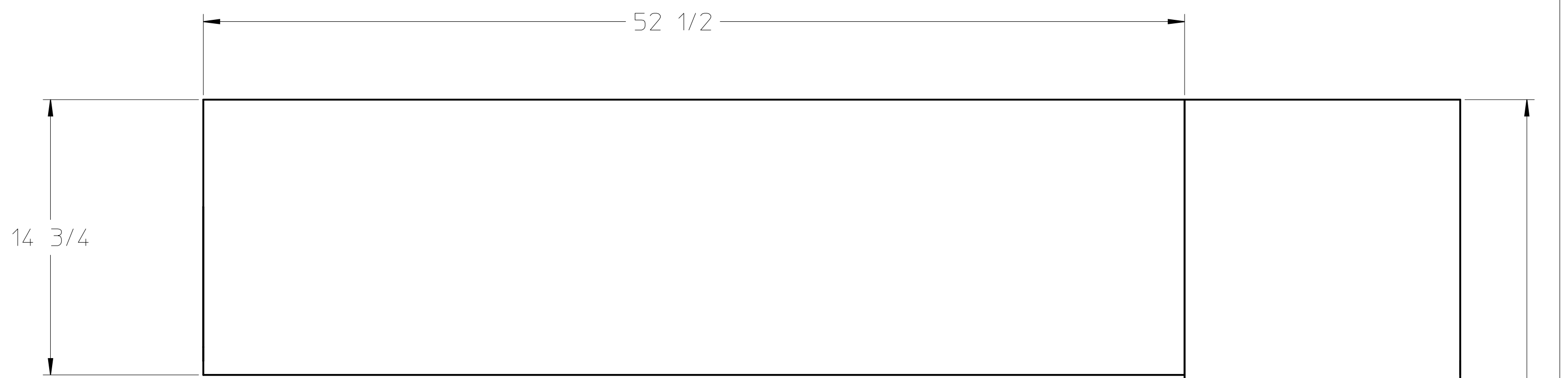

Drawer Fronts (Qty 5)

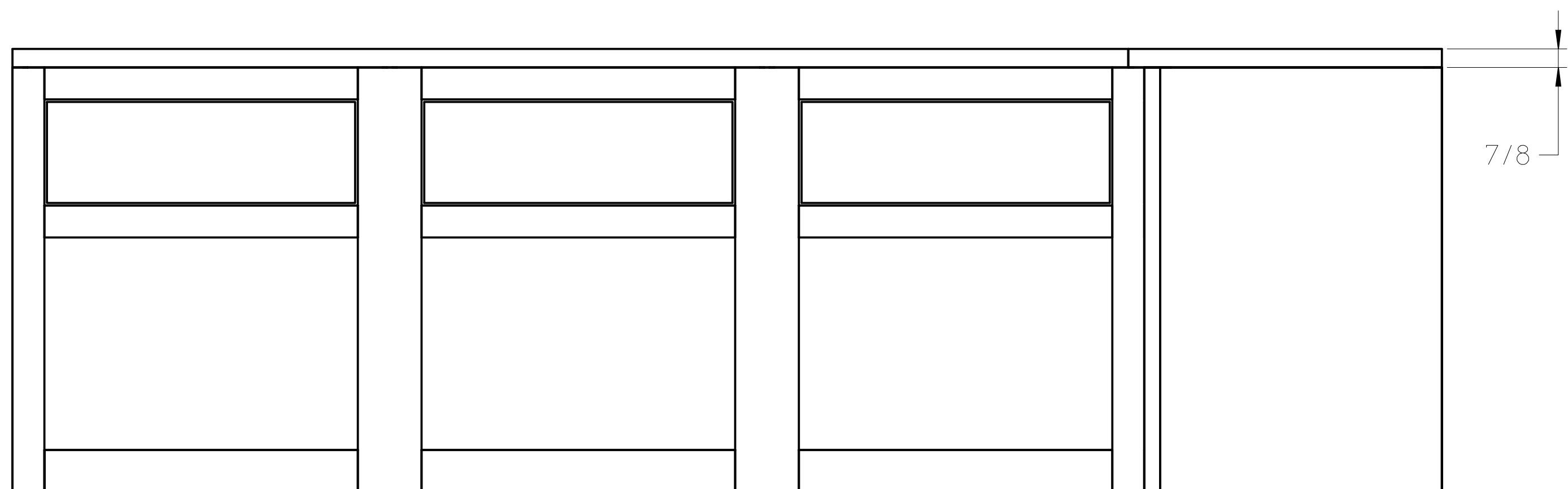
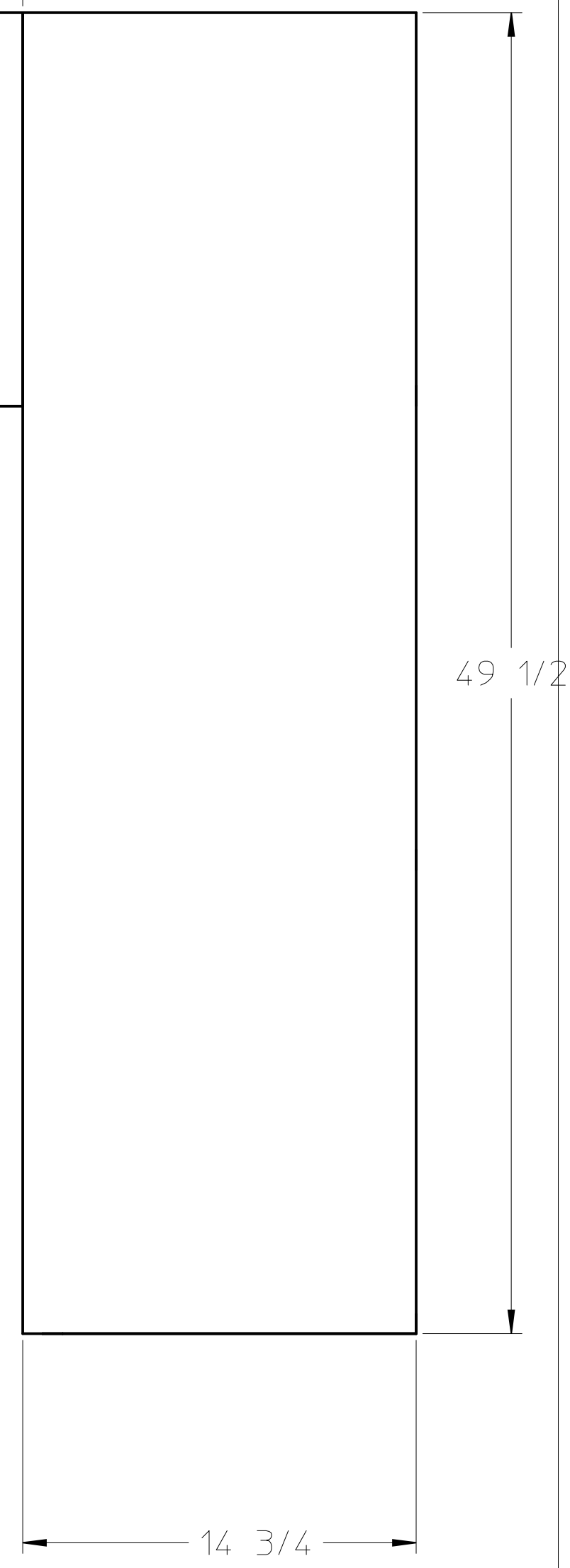

BENCH AND DRAWER FRONTS

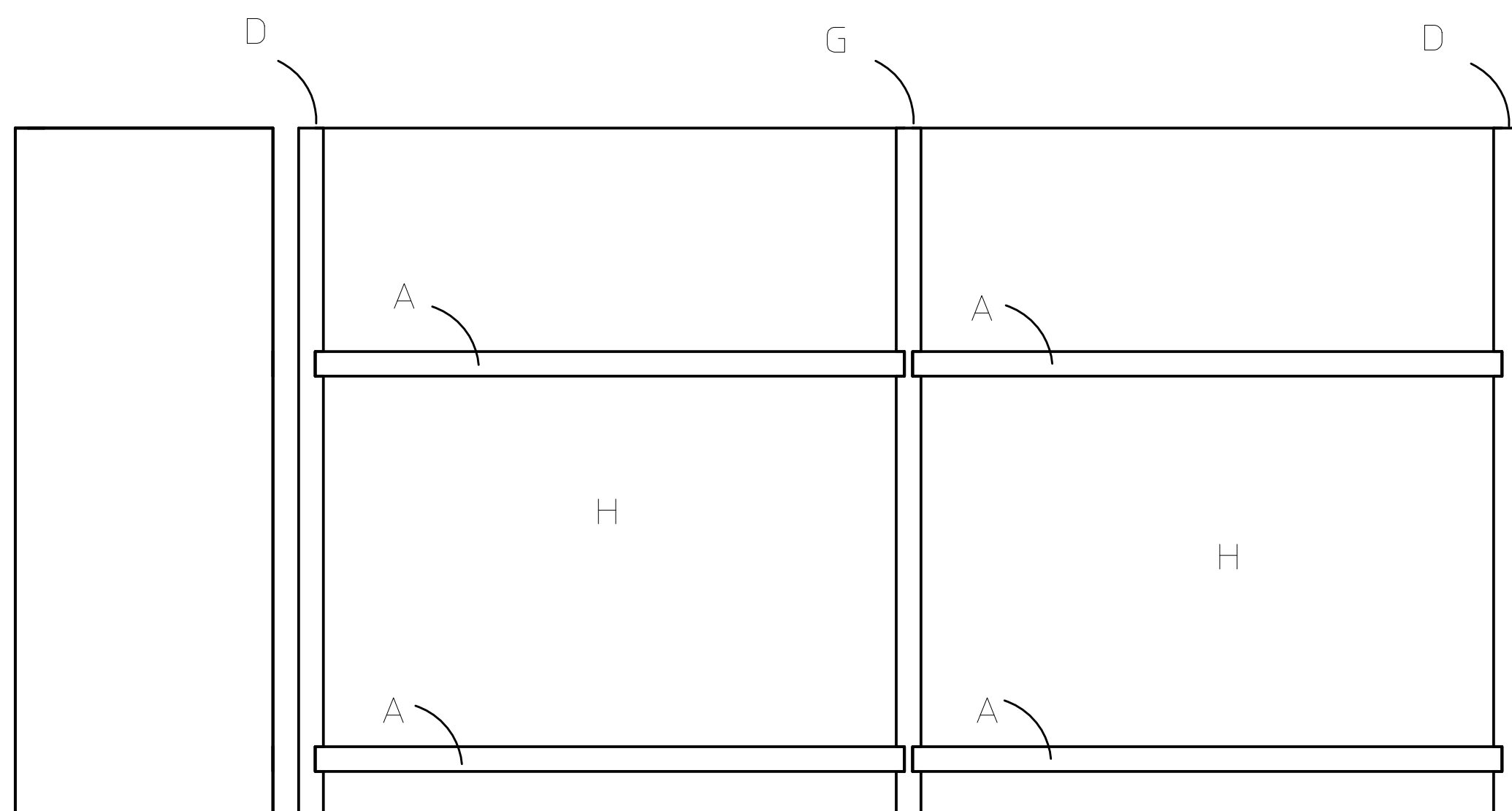
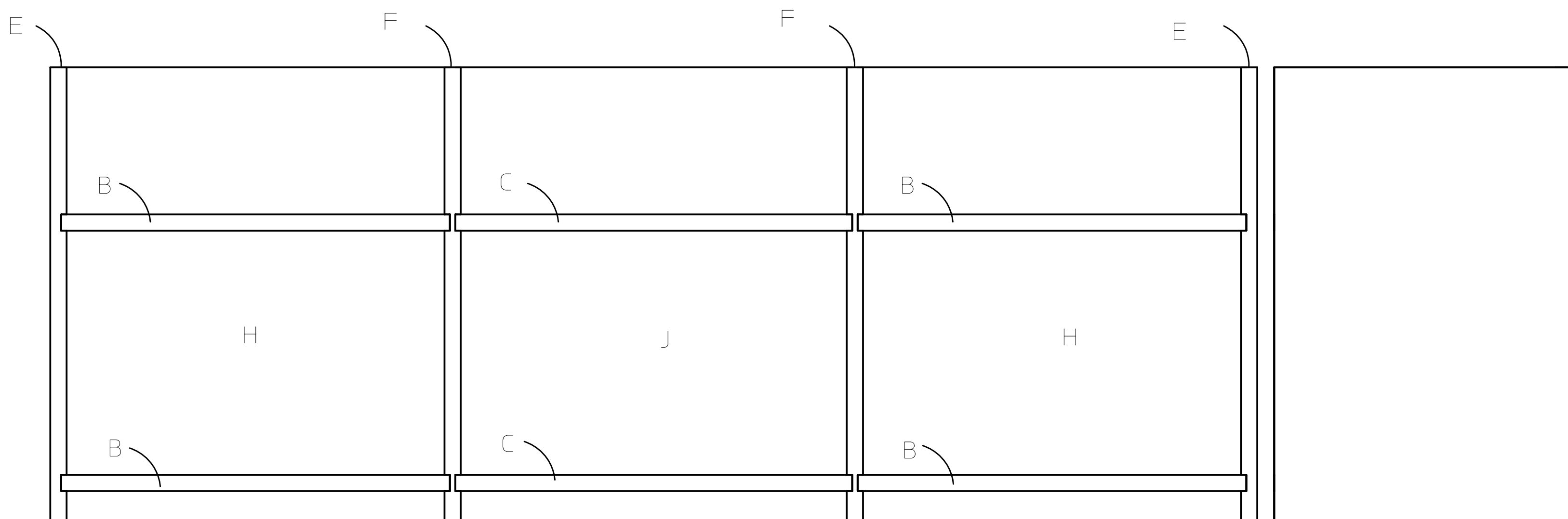

BOM: Bench Carcass

Pos	Qty	Part Name	Dimension	Material
A	4	Shelves	17 5/32 x 12 13/32	3/4 PLY
B	4	Shelves_Narrow	17 5/32 x 6 21/32	3/4 PLY
C	2	Shelves_Narrow_Middle	17 33/64 x 6 21/32	3/4 PLY
D	2	Sides	20 x 13 1/4	3/4 PLY
E	2	Sides_Narrow	20 x 7 1/8	3/4 PLY
F	2	Vertical_Divider_Narrow	20 x 7 1/8	3/4 PLY
G	1	Vertical_Divider	20 x 13 1/4	3/4 PLY
H	4	Backs	20 x 17 5/32	1/2 PLY
J	1	Backs_Middle	20 x 17 33/64	1/2 PLY

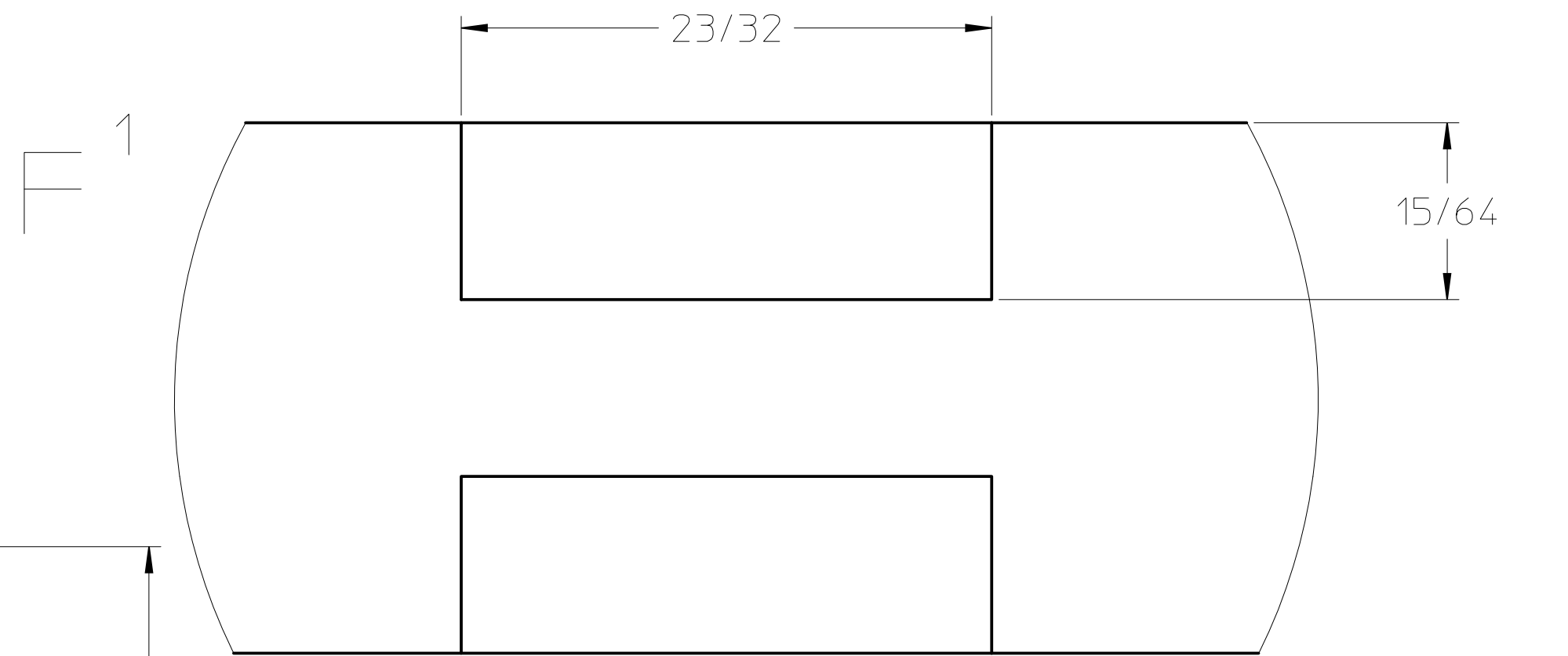
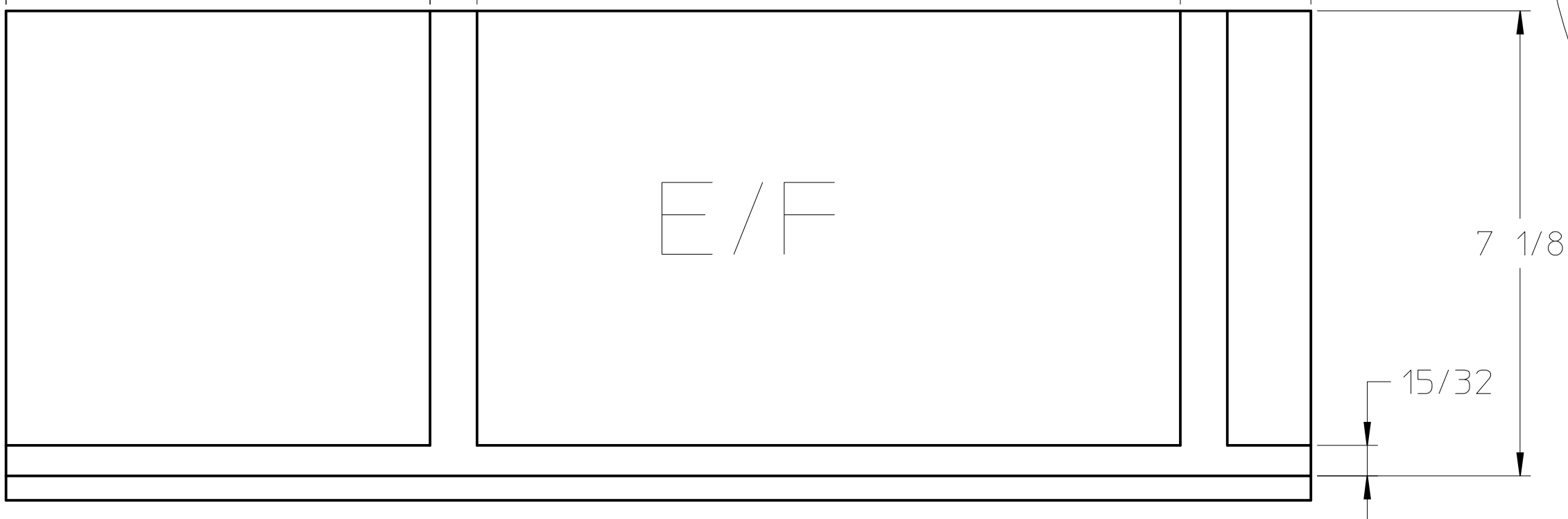
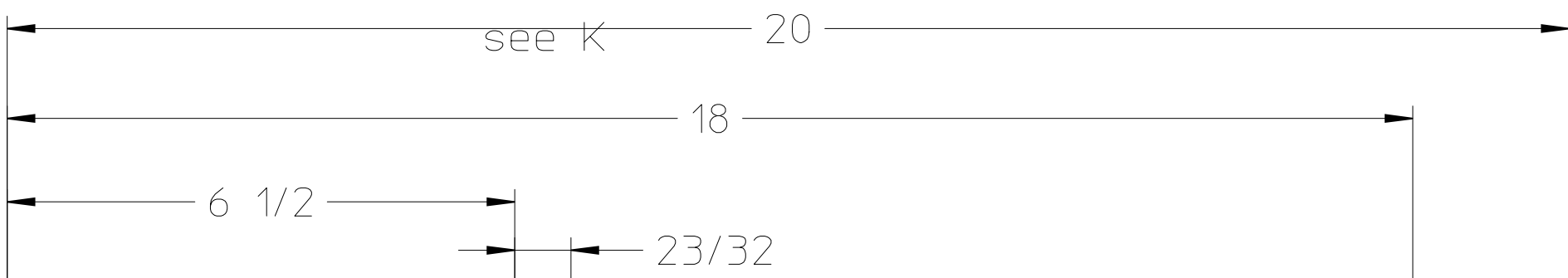
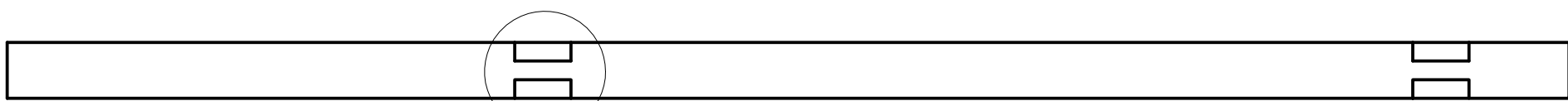
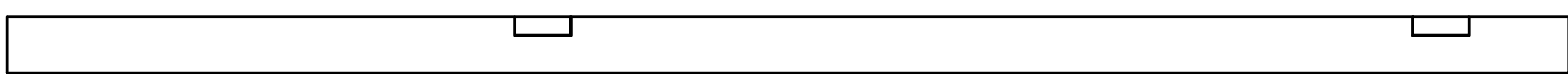
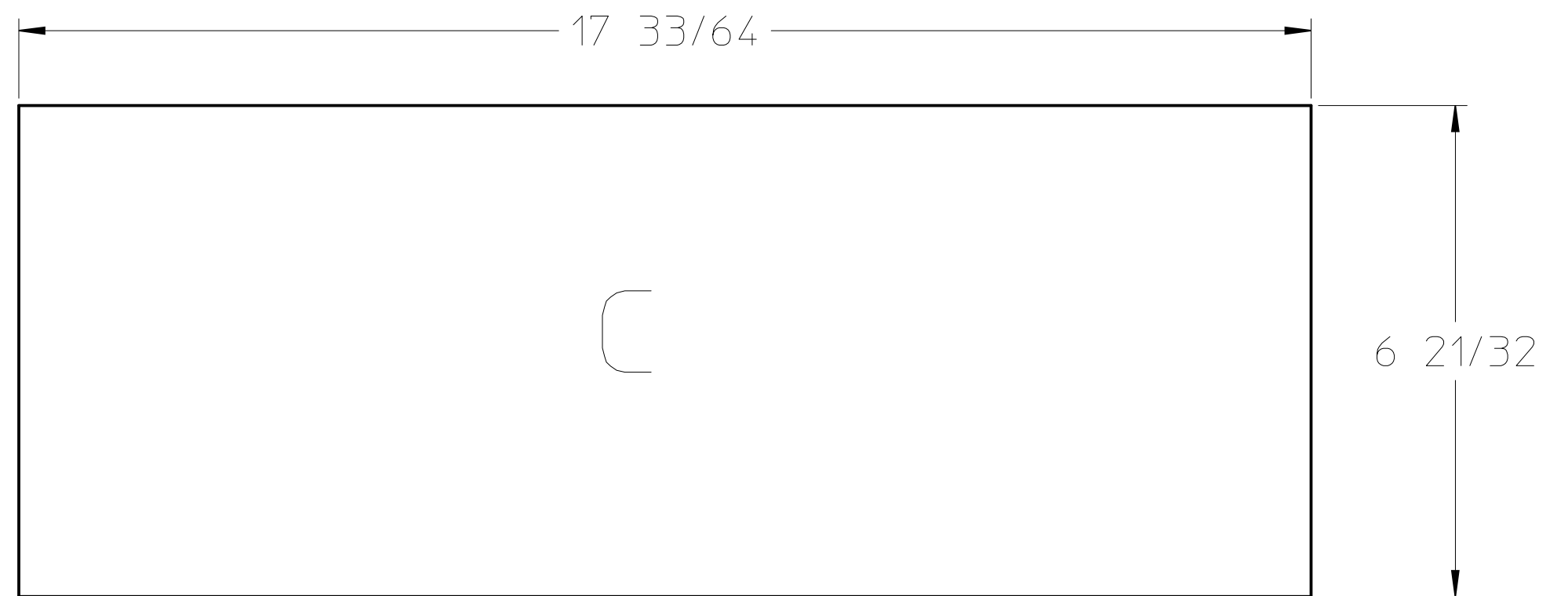
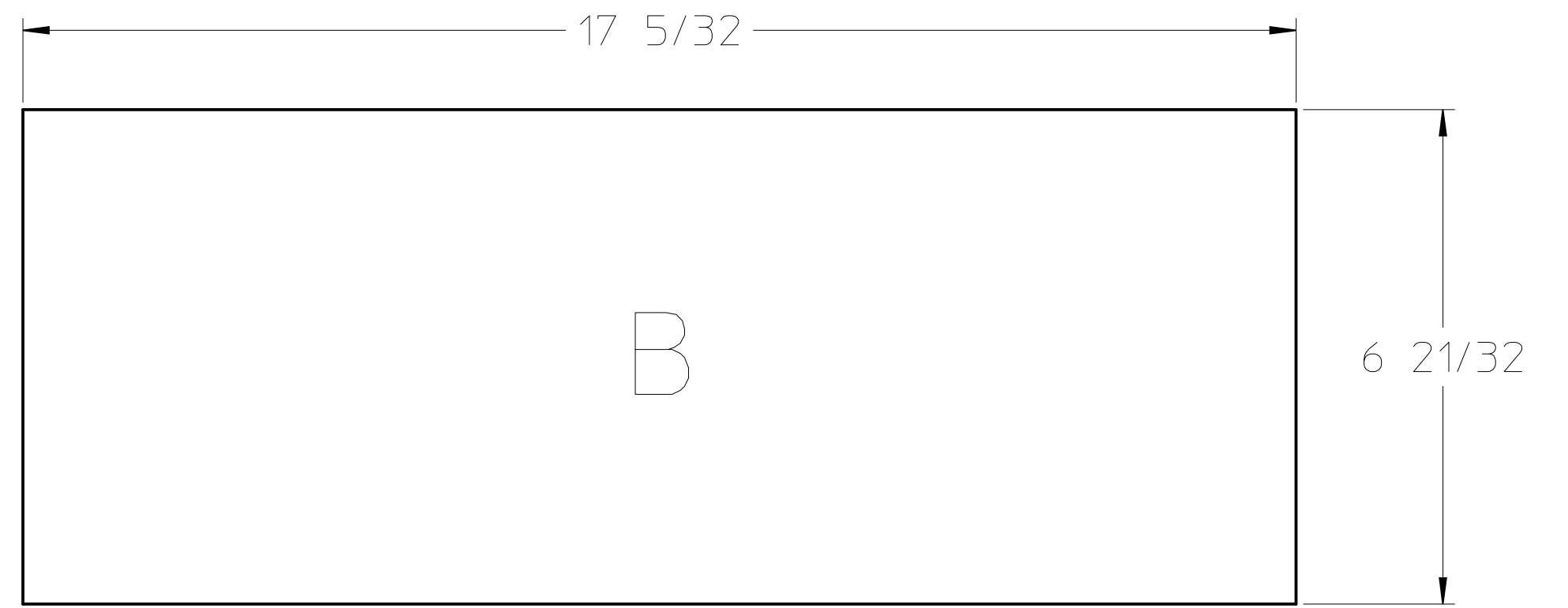
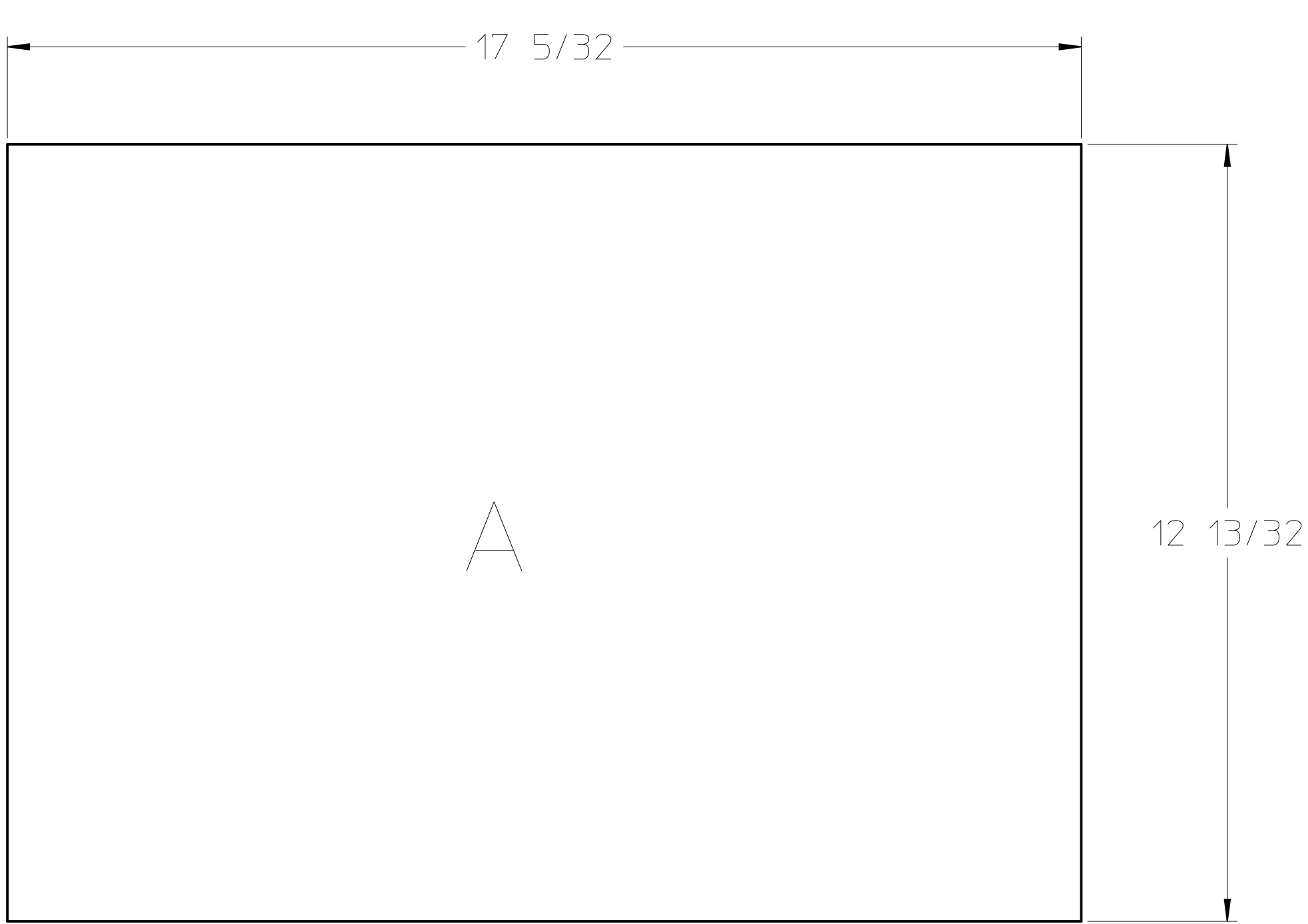

K
SCALE 5:1

NOTE:
1) VERTICAL DIVIDERS HAVE DADO'S CUT ON BOTH SIDES
2) SIDES WILL NEED TO BE CUT SUCH THAT THEY HAVE MIRRORED MATCHING SET

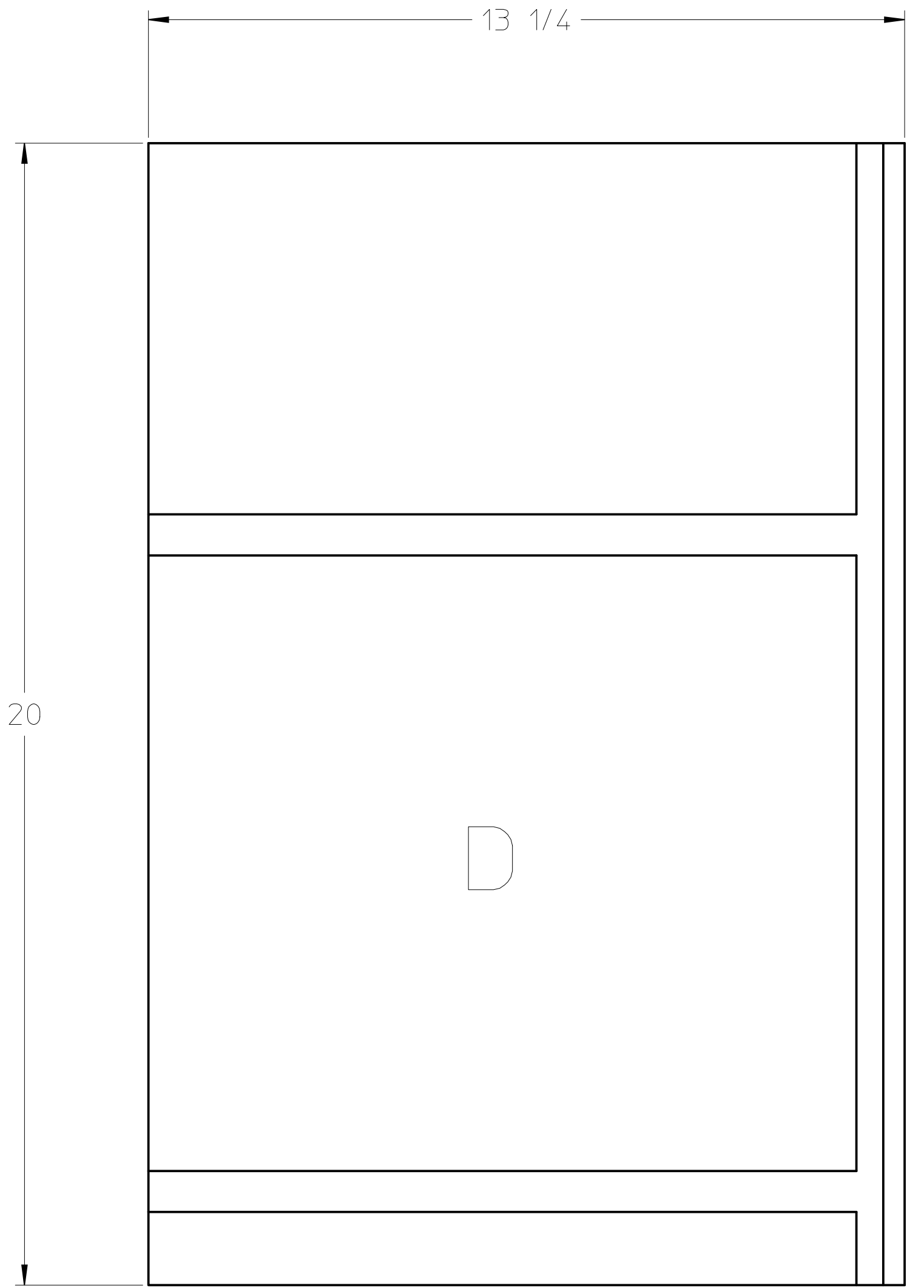
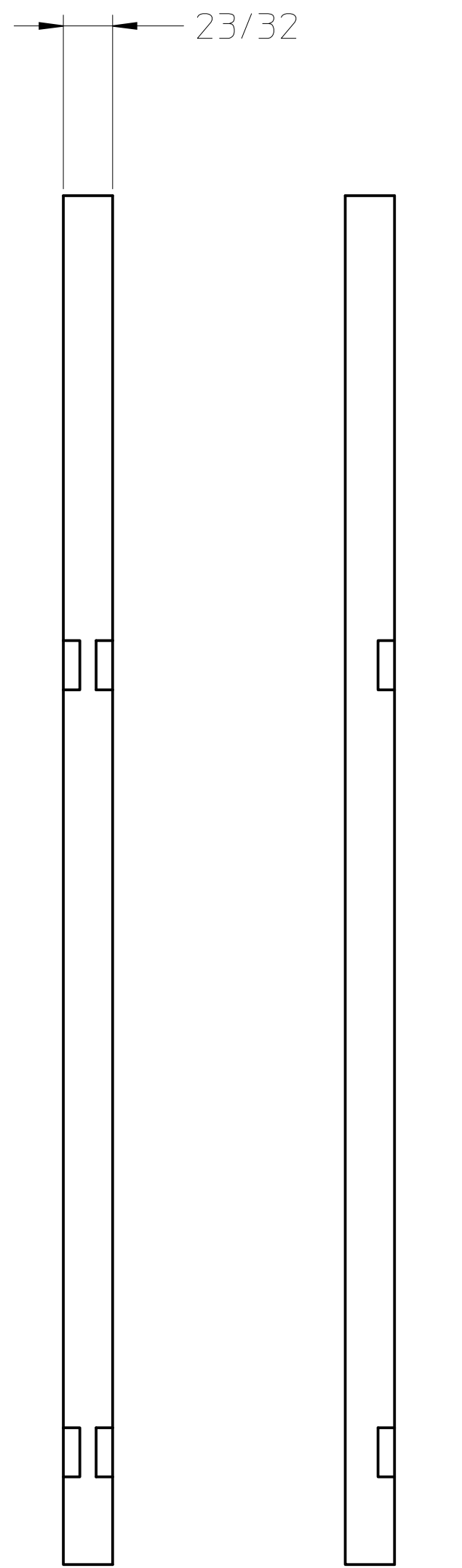
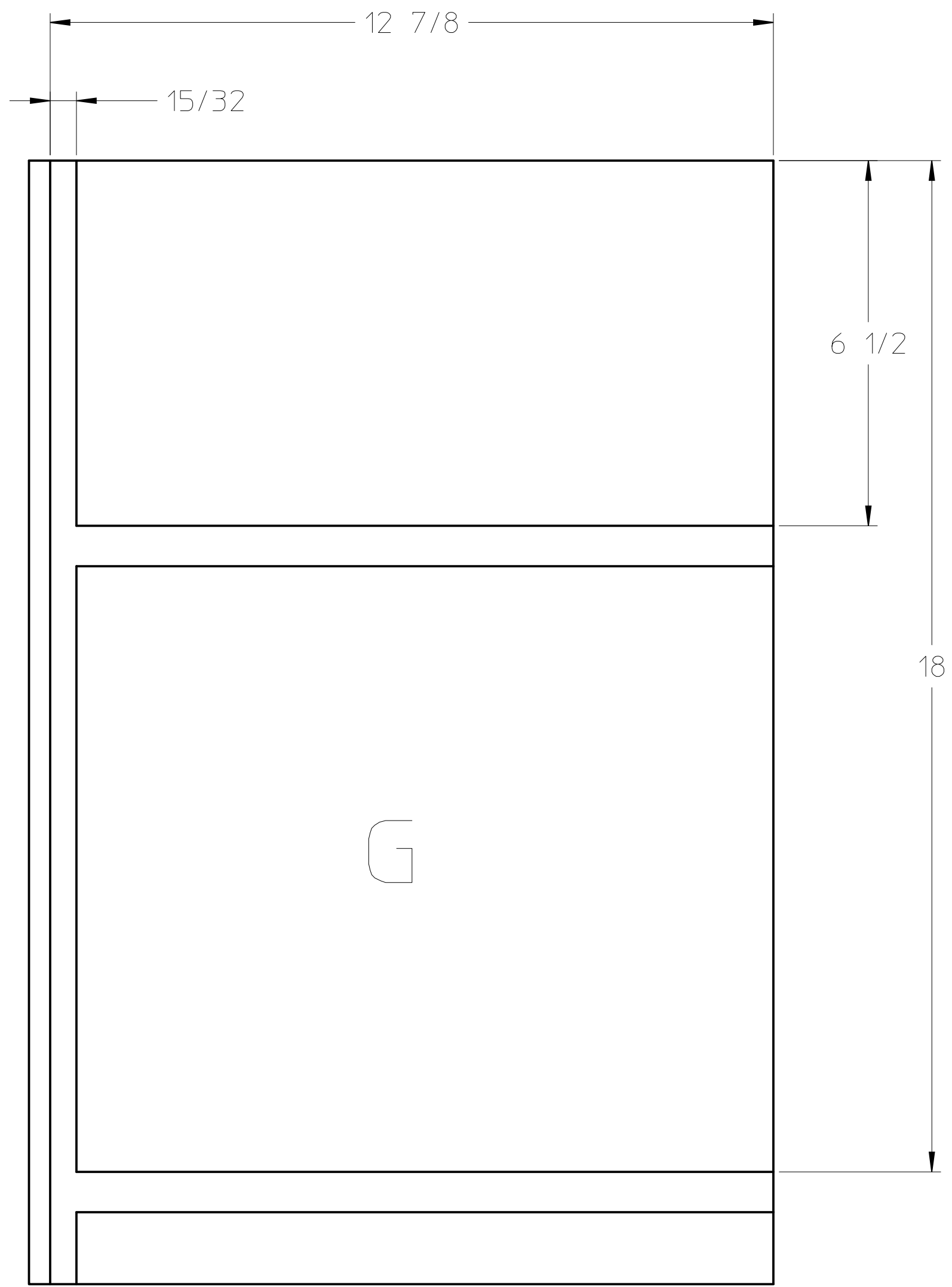

NOTE:

- 1) VERTICAL DIVIDERS HAVE DADO'S CUT ON BOTH SIDES
- 2) SIDES WILL NEED TO BE CUT SUCH THAT THEY HAVE MIRRORED MATCHING SET

17 5/32

17 33/64

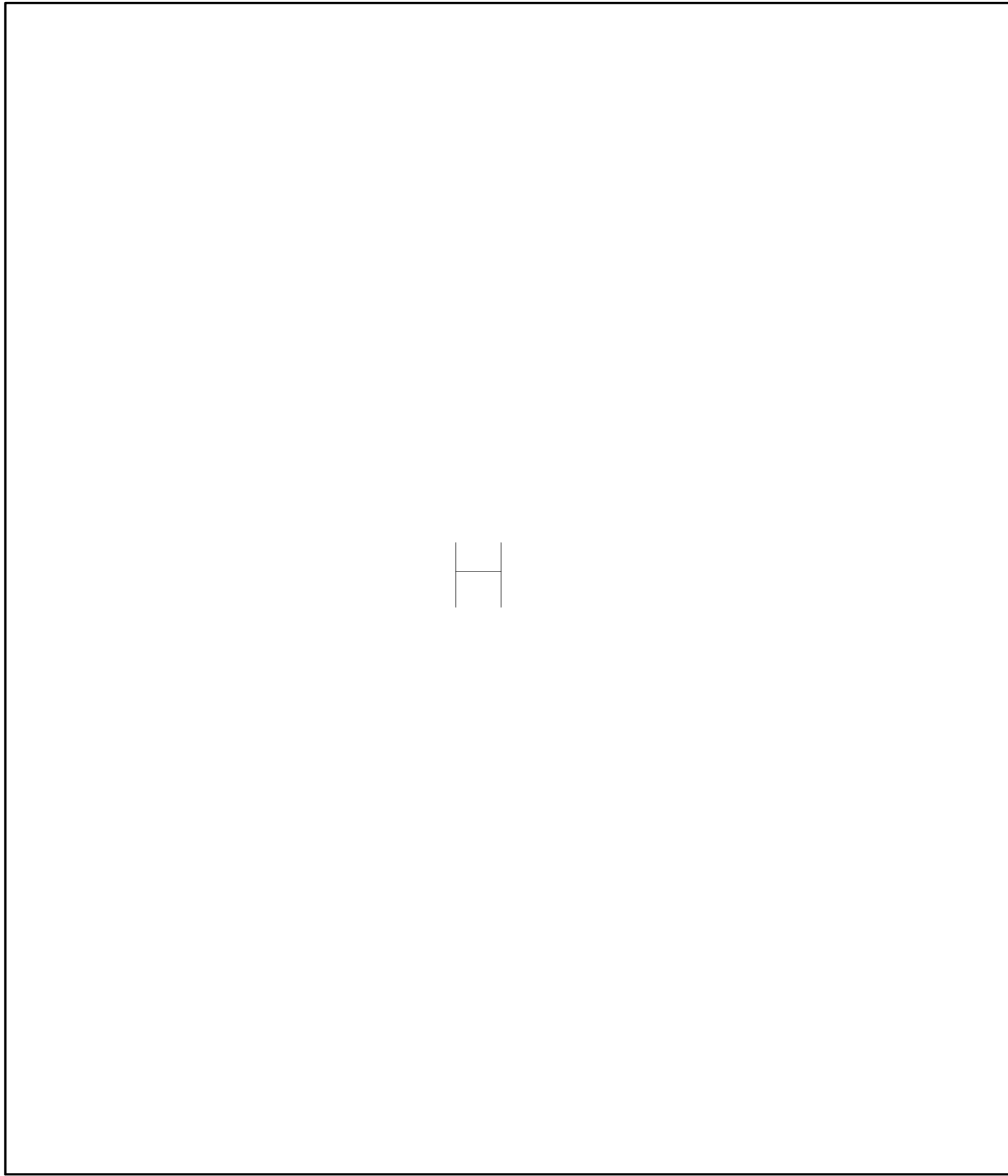

H

20

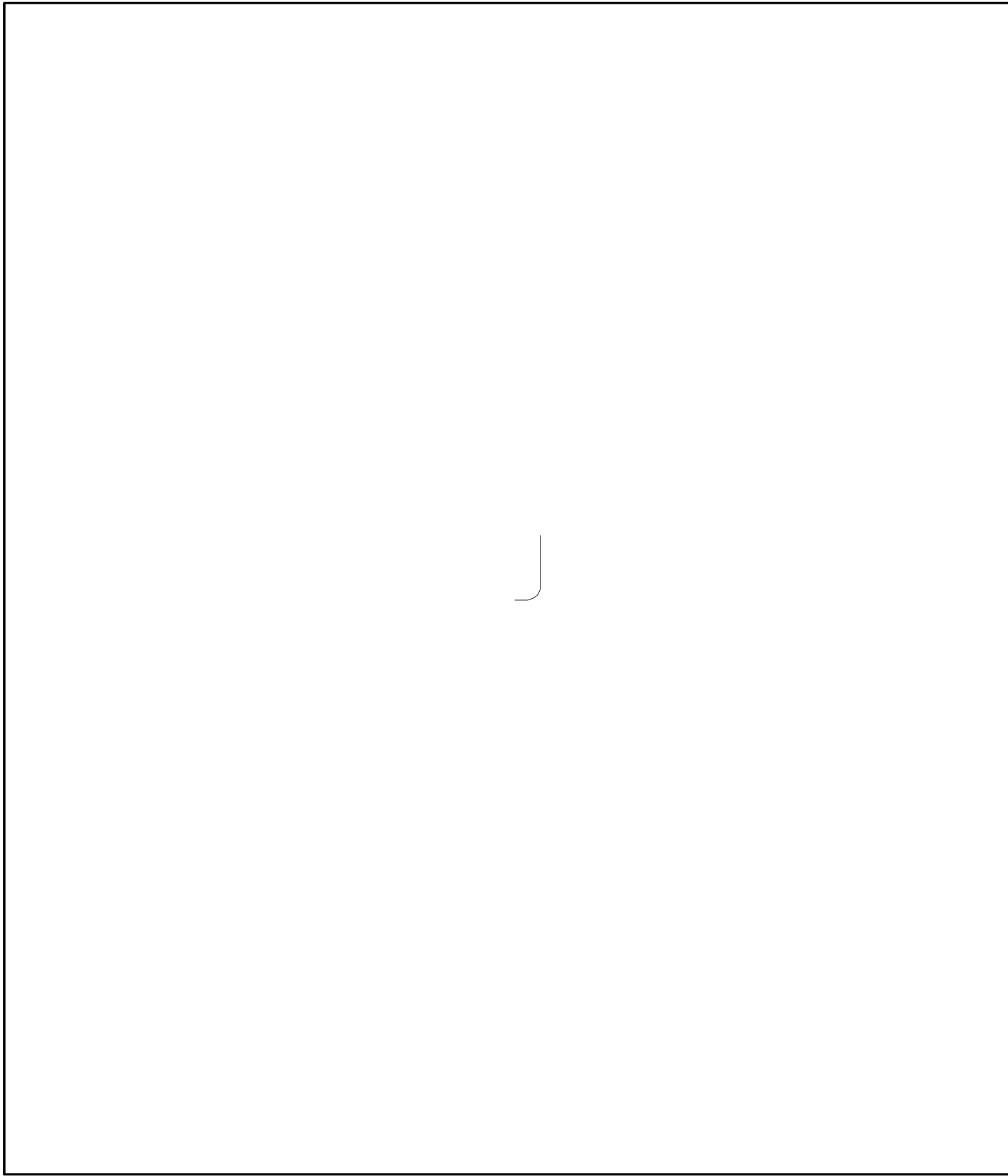

J

Backs

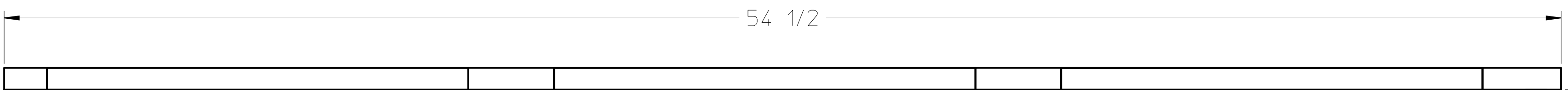

1 1/4

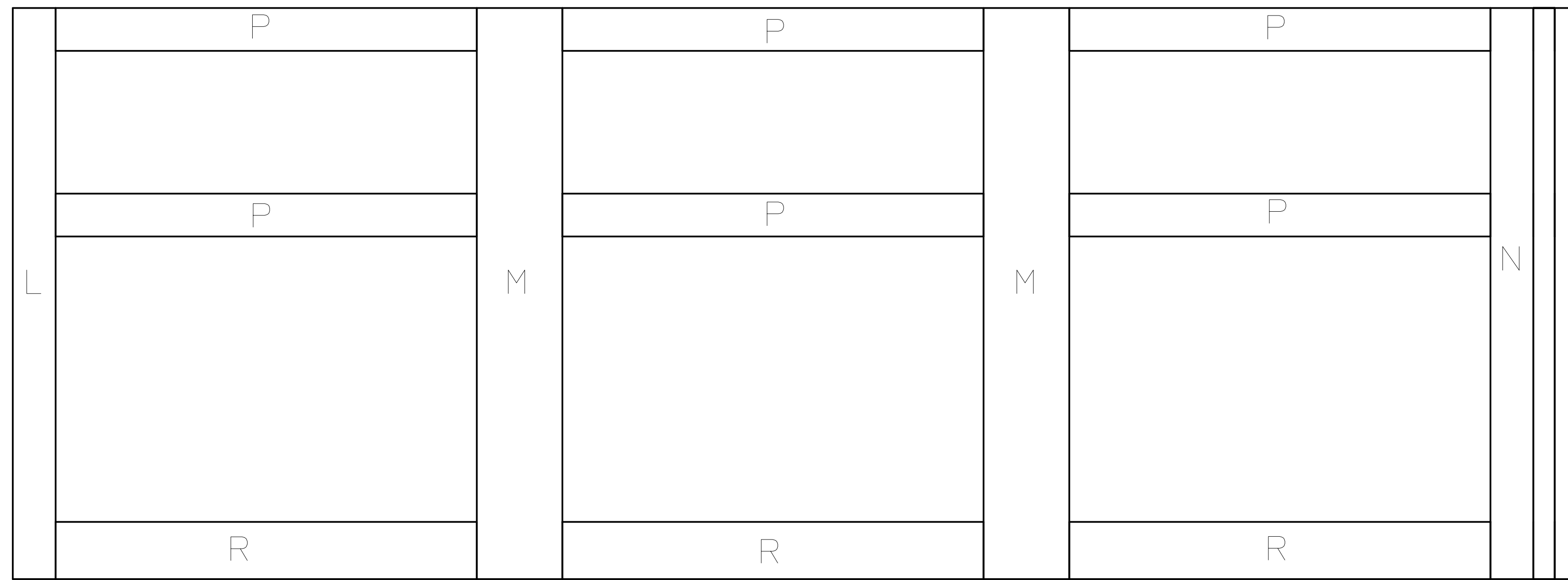

35 1/2

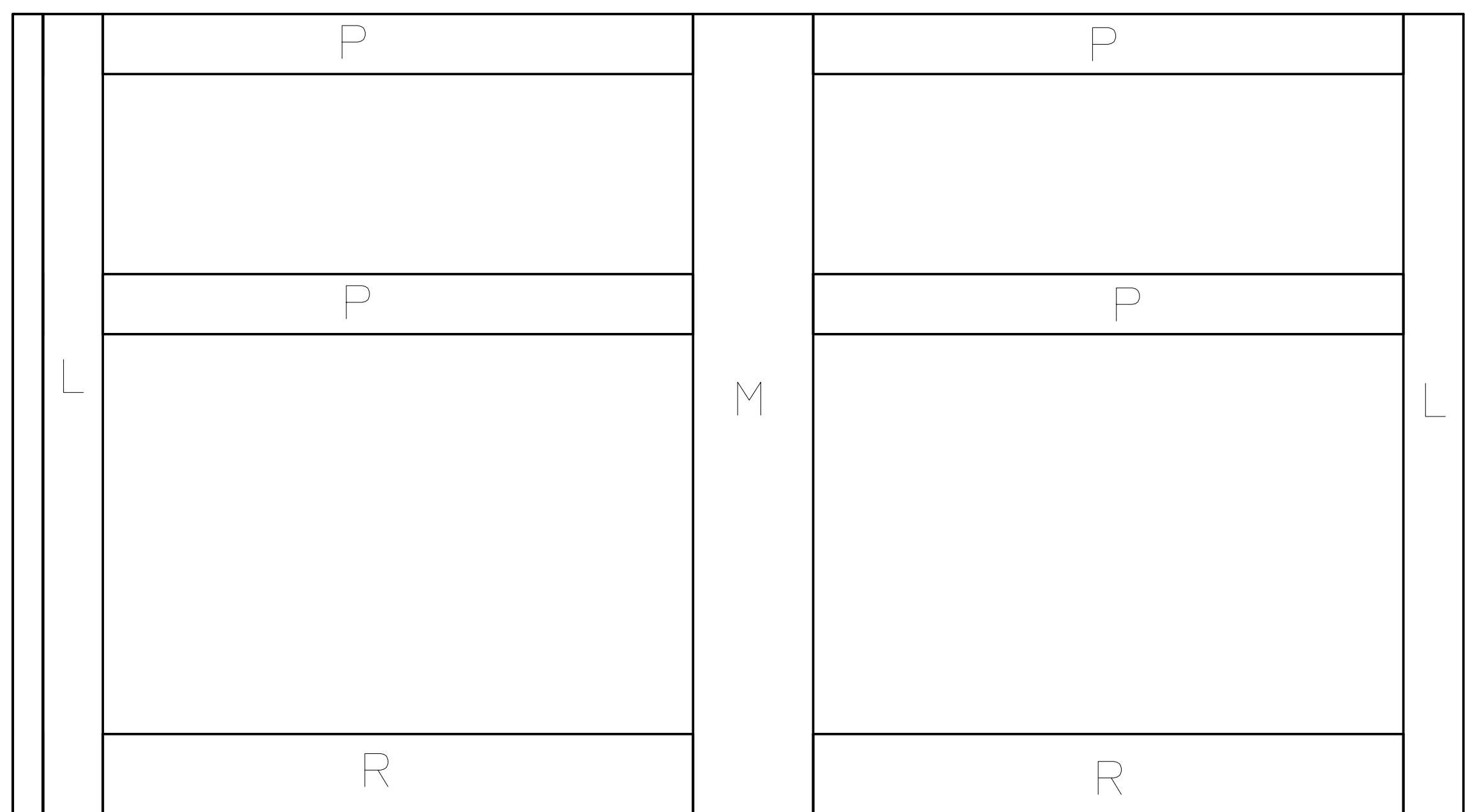

BOM: BENCH FACE FRAME

Pos	Qty	Part Name	DIMENSIONS	Material
L	3	Stile	20 X 1 1/2	3/4" HARDWOOD
M	3	Center Stile	20 X 3	3/4" HARDWOOD
N	1	Adjoining Stile	20 X 2 3/4	3/4" HARDWOOD
P	10	Rail	14 3/4 X 1 1/2	3/4" HARDWOOD
R	5	Lower Rail	14 3/4 X 2	3/4" HARDWOOD

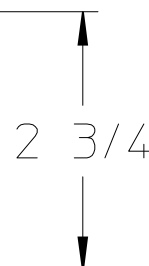
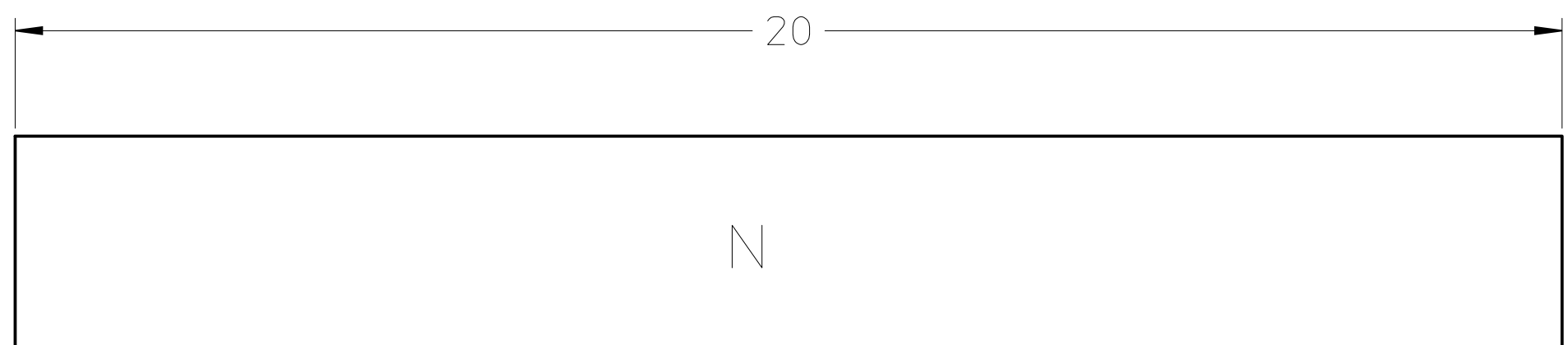
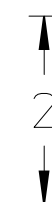
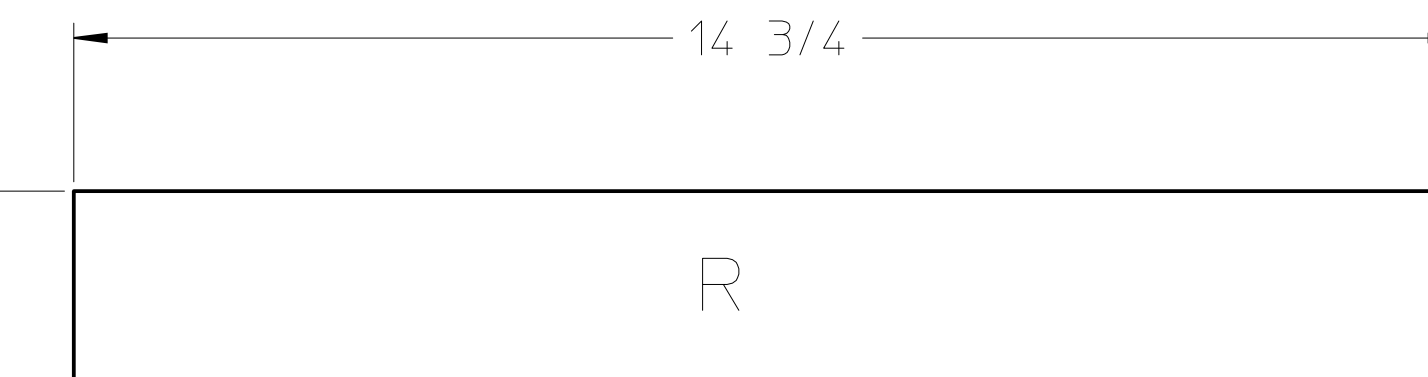
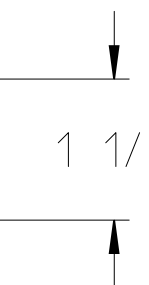
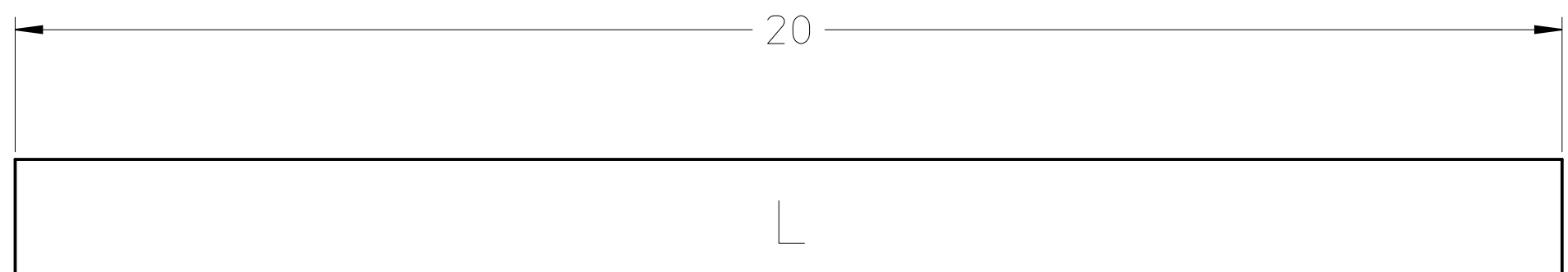
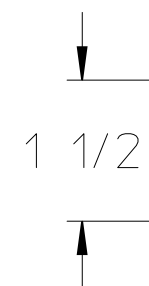
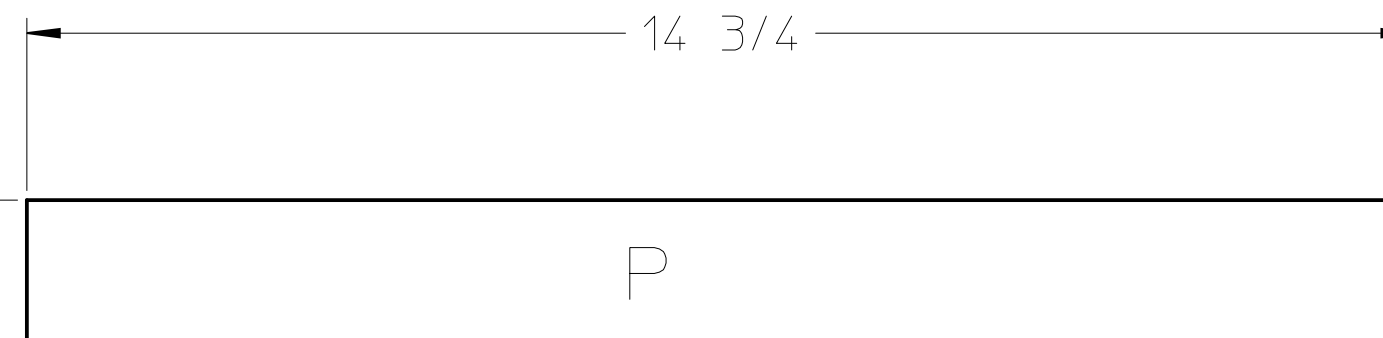
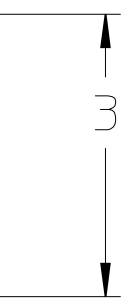
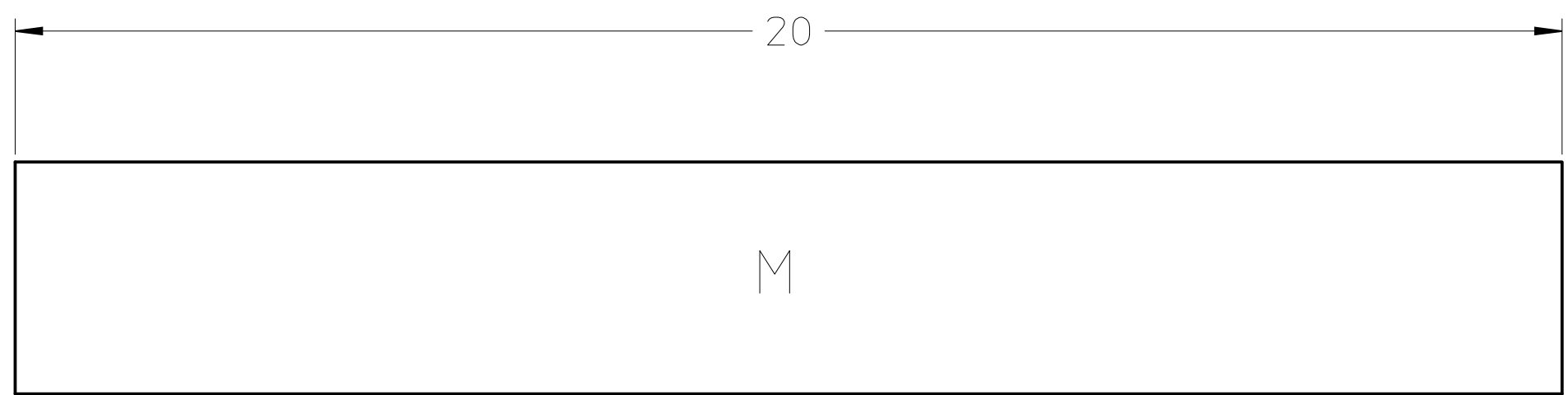

BOM: BENCH FACE FRAME

Pos	Qty	Part Name	DIMENSIONS	Material
L	3	Stile	20 X 1 1/2	3/4" HARDWOOD
M	3	Center Stile	20 X 3	3/4" HARDWOOD
N	1	Adjoining Stile	20 X 2 3/4	3/4" HARDWOOD
P	10	Rail	14 3/4 X 1 1/2	3/4" HARDWOOD
R	5	Lower Rail	14 3/4 X 2	3/4" HARDWOOD

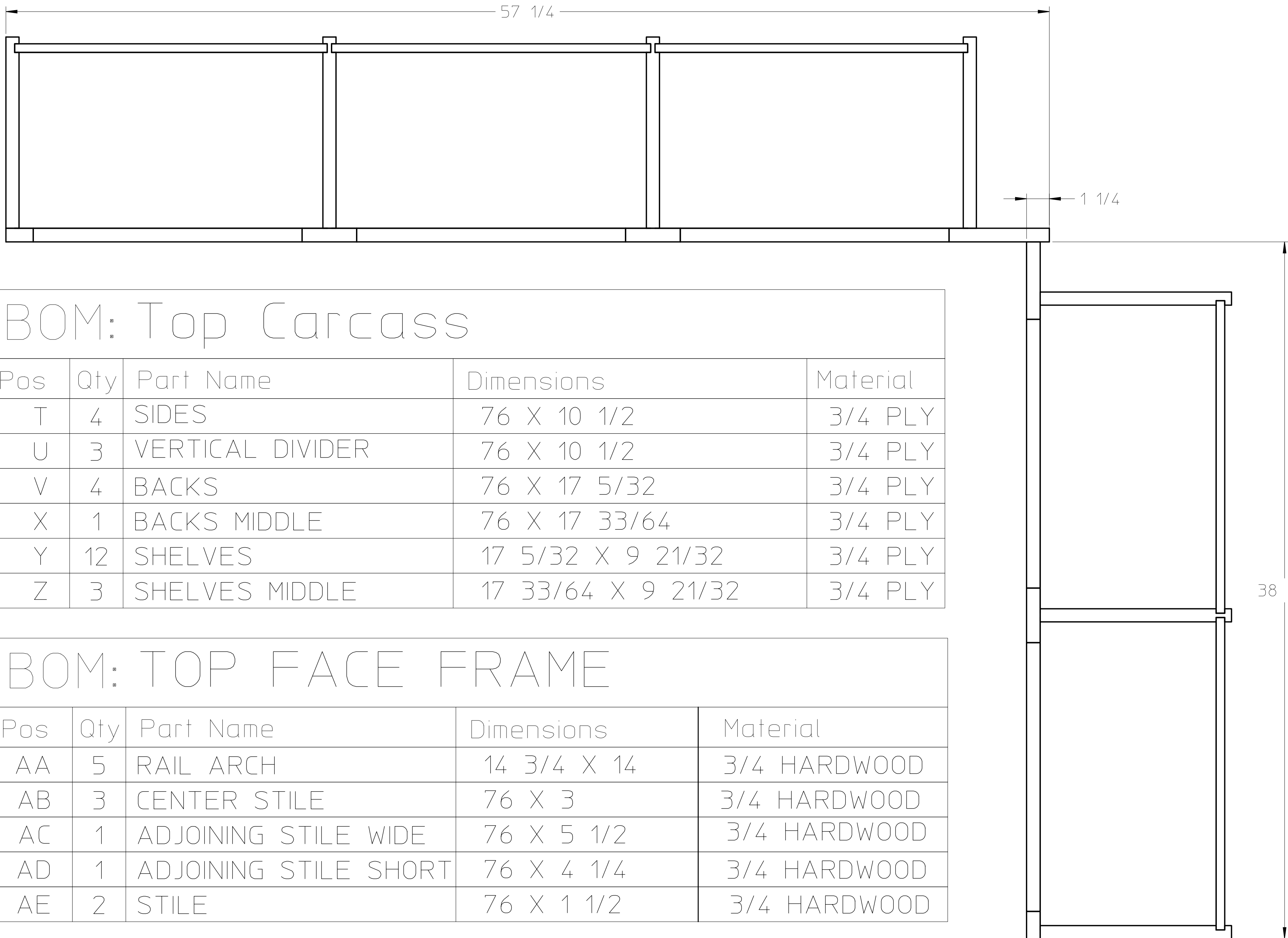

BOM: Top Carcass

Pos	Qty	Part Name	Dimensions	Material
T	4	SIDES	76 X 10 1/2	3/4 PLY
U	3	VERTICAL DIVIDER	76 X 10 1/2	3/4 PLY
V	4	BACKS	76 X 17 5/32	3/4 PLY
X	1	BACKS MIDDLE	76 X 17 33/64	3/4 PLY
Y	12	SHELVES	17 5/32 X 9 21/32	3/4 PLY
Z	3	SHELVES MIDDLE	17 33/64 X 9 21/32	3/4 PLY

BOM: TOP FACE FRAME

Pos	Qty	Part Name	Dimensions	Material
AA	5	RAIL ARCH	14 3/4 X 14	3/4 HARDWOOD
AB	3	CENTER STILE	76 X 3	3/4 HARDWOOD
AC	1	ADJOINING STILE WIDE	76 X 5 1/2	3/4 HARDWOOD
AD	1	ADJOINING STILE SHORT	76 X 4 1/4	3/4 HARDWOOD
AE	2	STILE	76 X 1 1/2	3/4 HARDWOOD

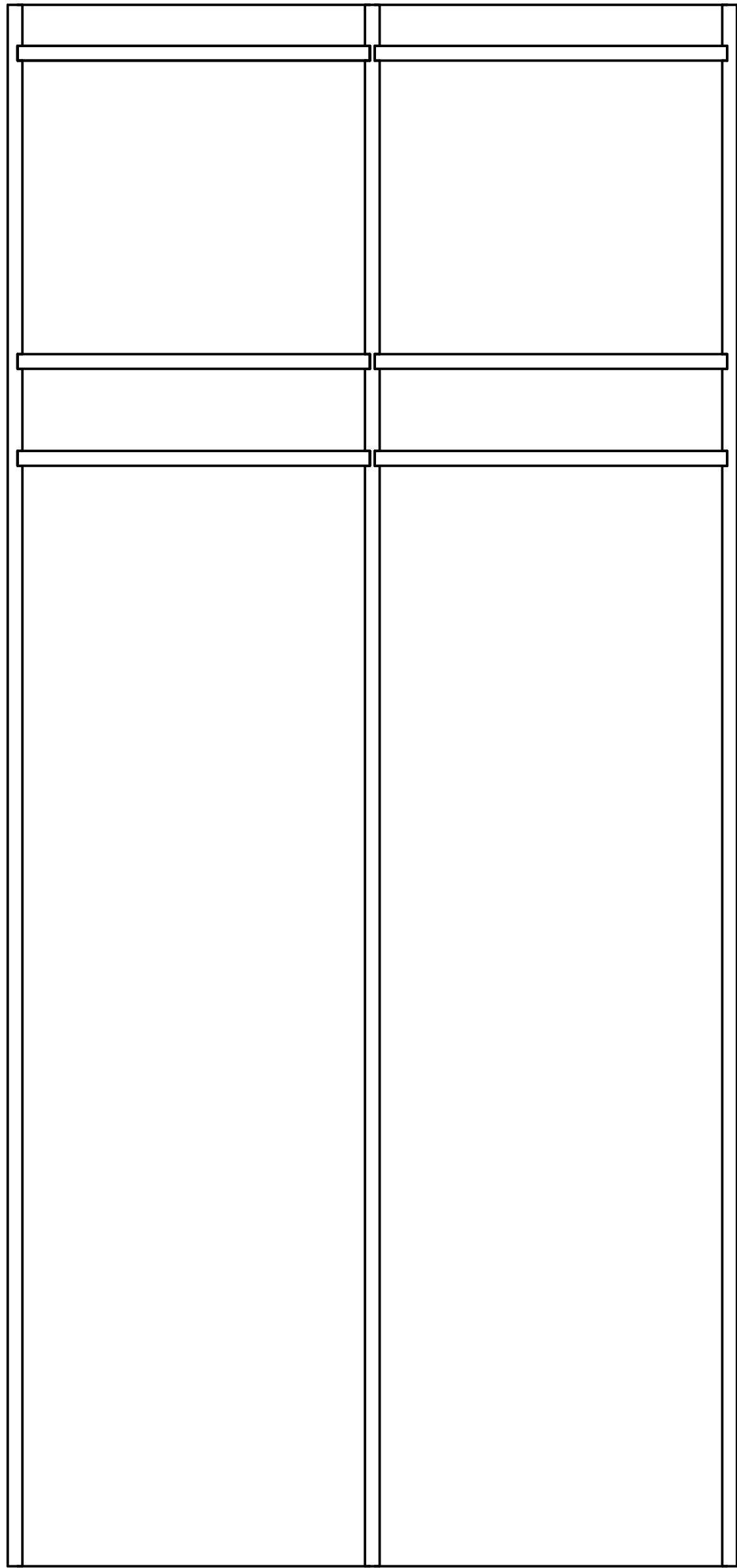

PARTIALY
SCALE 1:6

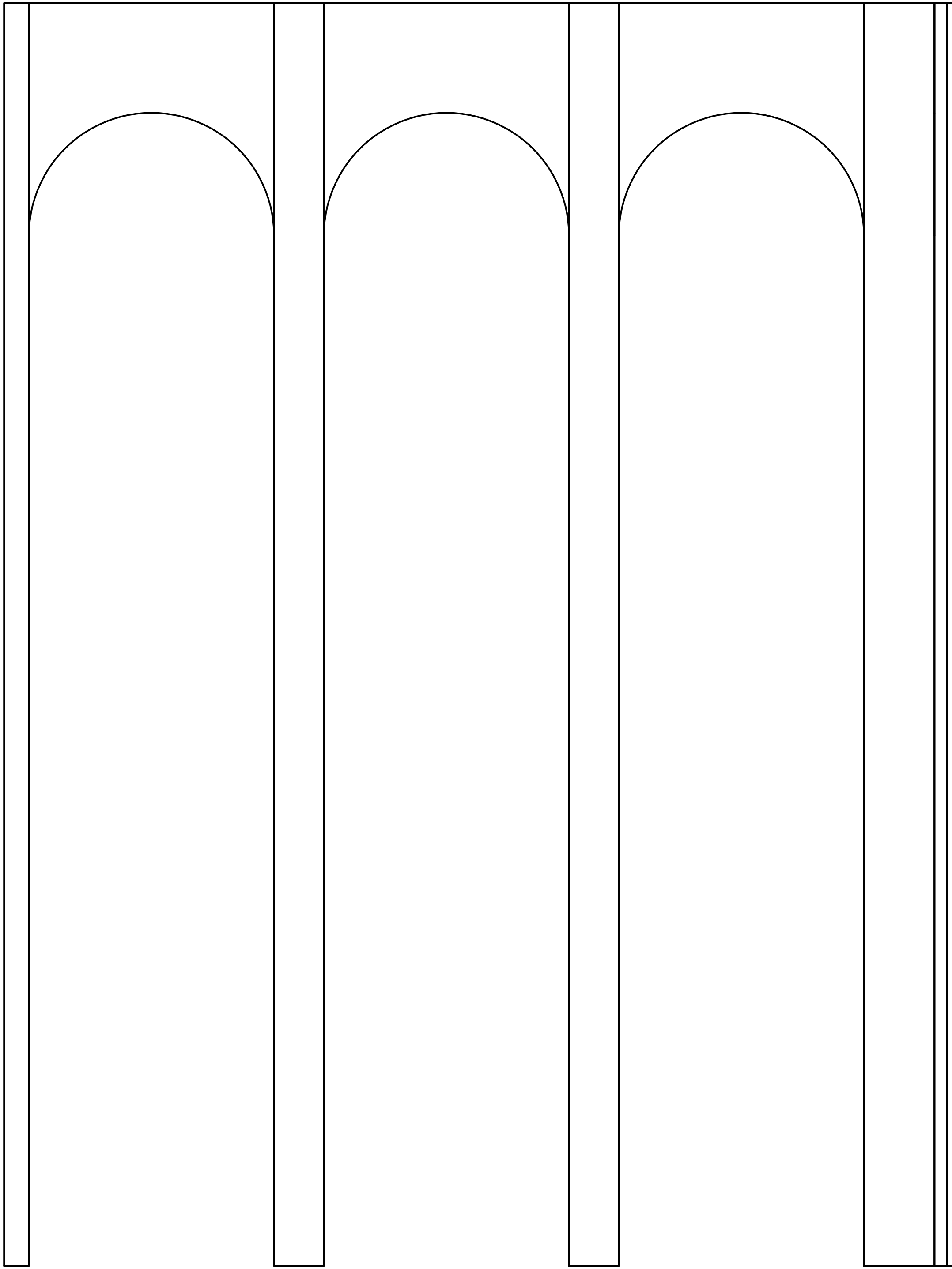

FRONT21

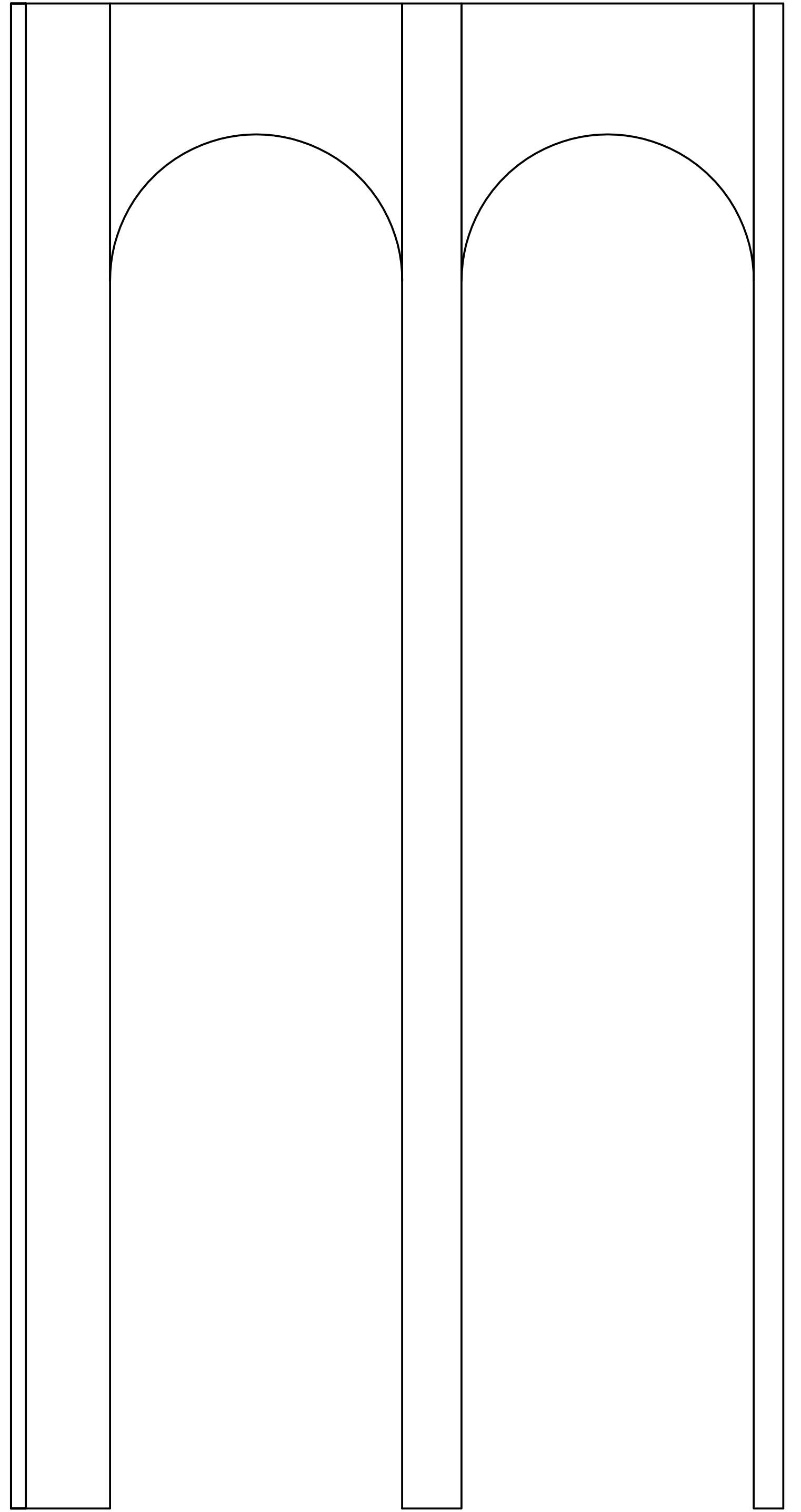

LEFT5

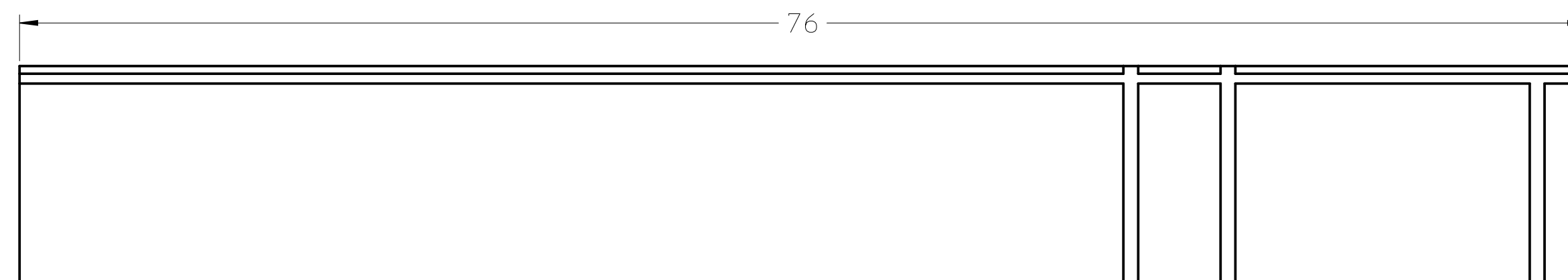
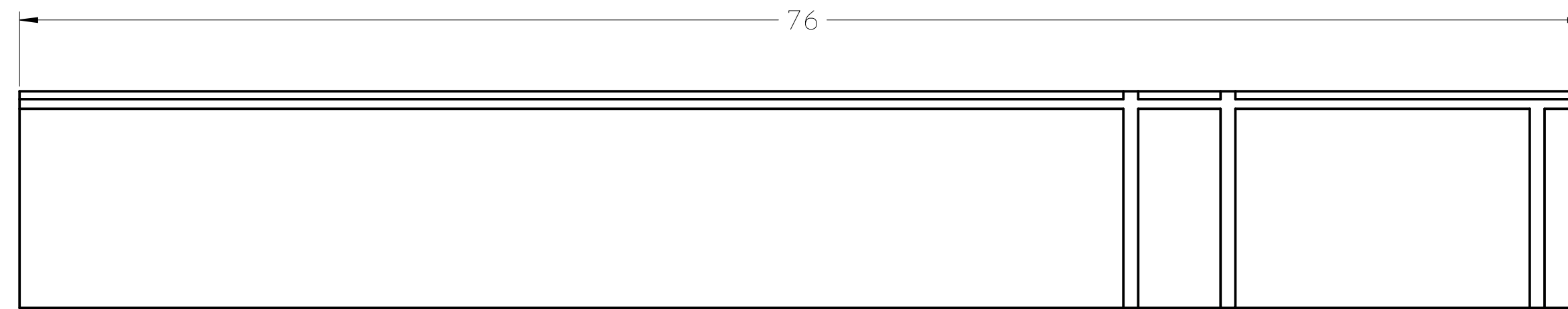
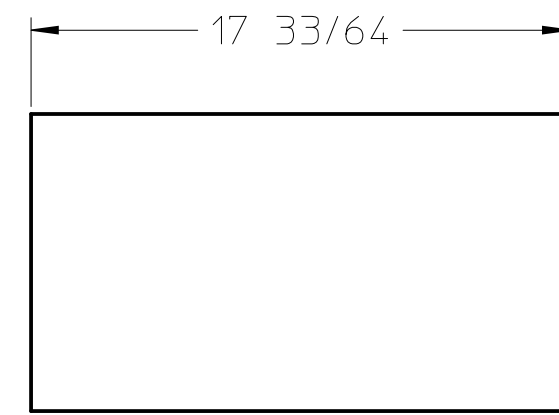
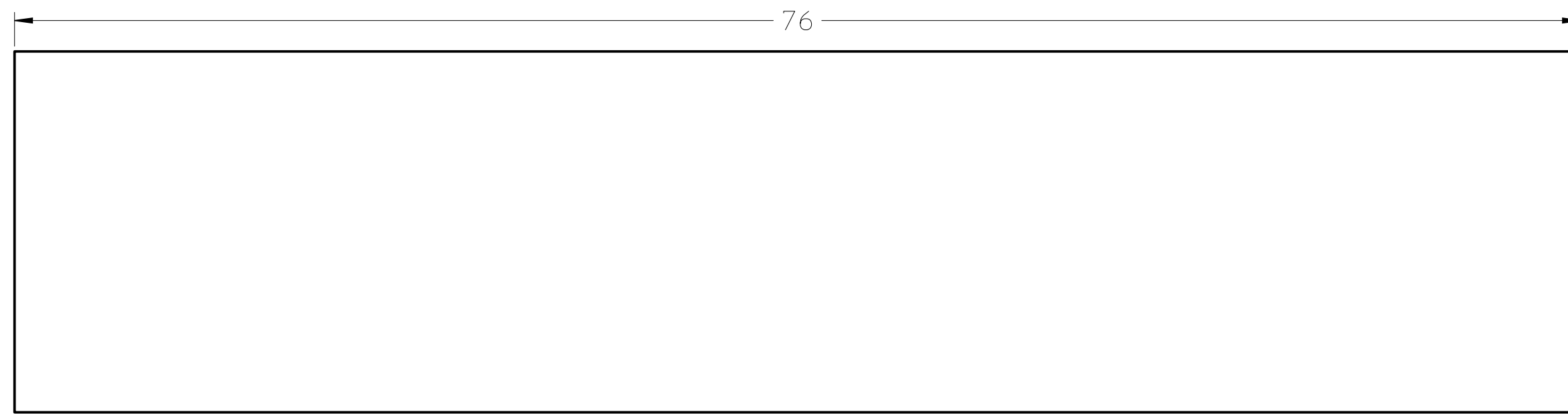
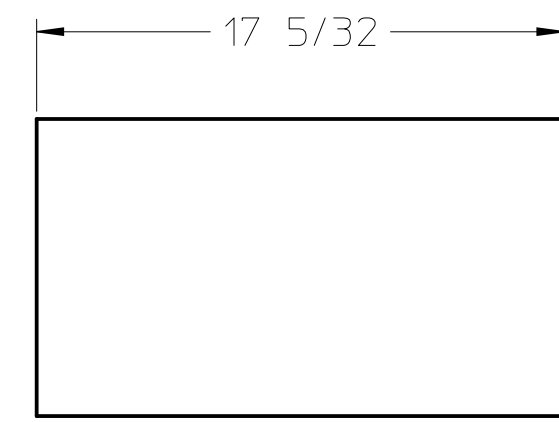
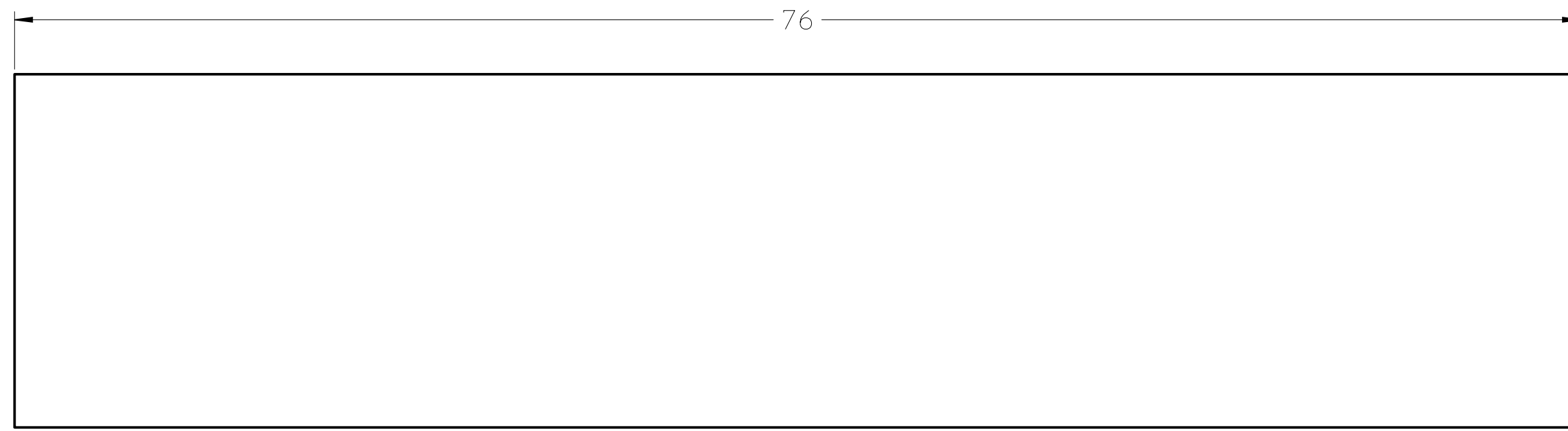

USE RANGE			TOLERANCE	SURFACE	ARCHIVE MATERIAL	SCALE 1:5
			DATE	NAME	DESCRIPTION	
			DRAWN			
			APPR.			
			RLS.			
					DRAWING-NUMBER Mudroom.Lockers	SHEET 14 OF 16
INDEX	DESCRIPTION	DATE	NAME	ORIGINAL	EXCH.F.	EXCH.TH.



4 1/4

FRONT32



5 1/2

FRONT31

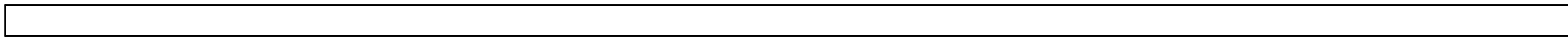

1 1/2

FRONT30



76



3

FRONT29

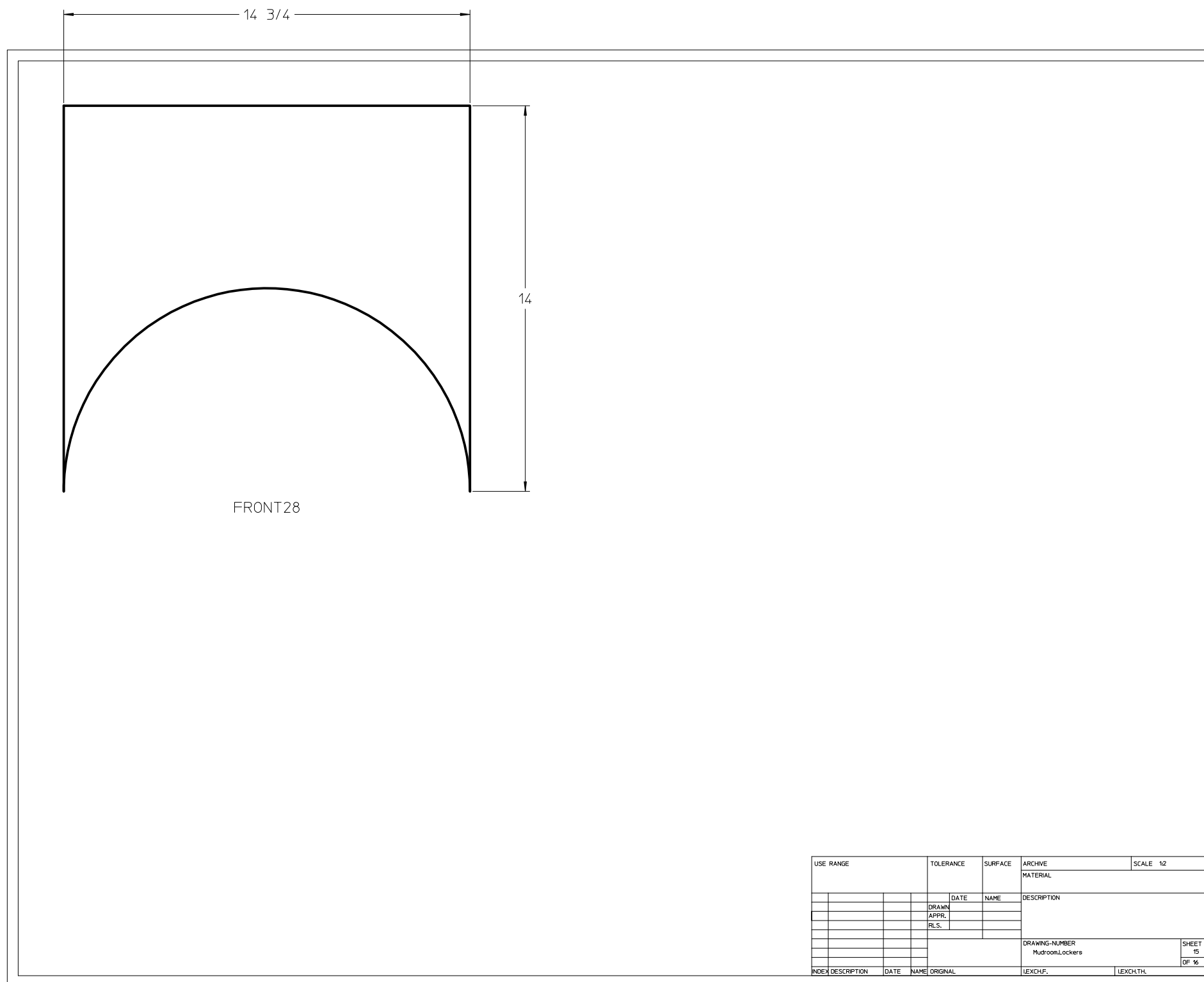

14 3/4

14

FRONT28

USE RANGE	TOLERANCE	SURFACE	ARCHIVE	SCALE 12
			MATERIAL	
	DATE	NAME	DESCRIPTION	
	DRAWN			
	CHECKED			
	DATE			
			DRAWING NUMBER	SHEET
			PLA/00AL/0004/09	15
				OF 16
INDEX DESCRIPTION	DATE	NAME ORIGINAL	LENGTH	

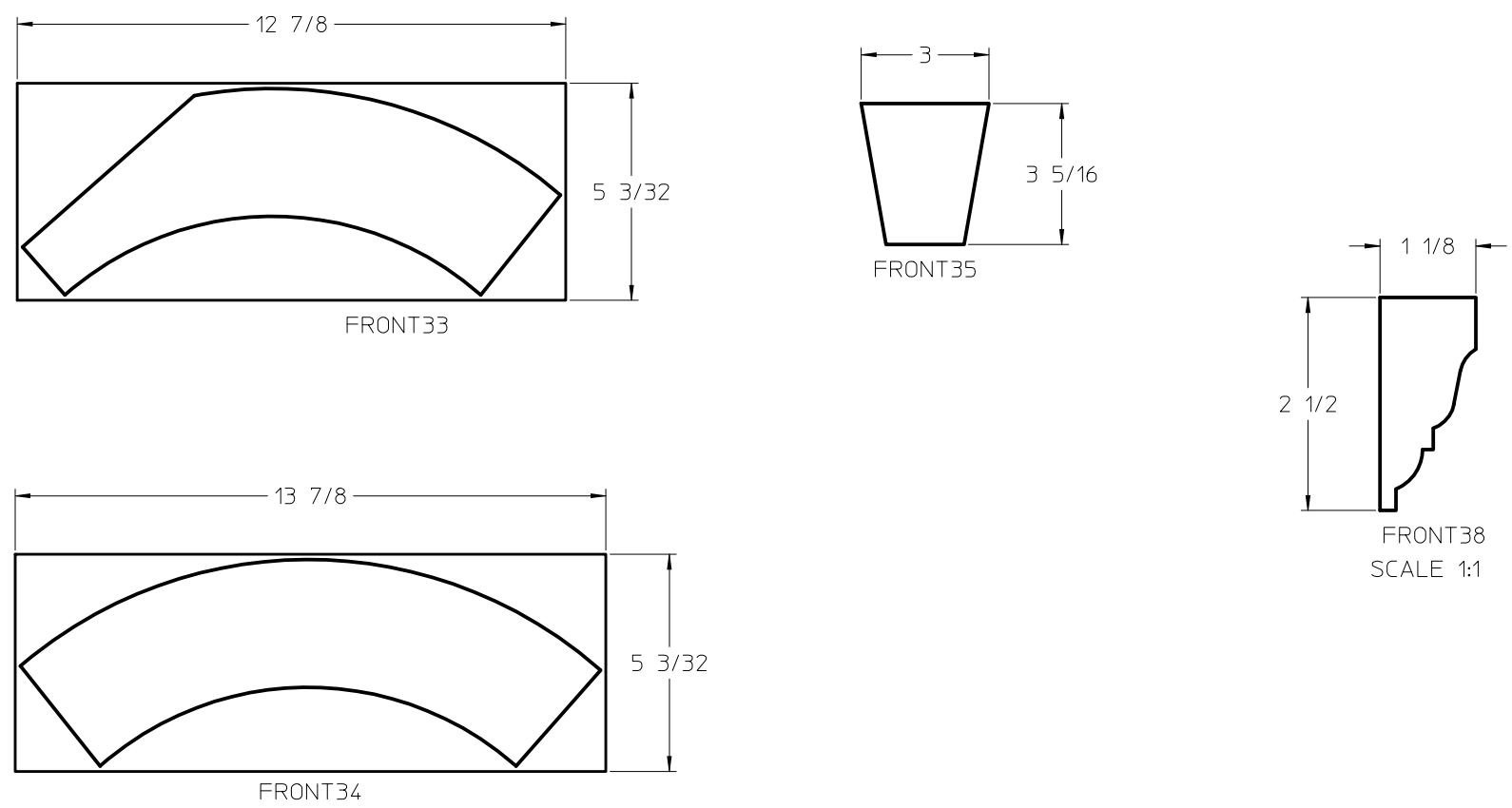
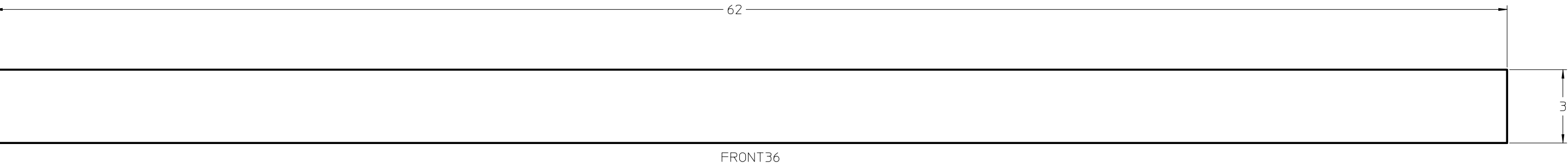
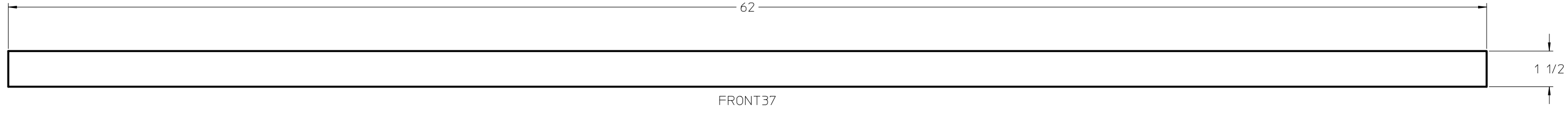

BOM: Trim

Pos	Qty	Part Name	Part No.	Material
5	5	CapStone.2	3 5/16 X 3	6/4 HARDWOOD
2	2	Arch.trim.full.1	13 7/8 X 5 3/32	4/4 HARDWOOD
8	8	Arch.trim.3	12 7/8 X 5 3/32	4/4 HARDWOOD
5	5	Trim Column.3.1	62 X 3	4/4 HARDWOOD
2	2	Column.trim.thin.1	62 X 1 1/2	4/4 HARDWOOD
1	1	CROWN MOULDING	96 X 2 1/2	6/4 HARDWOOD

USER	RANGE	TOLERANCE	SURFACE	ARCHIVE	SCALE
					1:2
DATE	NAME	DESCRIPTION			
DRAWN					
CHECKED					
DATE	NAME	DESCRIPTION			
DRAWING-NUMBER	DRAWING-NUMBER		SHEET		
PL00000000	PL00000000		16		
			OF	16	
INDEX DESCRIPTION	DATE	NAME ORIGINAL	REVISION	REVISION	

Parts List

[x]	Part #	Sub-Assembly	Description	Copies	# Cut	Thick	Width	Length	Material Type	Material Name	Bandin g	<Info >	Diagram #s
[]	1	Bench Seat	[Panel] Seat long	3	0	7/8"	5 5/64"	53"	Rough Lumber	Oak, Red	N/A		
^^Notes: [Glued-Up Panel: 52 1/2" x 14 3/4" (finished). Qty: 1.]													
[]	2	Bench Seat	[Panel] Seat Short	3	0	7/8"	5 5/64"	50"	Rough Lumber	Oak, Red	N/A		
^^Notes: [Glued-Up Panel: 49 1/2" x 14 3/4" (finished). Qty: 1.]													
[]	3	Bench Seat	Drawer Fronts	5	0	3/4"	4 3/4"	14 1/2"	Rough Lumber	Poplar	N/A		
[]	4	Bench Face frame	Stile	3	0	3/4"	1 1/2"	20"	Rough Lumber	Poplar	N/A		
[]	5	Bench Face frame	Center Stile	3	0	3/4"	3"	20"	Rough Lumber	Poplar	N/A		
[]	6	Bench Face frame	Adjoining Stile	1	0	3/4"	2 3/4"	20"	Rough Lumber	Poplar	N/A		
[]	7	Bench Face frame	Rail	10	0	3/4"	1 1/2"	14 3/4"	Rough Lumber	Poplar	N/A		
[]	8	Bench Face frame	Lower Rail	5	0	3/4"	2"	14 3/4"	Rough Lumber	Poplar	N/A		
[]	9	Top Face Frame	[Panel] Rail Arch	15	0	3/4"	4 53/64"	15 1/4"	Rough Lumber	Poplar	N/A		
^^Notes: [Glued-Up Panel: 14 3/4" x 14" (finished). Qty: 5.]													
[]	10	Top Face Frame	Center Stile	3	0	3/4"	3"	76"	Rough Lumber	Poplar	N/A		
[]	11	Top Face Frame	Adjoining Stile Wide	1	0	3/4"	5 1/2"	76"	Rough Lumber	Poplar	N/A		
[]	12	Top Face Frame	Adjoining Stile Short	1	0	3/4"	4 1/4"	76"	Rough Lumber	Poplar	N/A		
[]	13	Top Face Frame	Stile	2	0	3/4"	1 1/2"	76"	Rough Lumber	Poplar	N/A		
[]	14	Top Trim	Cap Stone	5	0	1"	3"	3 5/16"	Rough Lumber	Poplar	N/A		
[]	15	Top Trim	Arch Full	2	0	3/4"	5 3/32"	13 7/8"	Rough Lumber	Poplar	N/A		
[]	16	Top Trim	Arch	8	0	3/4"	5 3/32"	12 7/8"	Rough Lumber	Poplar	N/A		
[]	17	Top Trim	Column	5	0	3/4"	3"	62"	Rough Lumber	Poplar	N/A		
[]	18	Top Trim	Column Thin	2	0	3/4"	1 1/2"	62"	Rough Lumber	Poplar	N/A		
[]	19	Top Trim	Crown Moulding	1	0	3/4"	2 1/2"	96"	Rough Lumber	Poplar	N/A		

[x]	Part #	Sub-Assembly	Description	Copies	# Cut	Thick	Width	Length	Material Type	Material Name	Bandin g	<Info >	Diagram #s
[]	20	Bench Carcass	Shelves	4	0	3/4"	12 13/32"	17 5/32"	Sheet Good	Birch	None		B2, B3
[]	21	Bench Carcass	Narrow Shelves	4	0	3/4"	6 21/32"	17 5/32"	Sheet Good	Birch	None		B1
[]	22	Bench Carcass	Narrow Shelves Middle	2	0	3/4"	6 21/32"	17 33/64"	Sheet Good	Birch	None		B1
[]	23	Bench Carcass	Sides	2	0	3/4"	13 3/4"	20"	Sheet Good	Birch	None		B3
[]	24	Bench Carcass	Narrow Sides	2	0	3/4"	7 1/8"	20"	Sheet Good	Birch	None		B1
[]	25	Bench Carcass	Narrow Vertical Divider	2	0	3/4"	7 1/8"	20"	Sheet Good	Birch	None		B1
[]	26	Bench Carcass	Vertical Divider	1	0	3/4"	13 1/4"	20"	Sheet Good	Birch	None		B3
[]	27	Bench Carcass	Backs	4	0	1/2"	17 5/32"	20"	Sheet Good	Birch	None		A3
[]	28	Bench Carcass	Middle Backs	1	0	1/2"	17 33/64"	20"	Sheet Good	Birch	None		A1
[]	29	Top Carcass	Sides	4	0	3/4"	10 1/2"	76"	Sheet Good	Birch	None		B2
[]	30	Top Carcass	Vertical Divider	3	0	3/4"	10 1/2"	76"	Sheet Good	Birch	None		B3
[]	31	Top Carcass	Backs	4	0	1/2"	17 5/32"	76"	Sheet Good	Birch	None		A2
[]	32	Top Carcass	Middle Backs	1	0	1/2"	17 33/64"	76"	Sheet Good	Birch	None		A3
[]	33	Top Carcass	Shelves	12	0	3/4"	9 21/32"	17 5/32"	Sheet Good	Birch	None		B1, B2, B3
[]	34	Top Carcass	Middle Shelves	3	0	3/4"	9 21/32"	17 33/64"	Sheet Good	Birch	None		B3

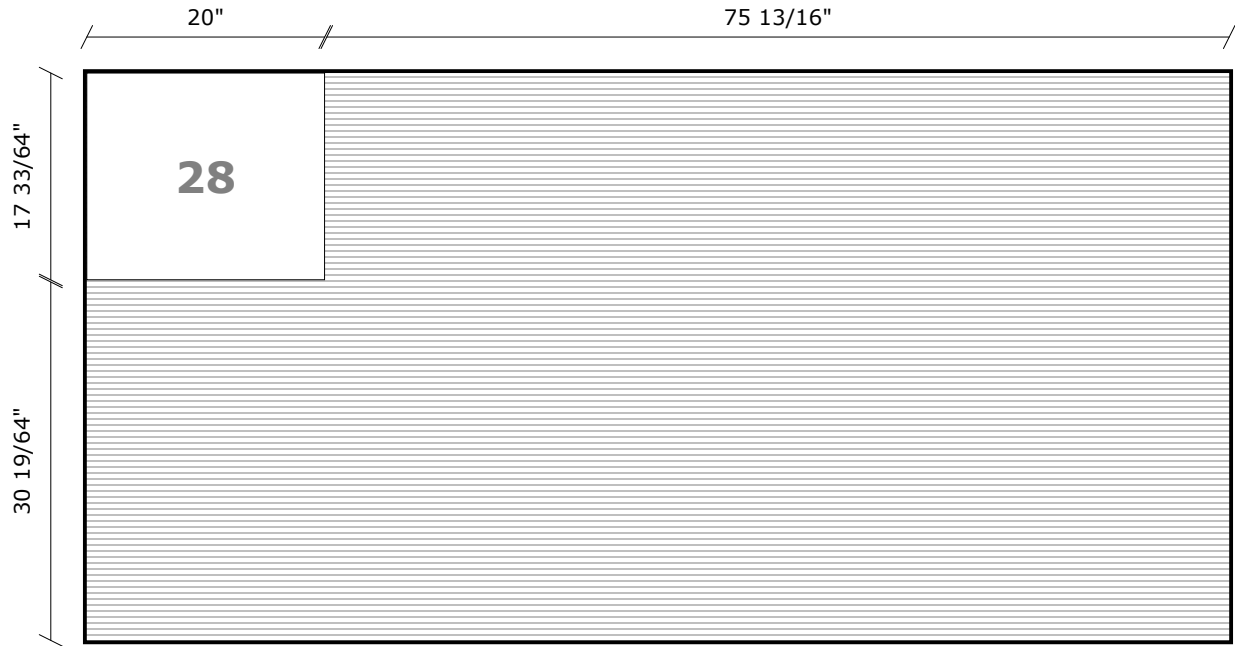

[A1] Birch: 1/2" x 96" x 48"

Vendor: Bin:

[] 1 of 3 this size	Qty this diag.: 1	Grain: Horizontal	Stock Trim: 0"::0"	Standard Layout
Kerf: 3/16"	Part Padding: 0"	Waste: 92.4%	Final Cut Dimensions	

Part #	Sub-Assembly	Description	Copies in Layout	Thick	Final Cut Y	Final Cut X	Rough Y	Rough X	Banding	<Info>
28	Bench Carcass	Middle Backs	1	1/2"	17 33/64"	20"	17 33/64"	20"	None	

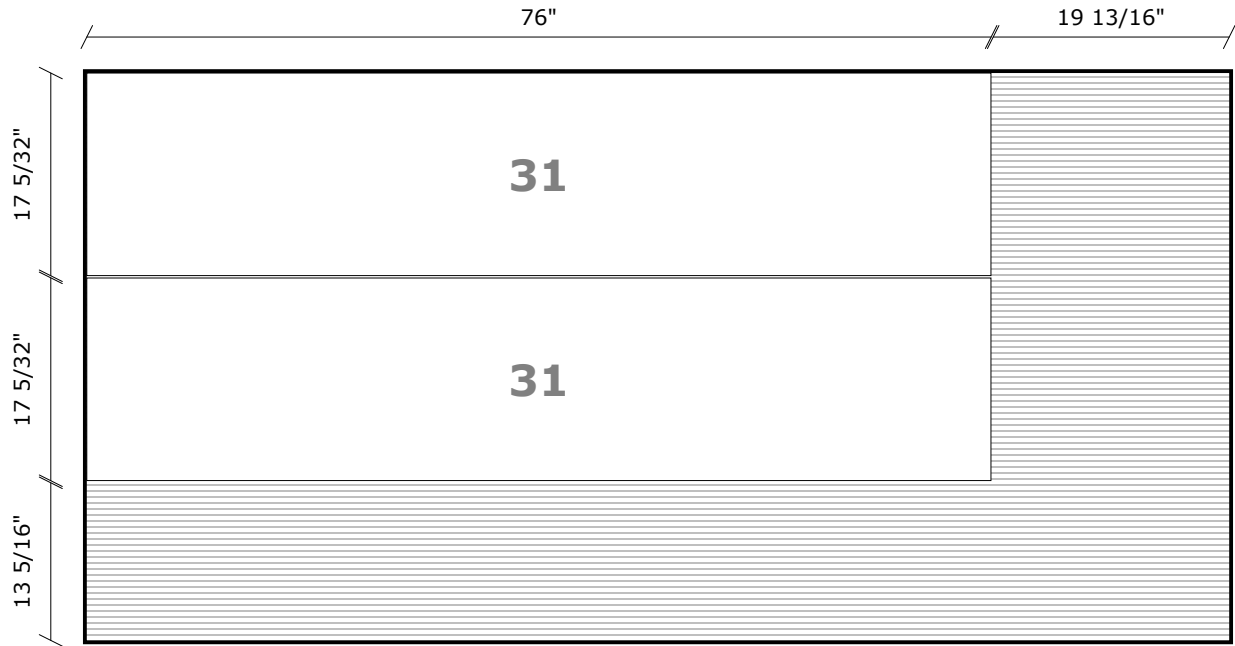

[A2] Birch: 1/2" x 96" x 48"

Vendor: Bin:

[] 2 of 3 this size Qty this diag.: 2 Grain: Horizontal Stock Trim: 0"::0" Standard Layout

Kerf: 3/16" Part Padding: 0" Waste: 43.4% Final Cut Dimensions

Part #	Sub-Assembly	Description	Copies in Layout	Thick	Final Cut Y	Final Cut X	Rough Y	Rough X	Banding	<Info>
31	Top Carcass	Backs	2	1/2"	17 5/32"	76"	17 5/32"	76"	None	

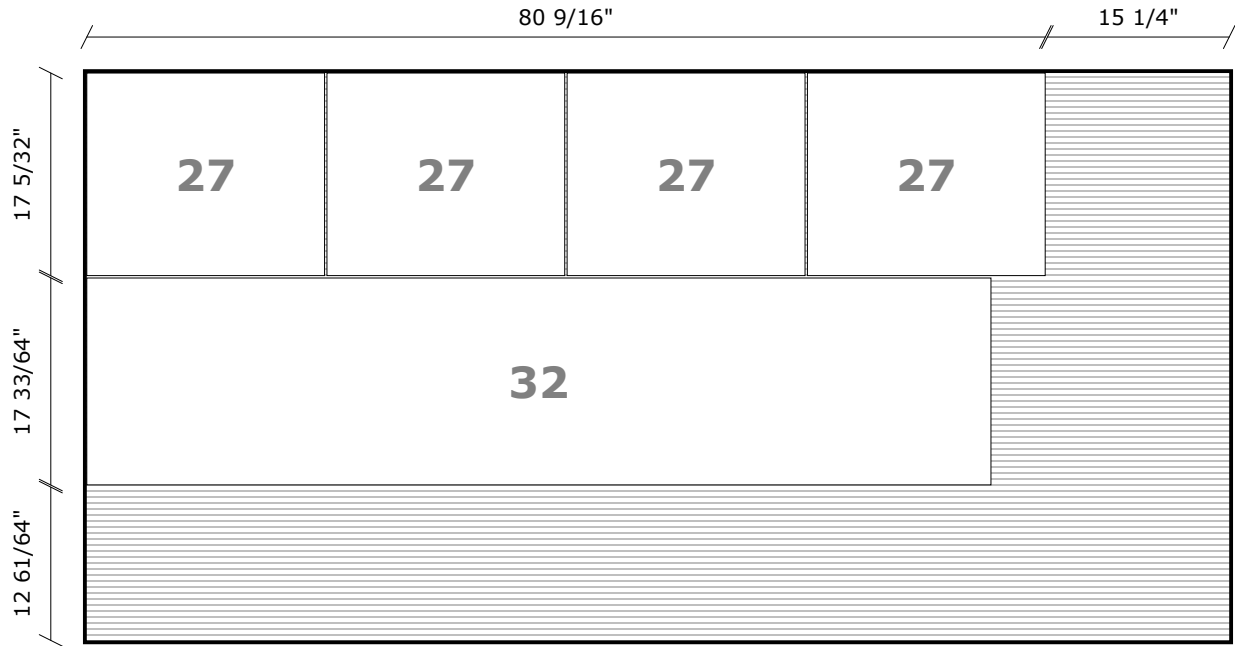

[A3] Birch: 1/2" x 96" x 48"

Vendor: Bin:

[] 3 of 3 this size Qty this diag.: 1 Grain: Horizontal Stock Trim: 0"::0" Standard Layout

Kerf: 3/16" Part Padding: 0" Waste: 41.3% Final Cut Dimensions

Part #	Sub-Assembly	Description	Copies in Layout	Thick	Final Cut Y	Final Cut X	Rough Y	Rough X	Banding	<Info>
27	Bench Carcass	Backs	4	1/2"	17 5/32"	20"	17 5/32"	20"	None	
32	Top Carcass	Middle Backs	1	1/2"	17 33/64"	76"	17 33/64"	76"	None	

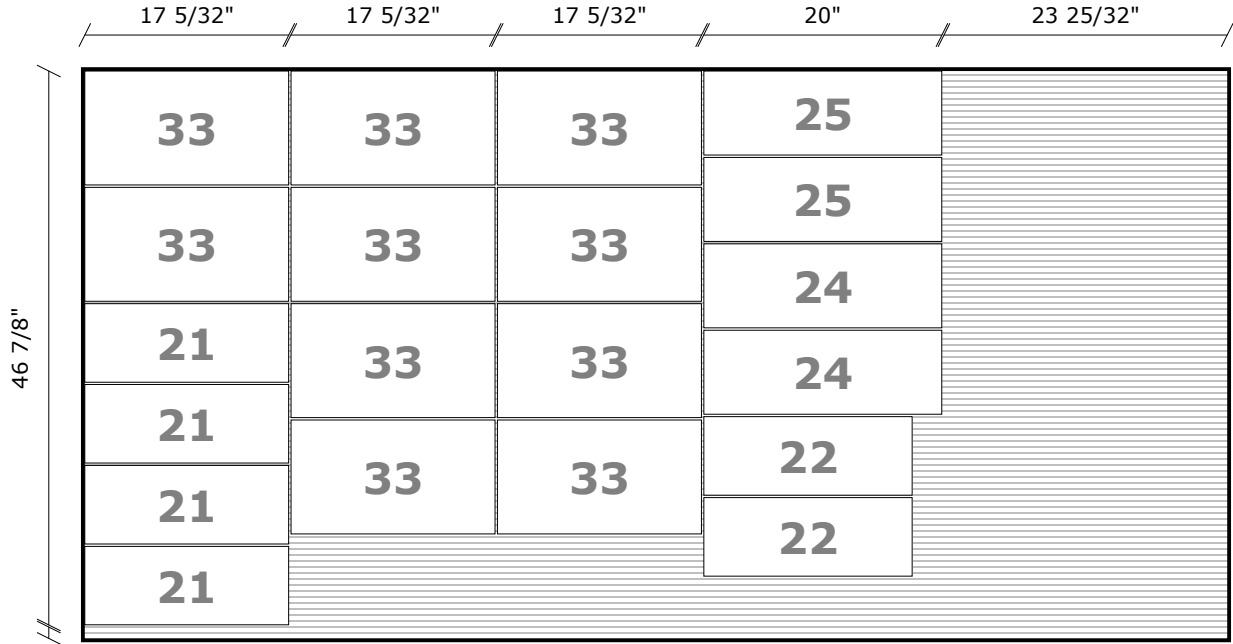

[B1] Birch: 3/4" x 96" x 48"

Vendor: Bin:

[] 1 of 3 this size Qty this diag.: 1 Grain: Horizontal Stock Trim: 0"::0" Standard Layout

Kerf: 3/16" Part Padding: 0" Waste: 36.7% Final Cut Dimensions

Part #	Sub-Assembly	Description	Copies in Layout	Thick	Final Cut Y	Final Cut X	Rough Y	Rough X	Banding	<Info>
21	Bench Carcass	Narrow Shelves	4	3/4"	6 21/32"	17 5/32"	6 21/32"	17 5/32"	None	
22	Bench Carcass	Narrow Shelves Middle	2	3/4"	6 21/32"	17 33/64"	6 21/32"	17 33/64"	None	
24	Bench Carcass	Narrow Sides	2	3/4"	7 1/8"	20"	7 1/8"	20"	None	
25	Bench Carcass	Narrow Vertical Divider	2	3/4"	7 1/8"	20"	7 1/8"	20"	None	
33	Top Carcass	Shelves	10	3/4"	9 21/32"	17 5/32"	9 21/32"	17 5/32"	None	

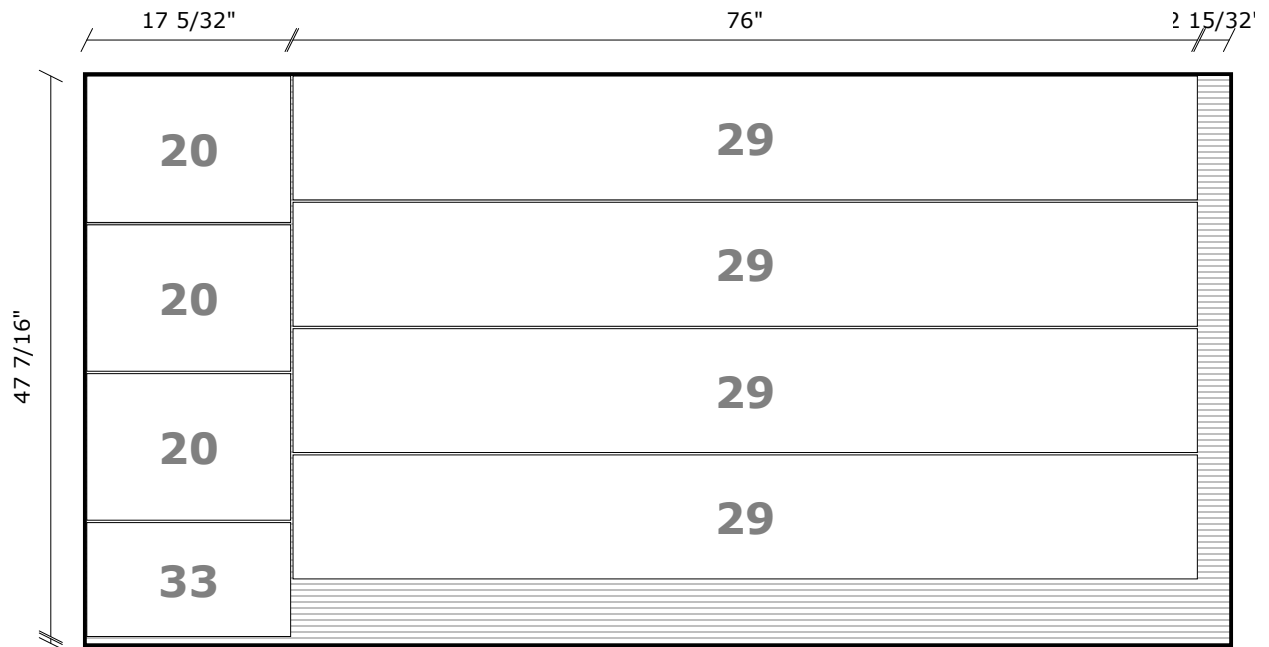

[B2] Birch: 3/4" x 96" x 48"

Vendor: Bin:

<input type="checkbox"/> 2 of 3 this size	Qty this diag.: 1	Grain: Horizontal	Stock Trim: 0"::0"	Standard Layout
Kerf: 3/16"	Part Padding: 0"	Waste: 13.3%	Final Cut Dimensions	

Part #	Sub-Assembly	Description	Copies in Layout	Thick	Final Cut Y	Final Cut X	Rough Y	Rough X	Banding	<Info>
20	Bench Carcass	Shelves	3	3/4"	12 13/32"	17 5/32"	12 13/32"	17 5/32"	None	
29	Top Carcass	Sides	4	3/4"	10 1/2"	76"	10 1/2"	76"	None	
33	Top Carcass	Shelves	1	3/4"	9 21/32"	17 5/32"	9 21/32"	17 5/32"	None	

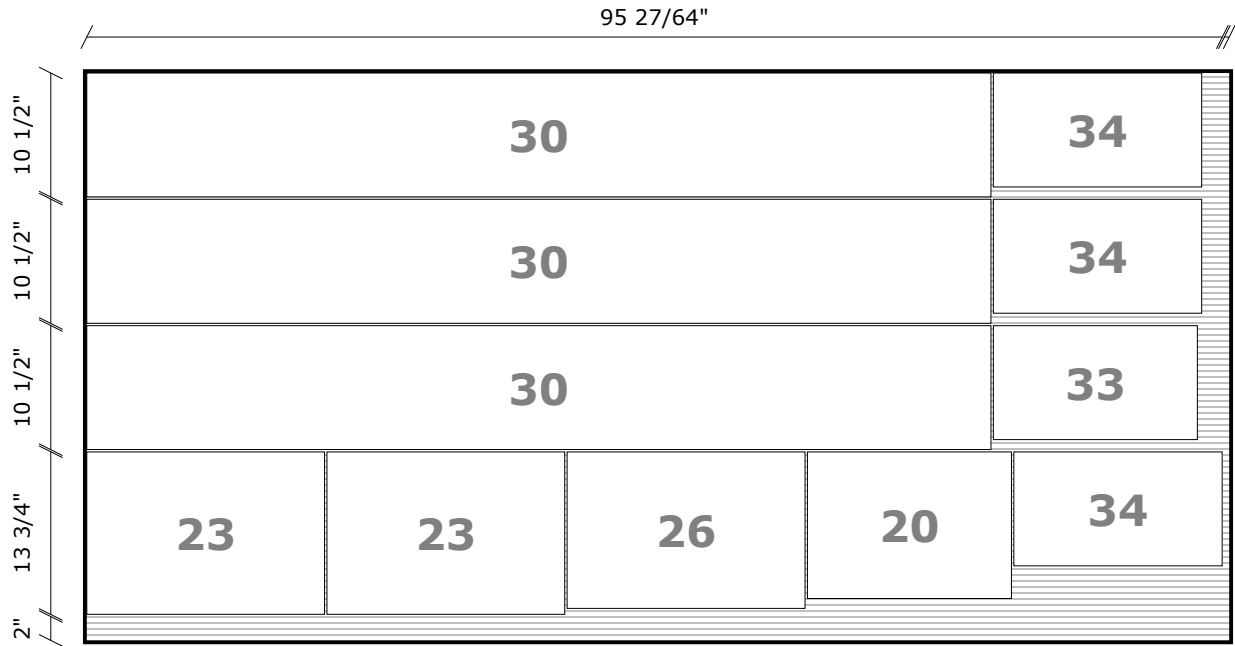

[B3] Birch: 3/4" x 96" x 48"

Vendor: Bin:

[] 3 of 3 this size Qty this diag.: 1 Grain: Horizontal Stock Trim: 0"::0" Standard Layout

Kerf: 3/16" Part Padding: 0" Waste: 11.1% Final Cut Dimensions

Part #	Sub-Assembly	Description	Copies in Layout	Thick	Final Cut Y	Final Cut X	Rough Y	Rough X	Banding	<Info>
20	Bench Carcass	Shelves	1	3/4"	12 13/32"	17 5/32"	12 13/32"	17 5/32"	None	
23	Bench Carcass	Sides	2	3/4"	13 3/4"	20"	13 3/4"	20"	None	
26	Bench Carcass	Veritcal Divider	1	3/4"	13 1/4"	20"	13 1/4"	20"	None	
30	Top Carcass	Vertical Divider	3	3/4"	10 1/2"	76"	10 1/2"	76"	None	
33	Top Carcass	Shelves	1	3/4"	9 21/32"	17 5/32"	9 21/32"	17 5/32"	None	
34	Top Carcass	Middle Shelves	3	3/4"	9 21/32"	17 33/64"	9 21/32"	17 33/64"	None	

Bill of Materials

Cost Summary

Item	Amount
Rough Lumber	\$182.90
Dimensioned Lumber	\$0.00
Sheet Goods	\$624.00
Edge Banding	\$0.00
Other Items	\$0.00
Labor Costs (0.0 hours)	\$0.00
Project Total	\$806.90

Rough Lumber

[x]	Material Name	Nominal Size	Unit Cost	Units	Yield	Quantity	From Inv.	To Buy	Total Cost	Vendor	Bin
[]	Oak, Red	5/4	\$2.20	Bd Ft	60%	22.72	22.72	0.00	\$49.99		
[]	Poplar	4/4	\$1.95	Bd Ft	60%	67.35	67.35	0.00	\$131.33		
[]	Poplar	5/4	\$2.20	Bd Ft	60%	0.72	0.72	0.00	\$1.58		

Sheet Goods

[x]	Material Name	Thick	Width	Length	Unit Cost	Units	Quantity	From Inv.	To Buy	Total Cost	Vendor	Bin
[]	Birch	1/2"	48"	96"	\$74.55	Sheets	4	4	0	\$298.20		
[]	Birch	3/4"	48"	96"	\$108.60	Sheets	3	3	0	\$325.80		