

# three drawer dresser

By **Jaime Costiglio**

Difficulty

Moderate

A three drawer dresser with three open cubby shelves. Intended as a large nightstand between to bed for a shared bedroom but can be used as a stand along dresser or behind a sofa, etc.





# Tools

## Kreg Tools

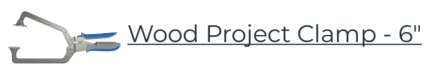

## Other Tools

Circular Saw (corded)

Jigsaw

Miter Saw

Square

Tape Measure

Drill (cordless)

Impact Driver

Nail Gun

Sander

# Materials

## Wood Products

**2** Plywood , 3/4" Thick , Full Sheet

**5** Board , 1x5 , 72"

**2** Board , 1x6 , 96"

**1** Board , 1x8 , 72"

**1** Plywood , 1/4" Thick , Full Sheet

## Hardware & Supplies

**1** Box 1 1/4" Kreg Pocket Hole Screws

**6** 2" Wood Screws

**36** 1 1/4" Wood Screws

**1** Sleeve 2" Finish Nails

**1** Sleeve 3/4" Finish Nails

**3** 21" Drawer Glides

# Cut List & Parts

- 5** Top , 1x5 @ 66"
- 1** Cubby Shelf , 3/4" X 22 1/2" X 64 1/2"
- 2** Sides , 3/4" X 22 1/2" X 27 1/4"
- 5** Dividers & Drawer Support , 3/4" X 22 1/2" X 21"
- 2** Cubby Dividers , 3/4" X 22 1/2" X 5 1/2"
- 1** Backing , 1/4" X 66" X 14 1/2"
- 3** Drawer Fronts , 1x8 @ 20 3/4"
- 6** Drawer Sides , 1x6 @ 21 3/4"
- 6** Drawer Fronts & Backs , 1x6 @ 18 1/4"
- 3** Drawer Base , 1/4"x 21 3/4" X 19 3/4"

# Directions

**1**

## Dimensions

Overall dimensions 66"w x 22 1/2"d x 28"h

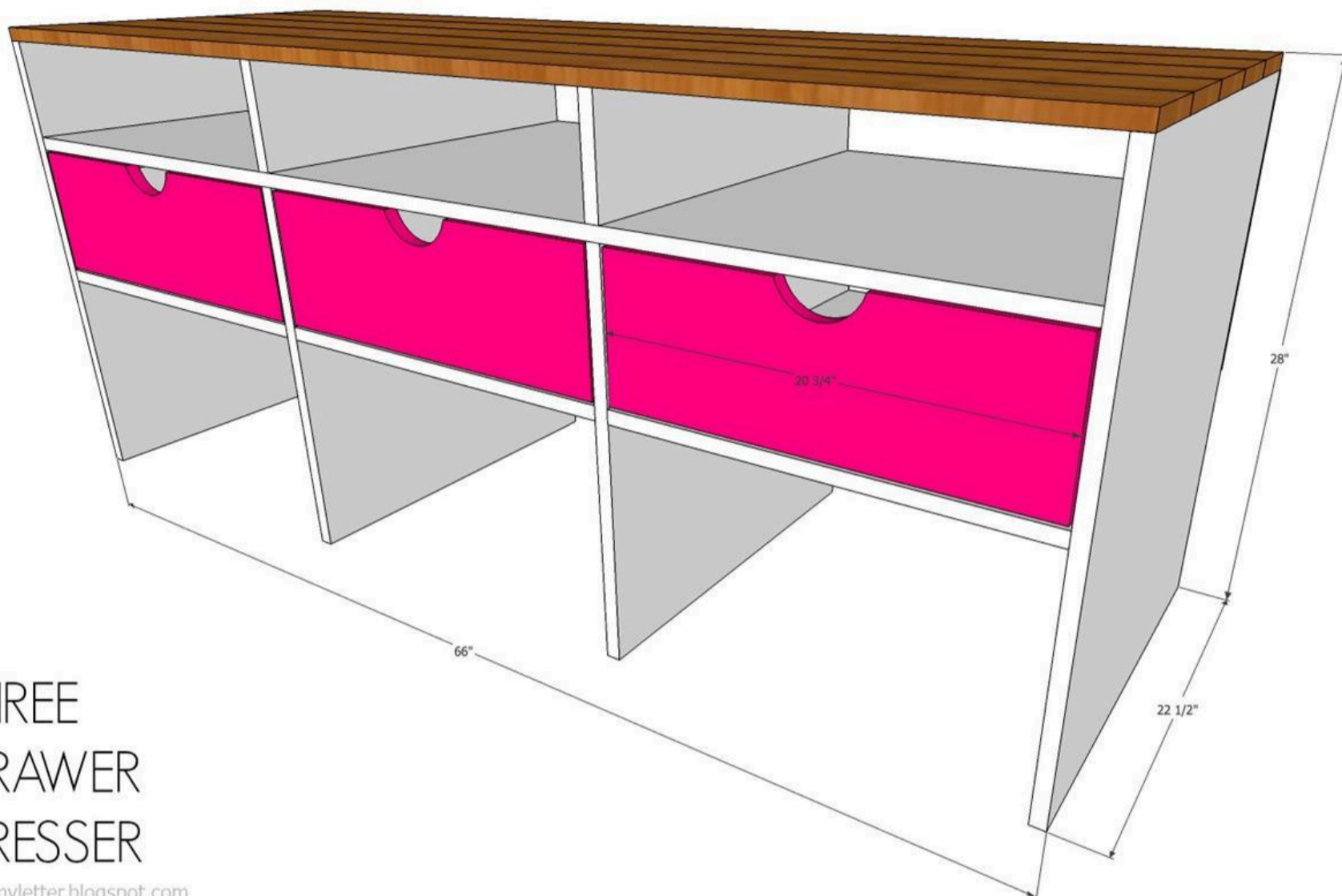

THREE  
DRAWER  
DRESSER

[thatsmyletter.blogspot.com](http://thatsmyletter.blogspot.com)

**2**

## Step 1: top

Attach the top boards using wood glue, pocket holes and 1 1/4" pocket hole screws. Keep boards flush to form one smooth surface. Once all boards are attached measure the width to confirm 22 1/2" before cutting plywood sheets for remaining steps as 1x5 boards can vary in width.

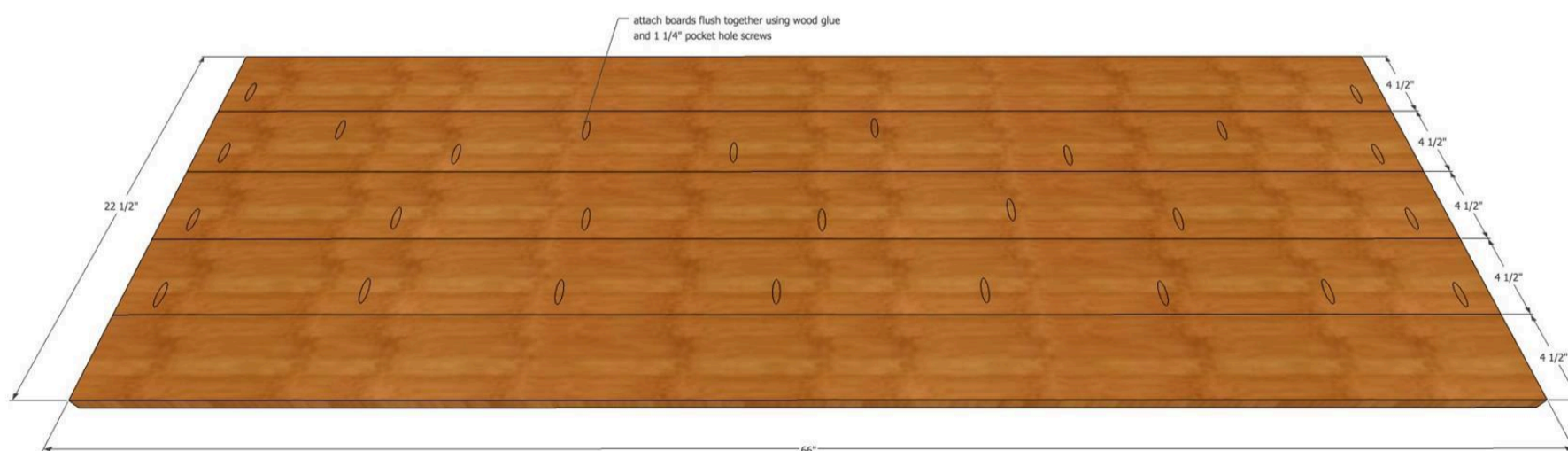

THREE DRAWER DRESSER  
STEP 1: TOP

[thatsmyletter.blogspot.com](http://thatsmyletter.blogspot.com)

3

### Step 2: sides

Attach sides to underside of top using wood glue, pocket holes and 1 1/4" pocket hole screws.

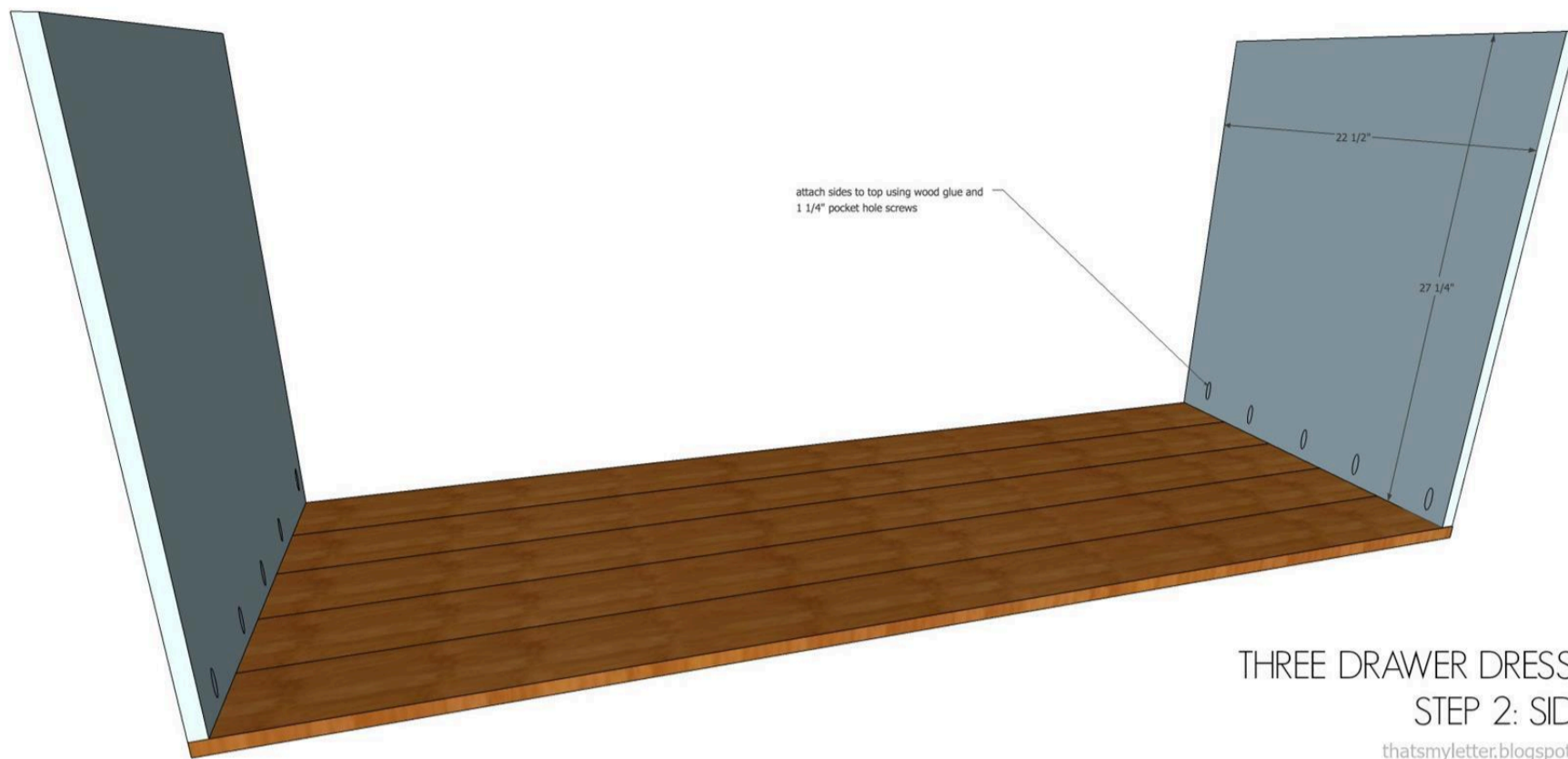

THREE DRAWER DRESSER  
STEP 2: SIDES

[thatsmyletter.blogspot.com](http://thatsmyletter.blogspot.com)

4

### Step 3: cubby shelf

Attach cubby shelf to sides using wood glue, pocket holes and 1 1/4" pocket hole screws.



THREE DRAWER DRESSER  
STEP 3

[thatsmyletter.blogspot.com](http://thatsmyletter.blogspot.com)

5

### Step 4: cubby dividers

Attach cubby dividers using countersunk 2" wood screws from underneath and 2" finish nails from the top.

## THREE DRAWER DRESSER STEP 4

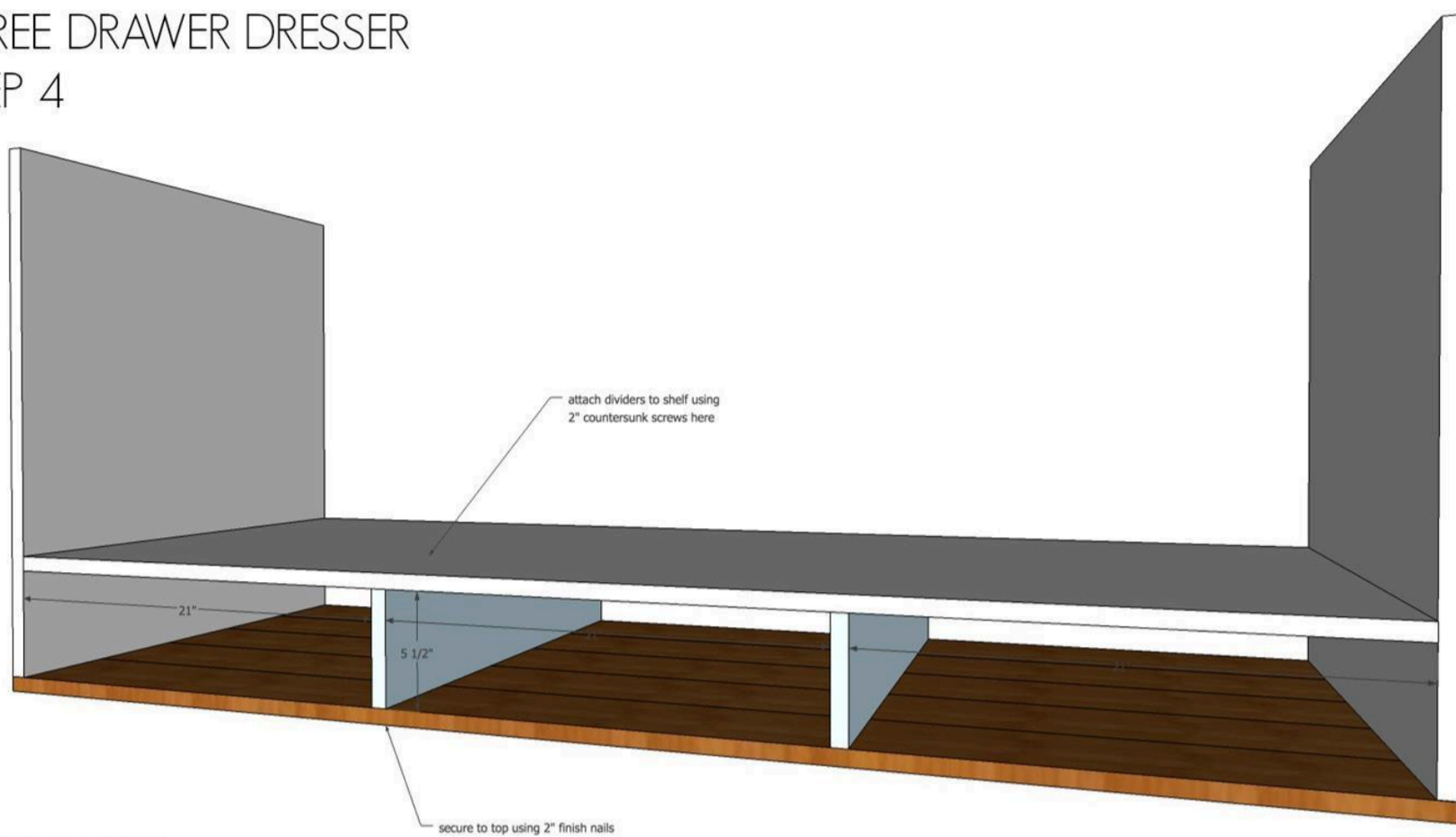

6

### Step 5: drawer dividers

Attach drawer dividers to shelf using wood glue, pocket holes and 1 1/4" pocket hole screws.

## THREE DRAWER DRESSER STEP 5

thatsmyletter.blogspot.com

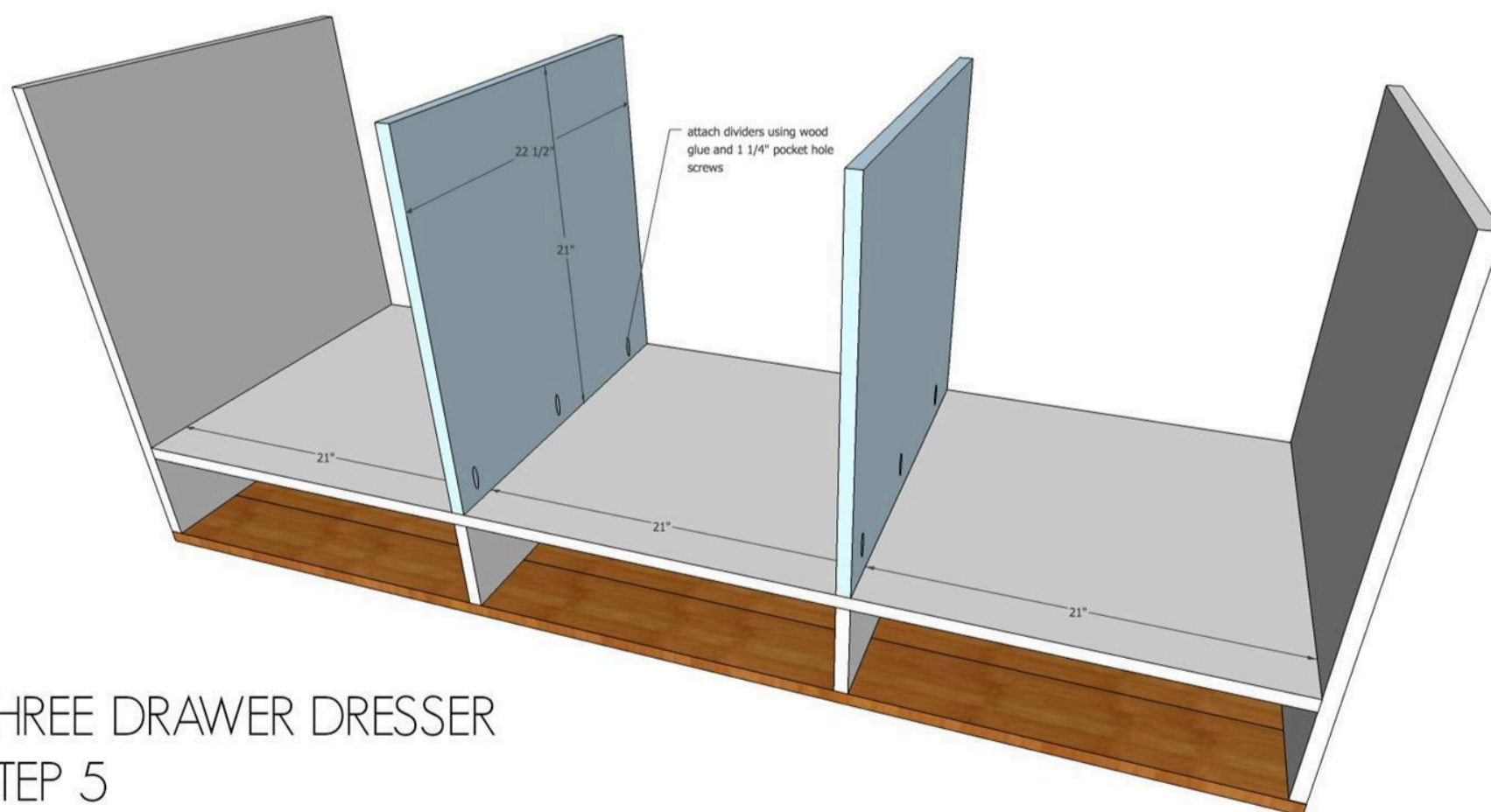

7

### Step 6: drawer supports

Attach drawer supports using wood glue, pocket holes and 1 1/4" pocket hole screws.

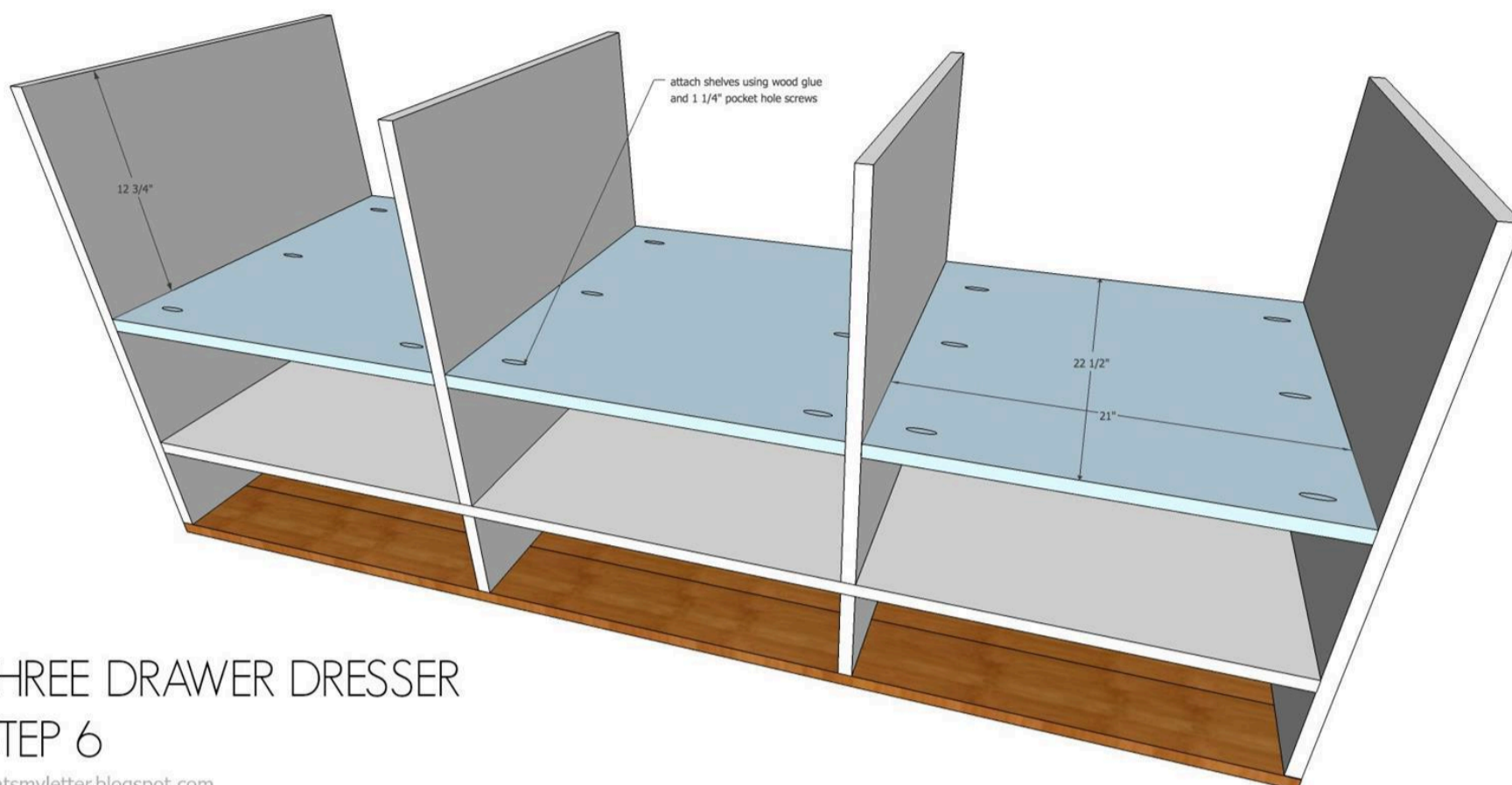

## THREE DRAWER DRESSER STEP 6

[thatsmyletter.blogspot.com](http://thatsmyletter.blogspot.com)

8

### Step 7: drawer box

Construct drawer box using wood glue, pocket holes and 1 1/4" pocket hole screws.

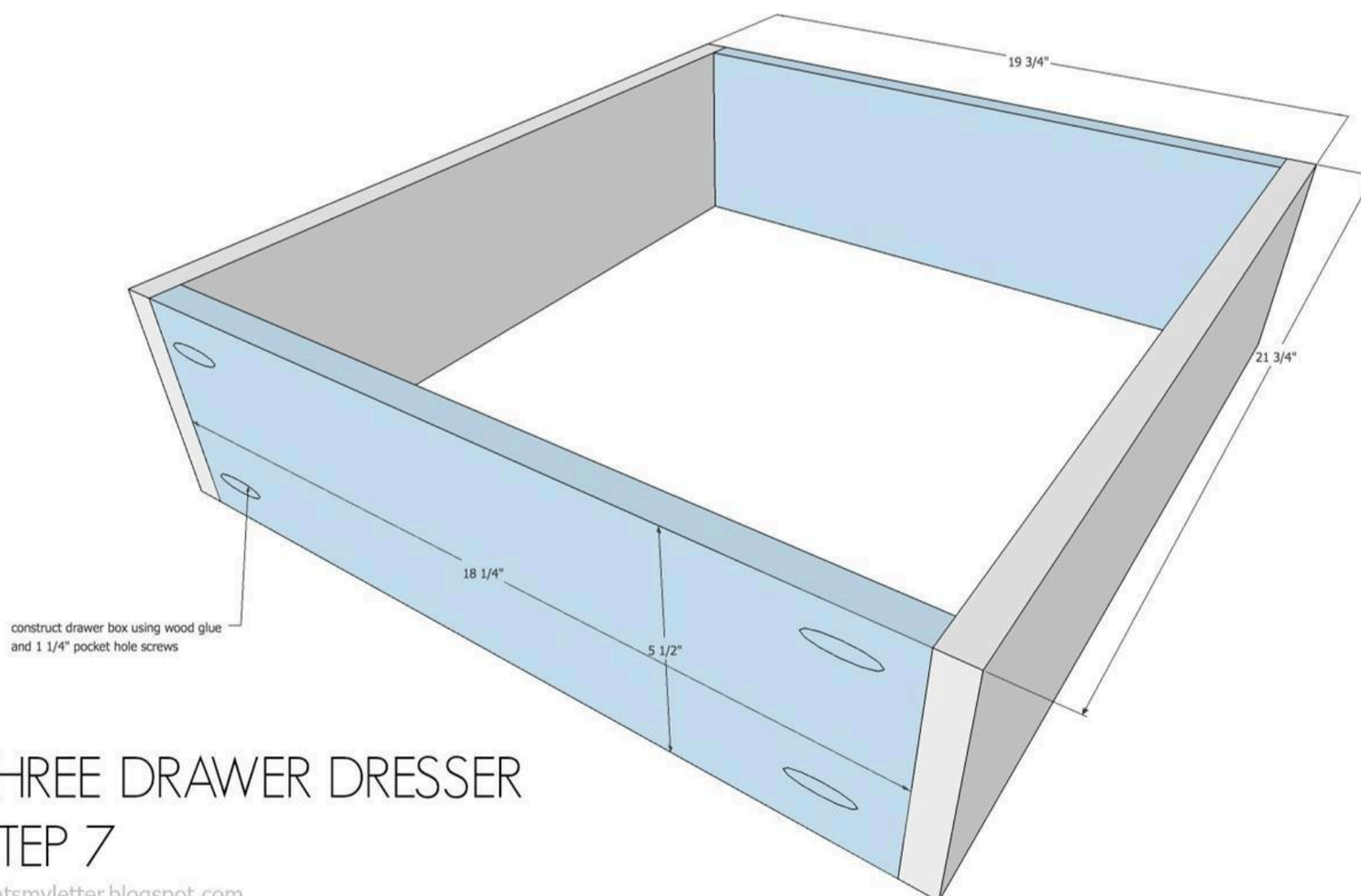

## THREE DRAWER DRESSER STEP 7

[thatsmyletter.blogspot.com](http://thatsmyletter.blogspot.com)



9

### Step 8: drawer base

Attach base to drawer using wood glue and countersunk 1 1/4" screws.

attach bottom using wood glue and countersunk 1 1/4" screws

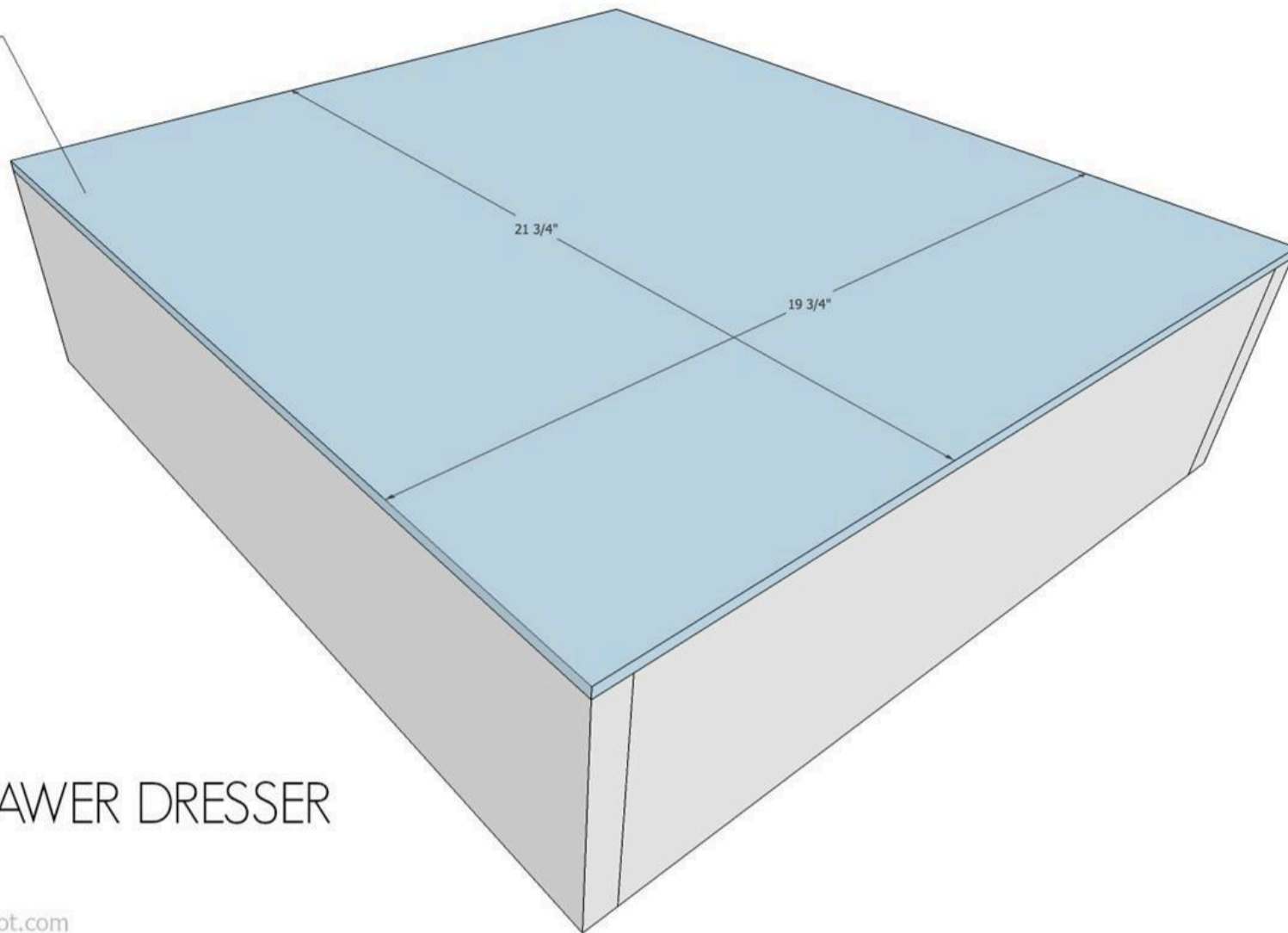

## THREE DRAWER DRESSER STEP 8

[thatsmyletter.blogspot.com](http://thatsmyletter.blogspot.com)

10

### Step 9: drawer front

Cut out drawer front handle pull as per sketch.

## THREE DRAWER DRESSER STEP 9

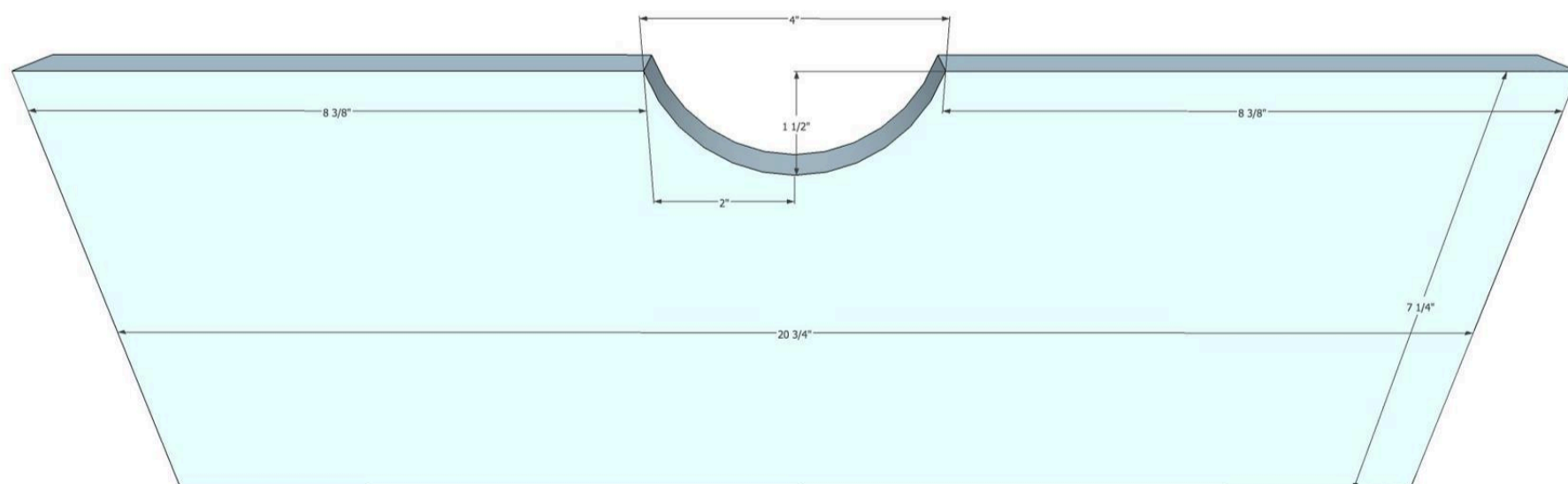

[thatsmyletter.blogspot.com](http://thatsmyletter.blogspot.com)

11

### Step 10: drawer front

Attach drawer glides as per hardware instructions. Put drawer front in place with wood glue and finish nails then remove drawer and secure front to box using countersunk 1 1/4" wood screws from interior.

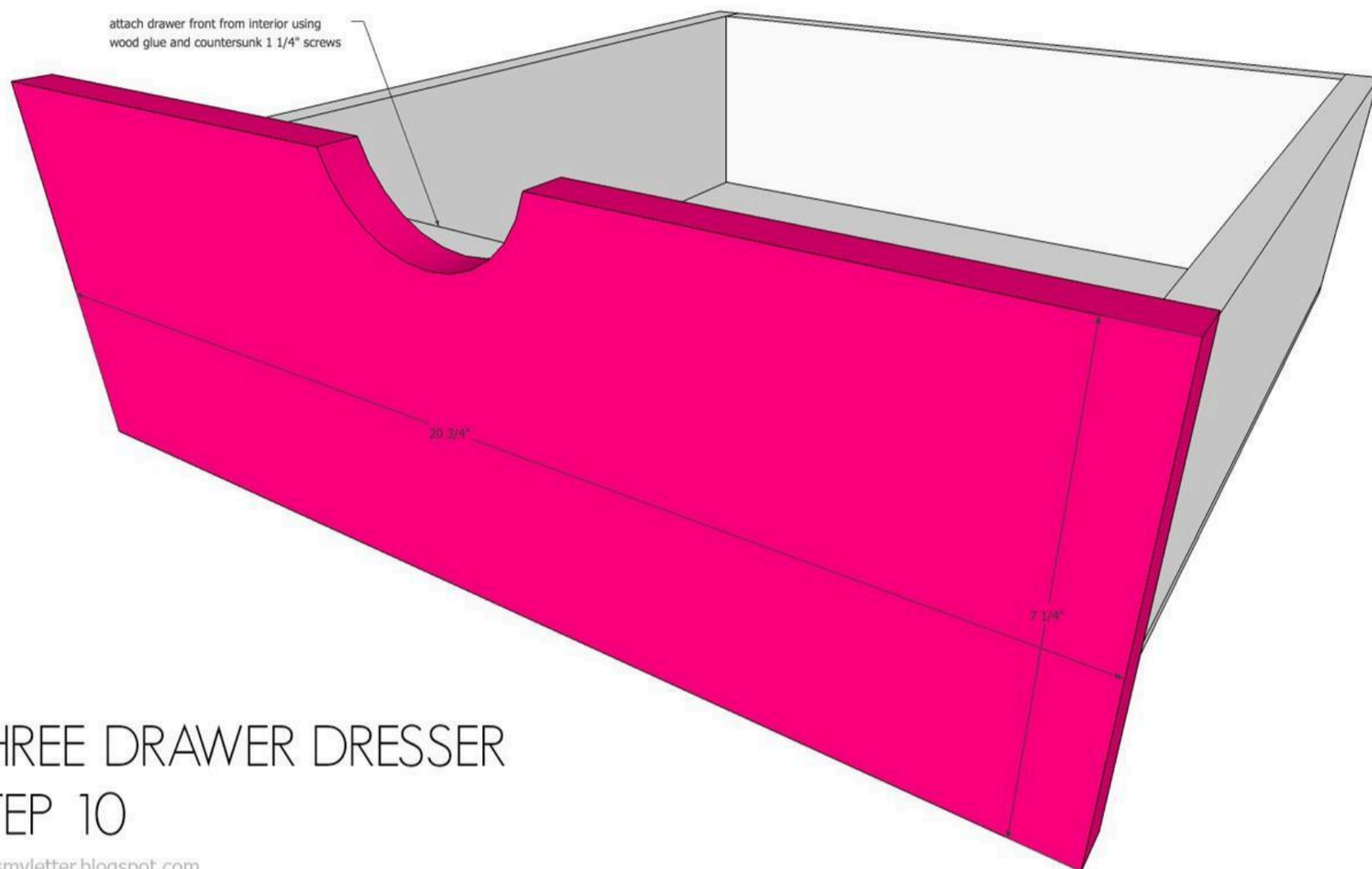

## THREE DRAWER DRESSER STEP 10

[thatsmyletter.blogspot.com](http://thatsmyletter.blogspot.com)

12

**Step 11: backing**

Attach backing to unit using wood glue and 3/4" finish nails.

