

Potting Bench with Hidden Garbage Enclosure

By **Reality Daydream**

Difficulty
Moderate

Learn how to build the mother of all potting benches! This hefty potting bench has shelving for storage, two garbage/trash can enclosures hidden behind doors, tons of work surface, slats for hanging tools, and a roof!

See more pics and details on our blog!

<http://realitydaydream.com/potting-bench-with-hi>

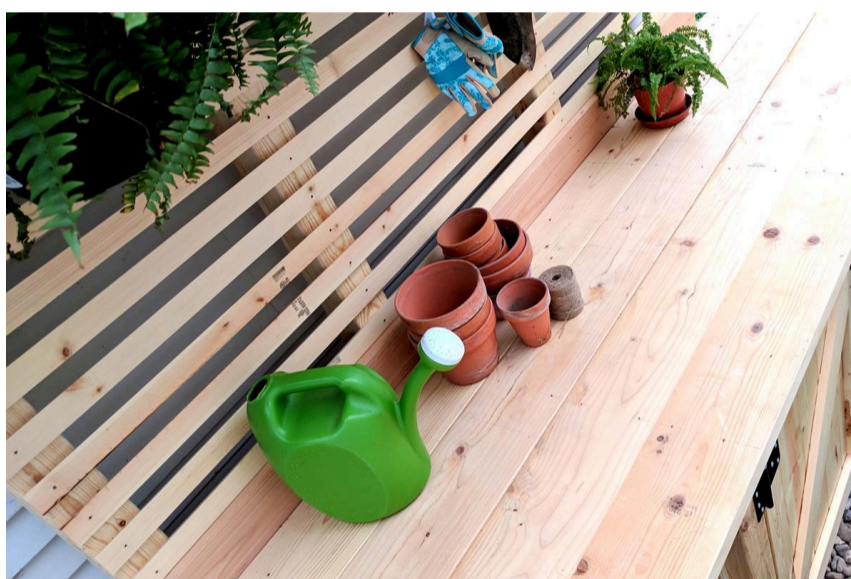





Tools

Kreg Tools

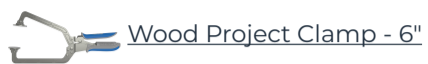

Other Tools

Miter Saw

Square

Table Saw

Tape Measure

Drill (cordless)

Impact Driver

Nail Gun

Router Table

Workbench

Materials

Wood Products

11 Board , 2x4 , 96"

1 Board , 2x6 , 96"

4 Board , 2x8 , 96"

8 Board , 4x4 , 96"

1 Plywood , 5/8 Thick , Full Sheet

12 Board , 1x6 , 72"

8 Board , 1x8 , 72"

10 Board , 1x4 , 72"

5 Board , 1x6 , 96"

1 Plywood , 1/2" Thick , Full Sheet

Hardware & Supplies

250 2 1/2 Inch Outdoor Kreg Screws

250 1 1/4 Inch Kreg Screws

4 Hinge

2 Handle

2 Latch

1 Outdoor Wood Glue

100 T10 2" FINISHING SCREWS

Cut List & Parts

- 4 LEG, FRONTS , 4 X 4 X 34 1/2
- 8 LEG, TOP AND BOTTOM , 4 X 4 24 3/4
- 4 LEG, BACK , 4 X 4 X 96
- 4 LEG ASSEMBLY , N/A
- 2 LEG DIVIDER, SMALL , 2 X 4 X 19
- 2 LEG BRACE , 2 X 4 X 36 7/16
- 4 LEG DIVIDER, LARGE , 2 X 4 X 25 1/2
- 1 POTTING BENCH, LEG ASSY , N/A
- 1 BACK SPLASH , 2 X 6 X 84
- 4 BENCH TOP BOARD , 2 X 8 X 90
- 1 BENCH TOP ASSEMBLY , N/A
- 7 ROOF TRUSS , 2 X 4 X 34
- 7 ROOF TRUSS, BRACE , 2 X 4 X 24 3/4
- 3 ROOF TRUSS BRACE, BACK AND BOTTOM , 2 X 4 X 87
- 1 ROOF TRUSS, BRACE, FRONT , 1 X 4 X 87
- 1 ROOF PLYWOOD , 5/8 X 35 3/16 X 87
- 1 ROOF ASSEMBLY , N/A
- 12 SIDE BOARDS , 1 X 5 1/4 X 33
- 2 SIDE TRIM, BACK , 1 X 3 X 33
- 4 SIDE TRIM, TOP AND BOTTOM , 1 X 3 X 26 1/2
- 2 SIDE TRIM, FRONT , 1 X 2 1/4 X 33
- 2 SIDE ASSEMBLY , N/A
- 10 DOOR BOARD , 1 X 5 X 32 3/4
- 4 DOOR TRIM, SIDE , 1 X 3 X 32 3/4
- 2 DOOR TRIM, BRACE , 1 X 3 X 32 11/16
- 4 DOOR TRIM, TOP AND BOTTOM , 1 X 3 X 19
- 2 DOOR ASSEMBLY , N/A
- 4 SHELF SIDE , 1 X 2 X 28 1/4
- 4 SHELF BACK/DIVIDER , 1 X 2 X 16 1/2
- 2 SHELF, FRONT , 1 X 2 X 18
- 16 SHELF, SLAT , 1 X 1 3/4 X 29
- 2 SHELF ASSEMBLY , N/A
- 2 PLYWOOD SHEET FOR SHELF SIDE , 1/2 X 29 X 33
- 1 PLYWOOD SHEET FOR SHELF BACK , 1/2 X 19 X 33
- 2 TRIM FRONT , 1 X 3 X 33
- 2 TRIM FOR SHELF , 5/8 X 5/8 X 33
- 2 TRIM FOR BENCH TOP , 1 1/2 X 1 1/2 X 5
- 14 BACK WALL SLATS , 1 X 1 5/8 X 84

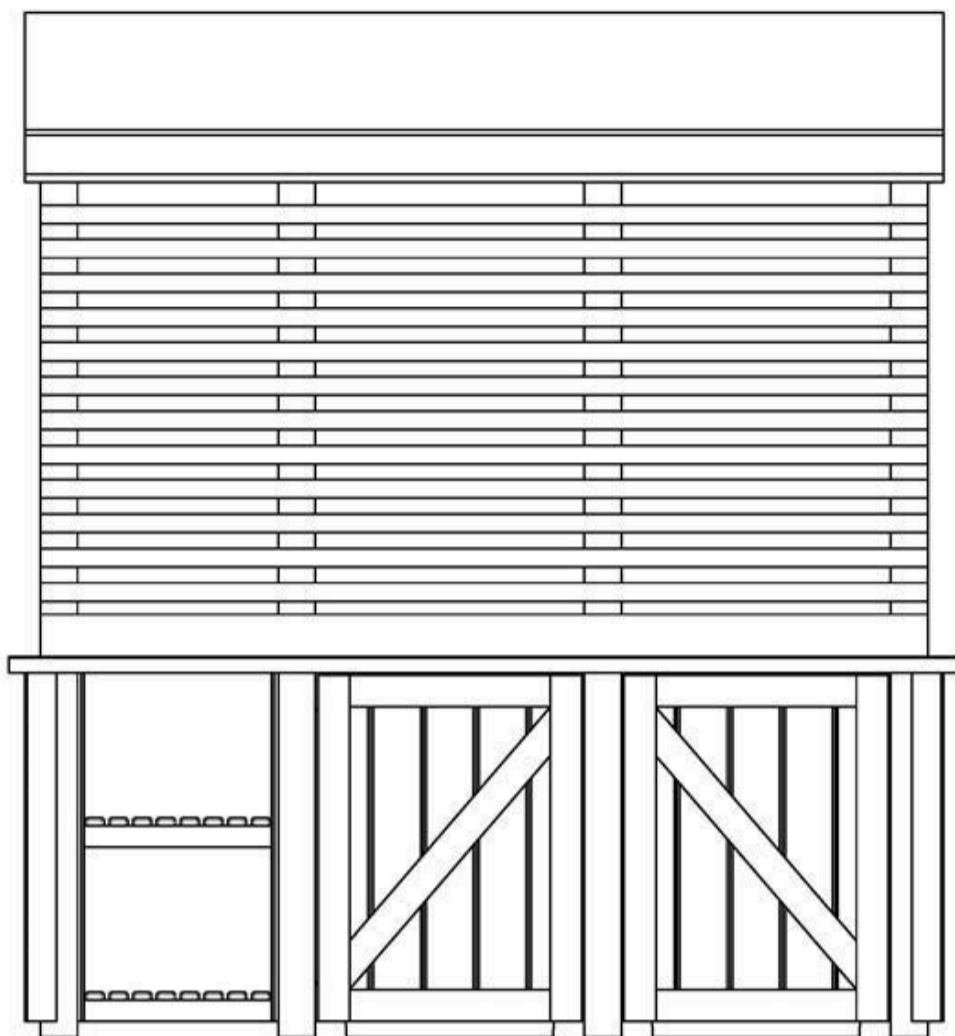

POTTING BENCH
FRONT VIEW

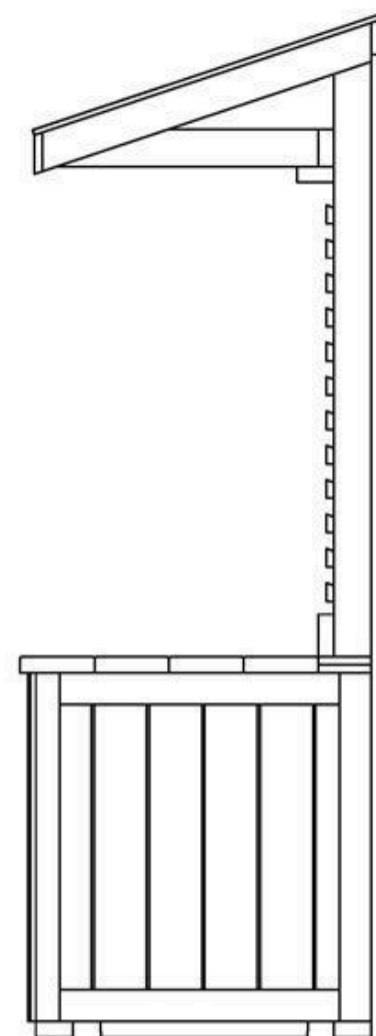

POTTING BENCH
SIDE VIEW



So much more awesome DIY at
www.RealityDaydream.com



LEG, FRONT
4X4 QTY 4

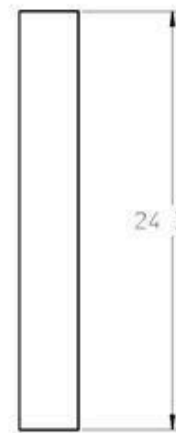
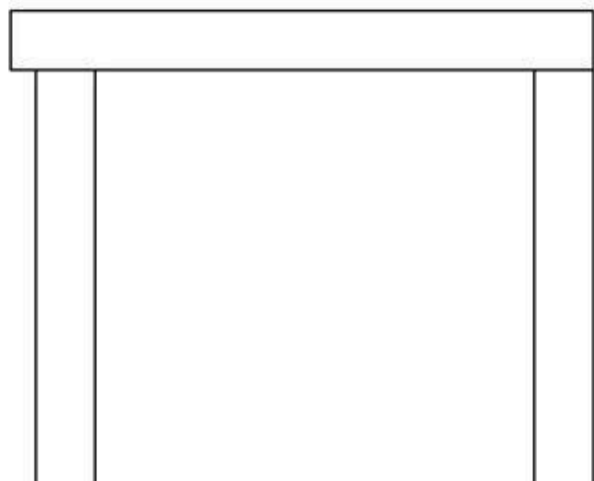

LEG, TOP AND BOTTOM
4X4 QTY 8



LEG
4X4 QTY 4

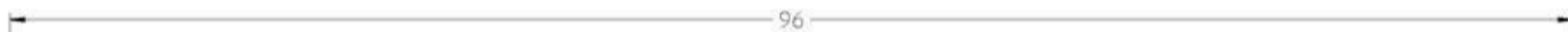

LEG, BACK
4X4 QTY 4



So much more awesome DIY at
www.RealityDaydream.com

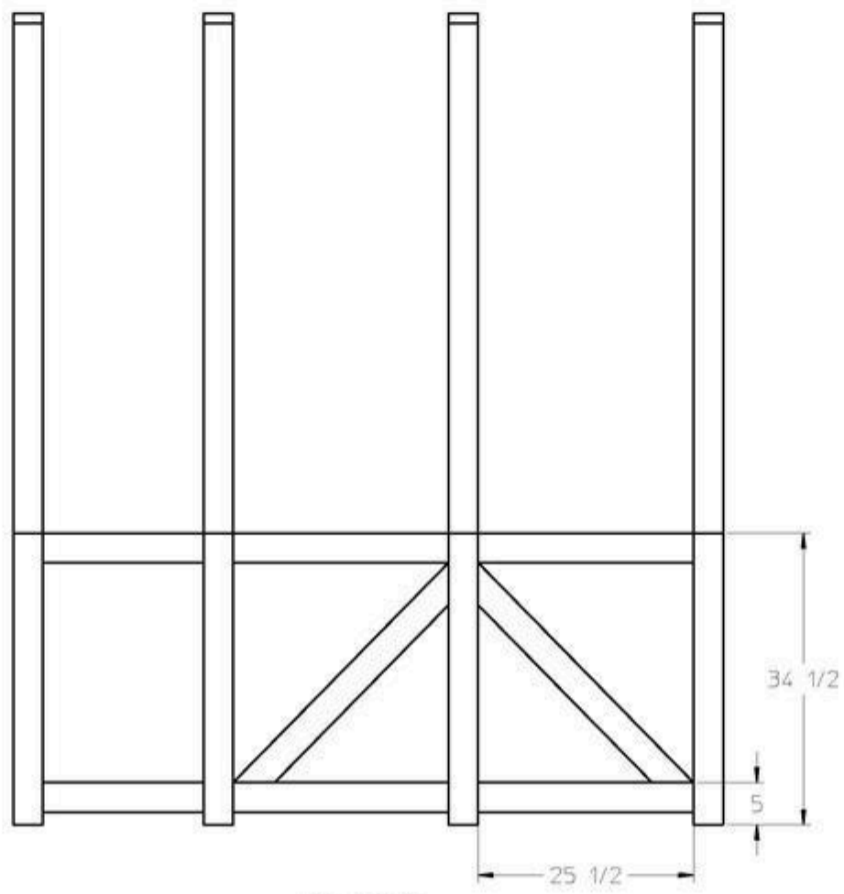

LEG ASSY
FRONT VIEW

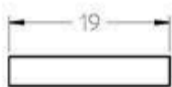
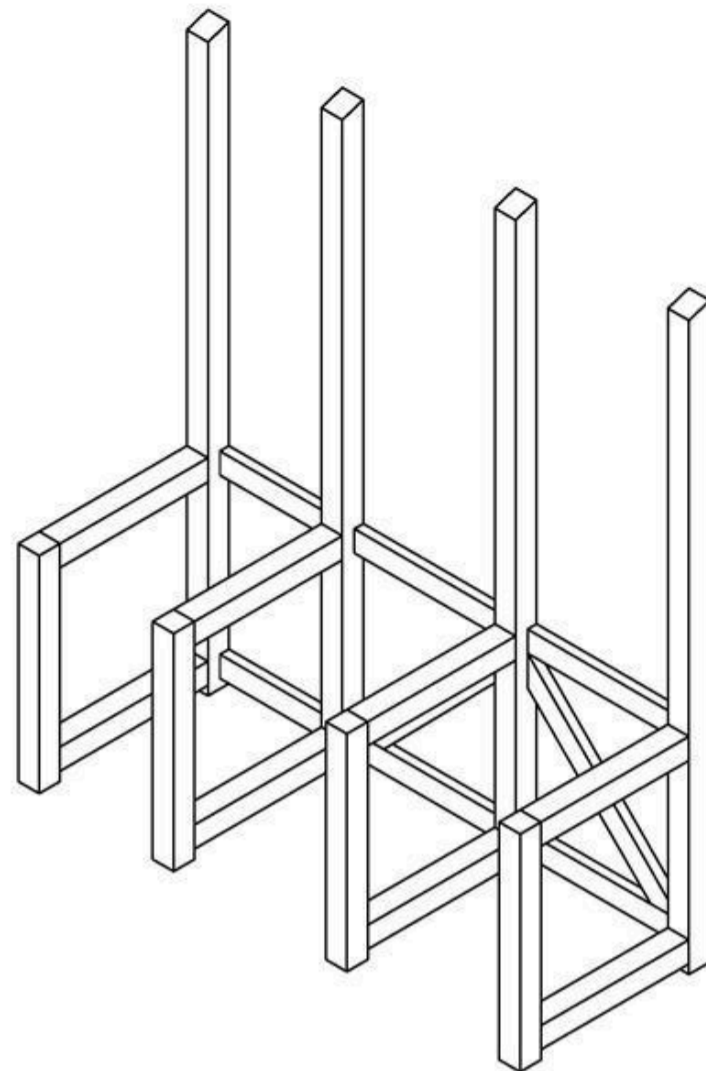

LEG DIVIDER, SMALL
2X4 QTY 2

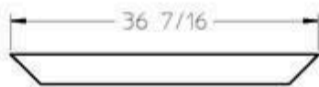

LEG BRACE
2X4 QTY 2

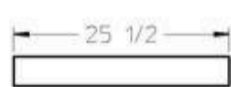

LEG DIVIDER, LARGE
2X4 QTY 4



So much more awesome DIY at
www.RealityDaydream.com

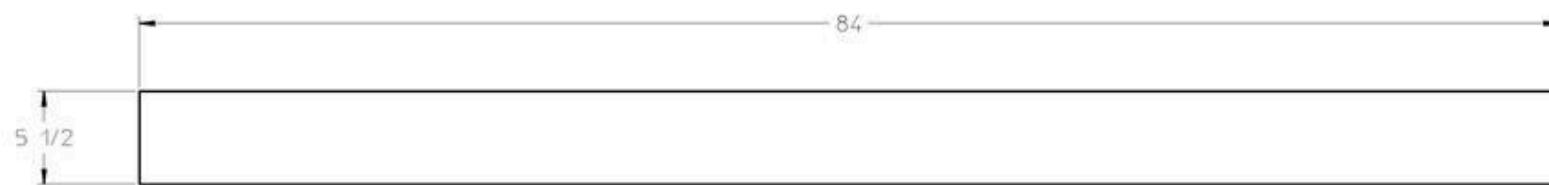

BACK SPLASH
2X6 QTY 1

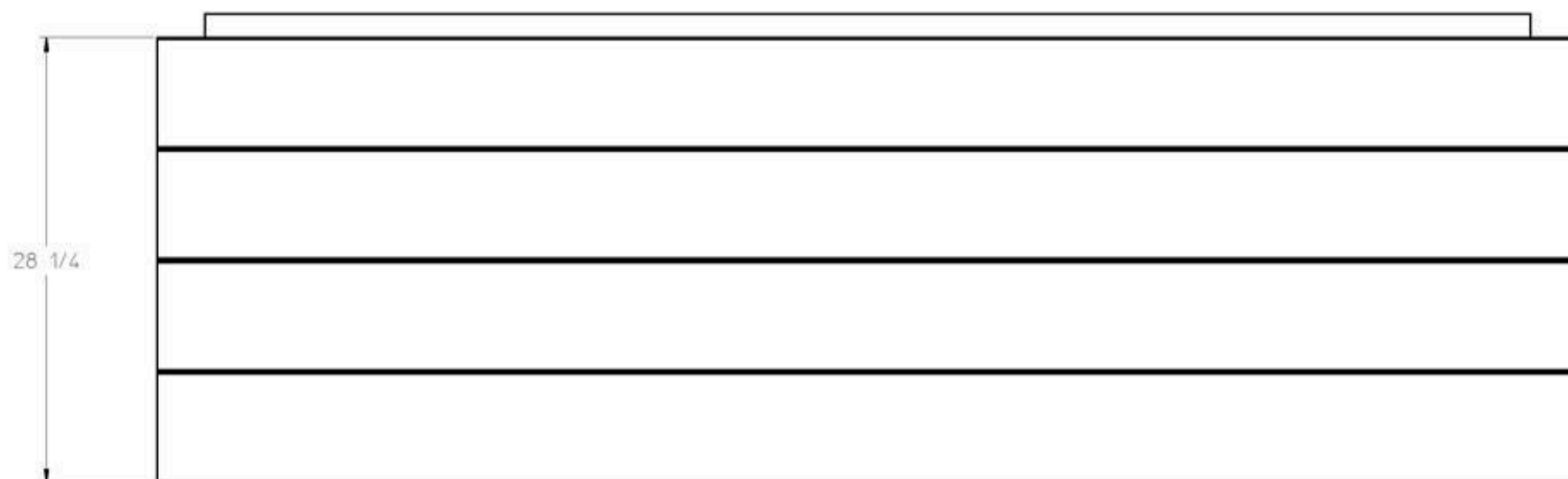

BENCH TOP ASSEMBLY



BENCH TOP BOARD
2X8 QTY 4



So much more awesome DIY at
www.RealityDaydream.com

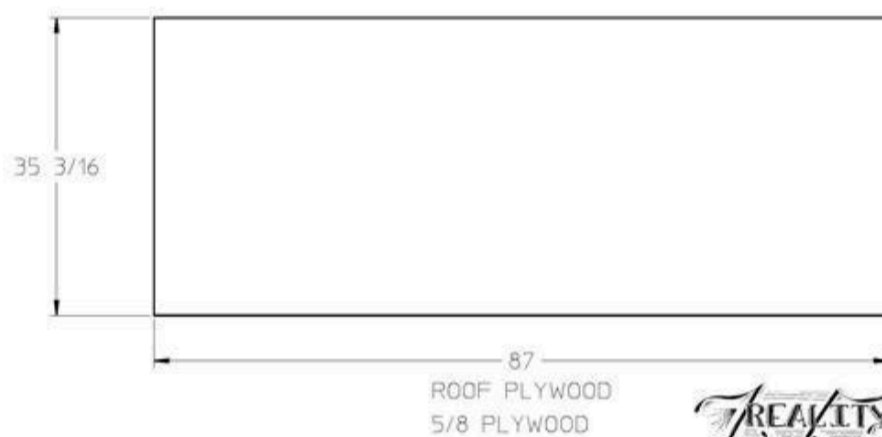
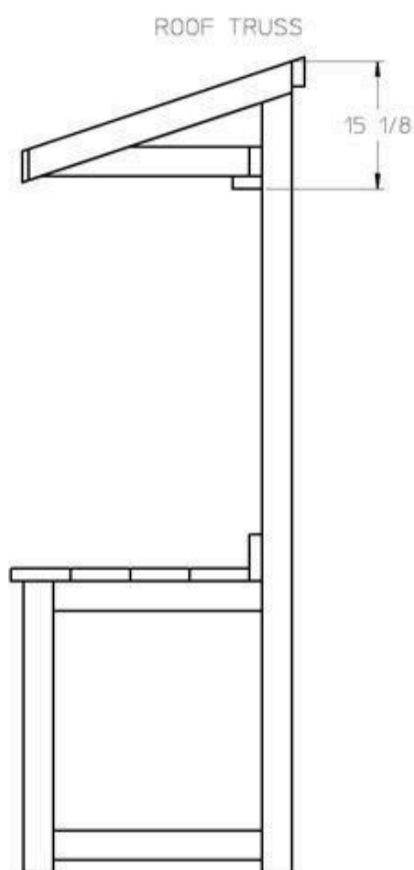
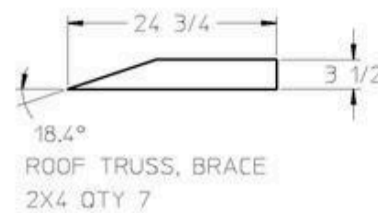
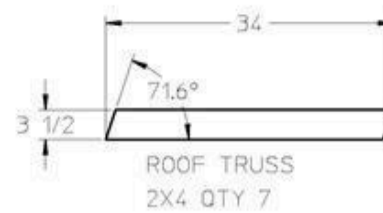
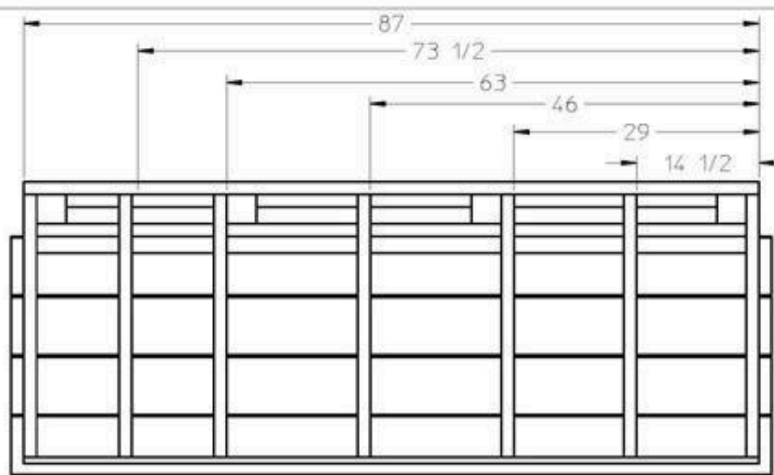

So much more awesome DIY at
www.RealityDaydream.com

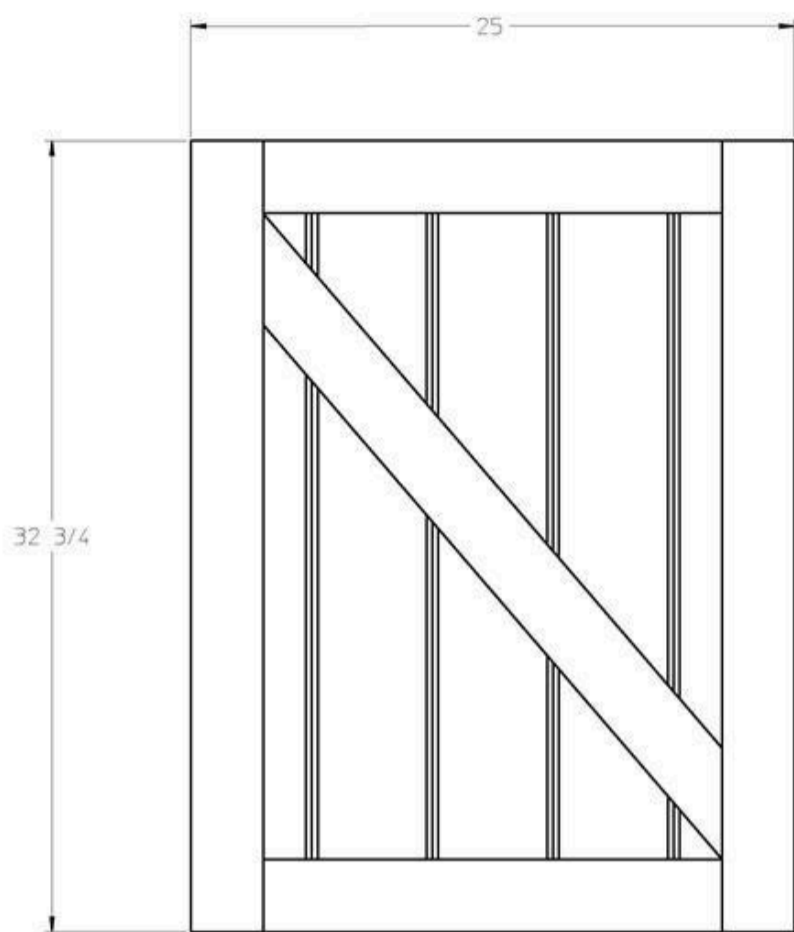

DOOR ASSEMBLY
QTY 2



DOOR BOARD
1X6 QTY 5
PER DOOR)

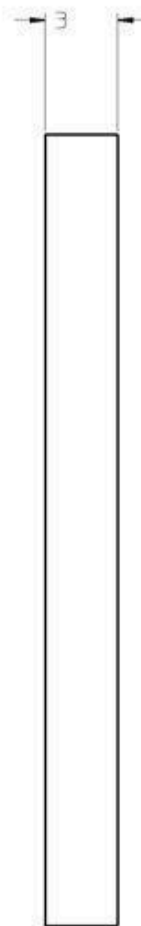

DOOR TRIM, SIDE
1X4 QTY 2
PER DOOR)



DOOR TRIM, BRACE
1X4 QTY 1(PER DOOR)



DOOR TRIM, TOP/BOTTOM
1X4 QTY 2(PER DOOR)



So much more awesome DIY at
www.RealityDaydream.com

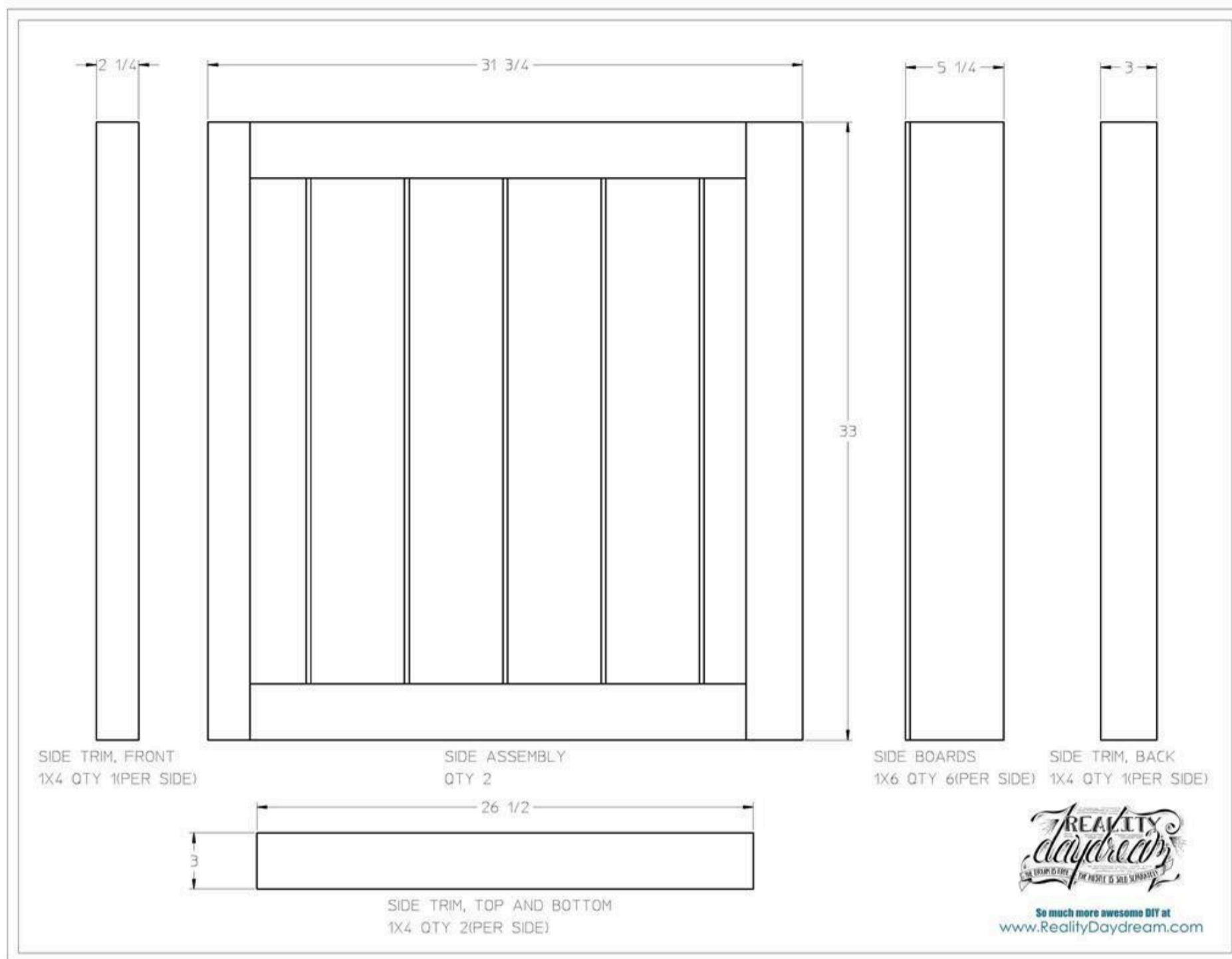

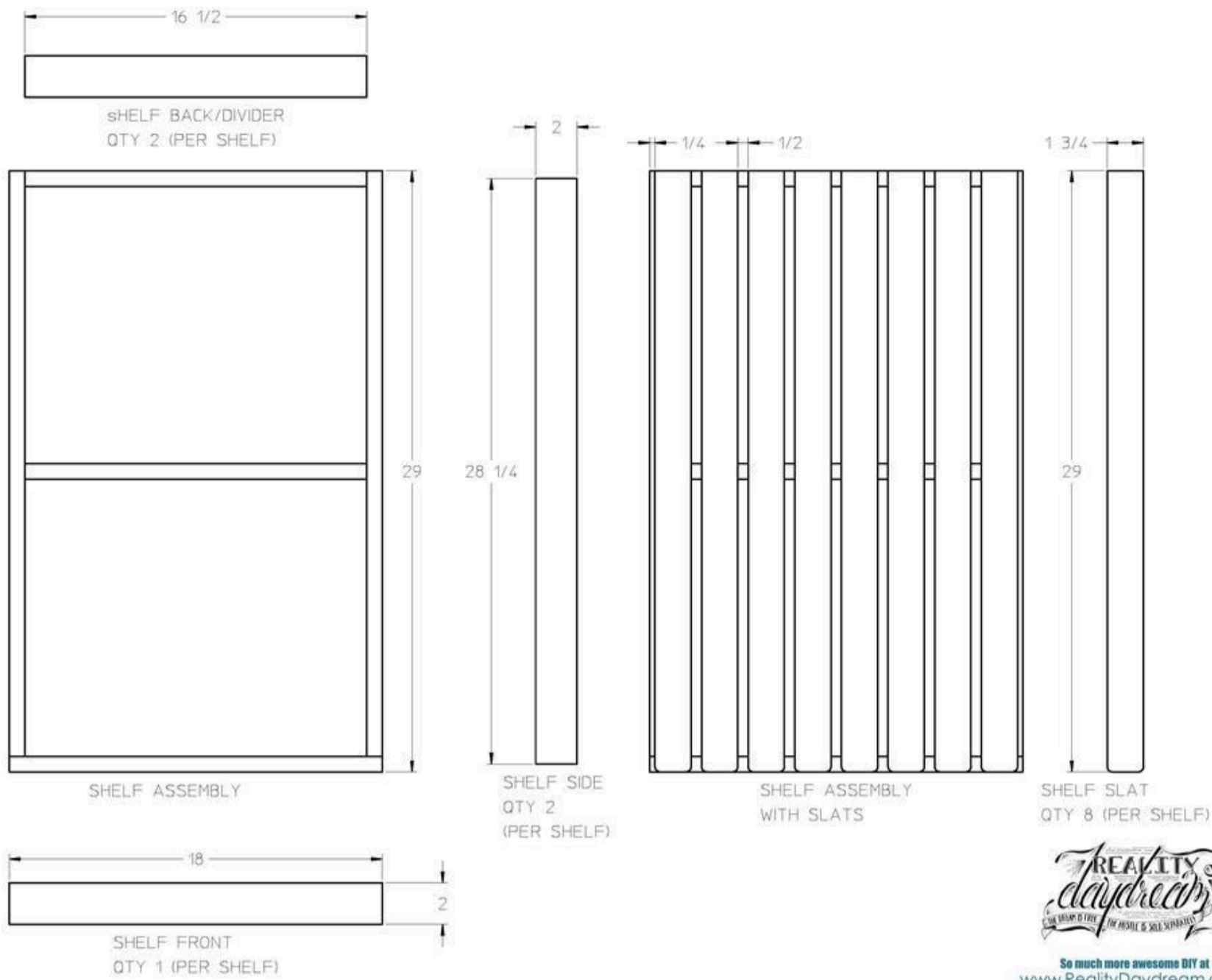

So much more awesome DIY at
www.RealityDaydream.com

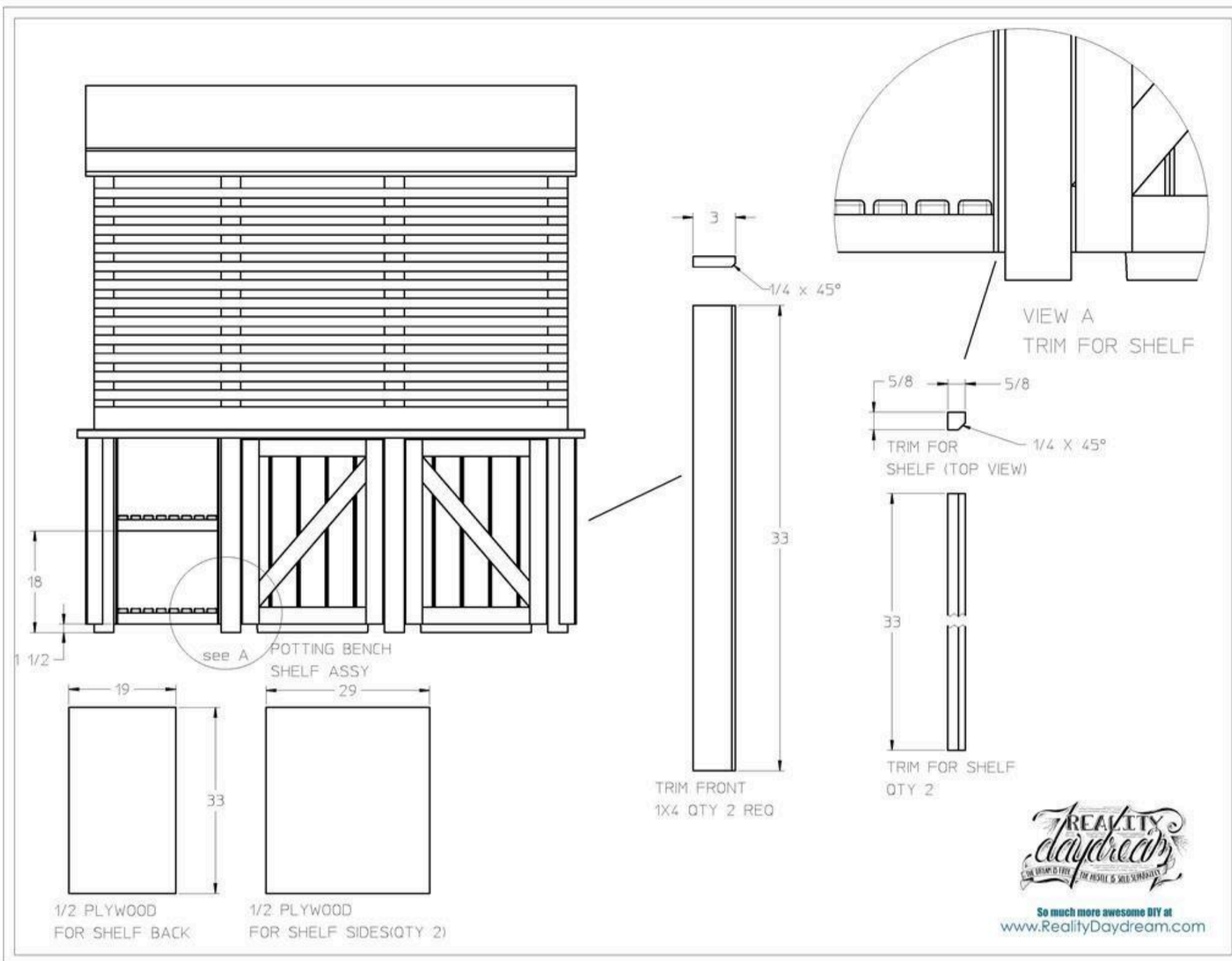

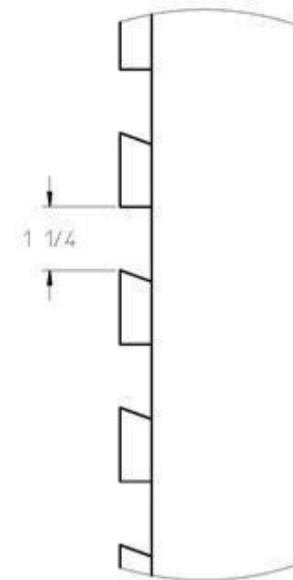
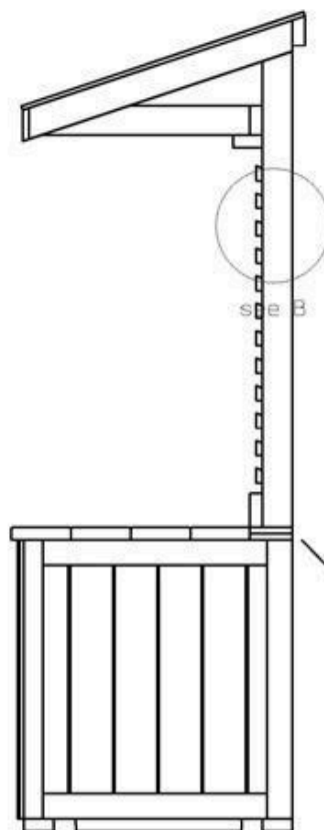
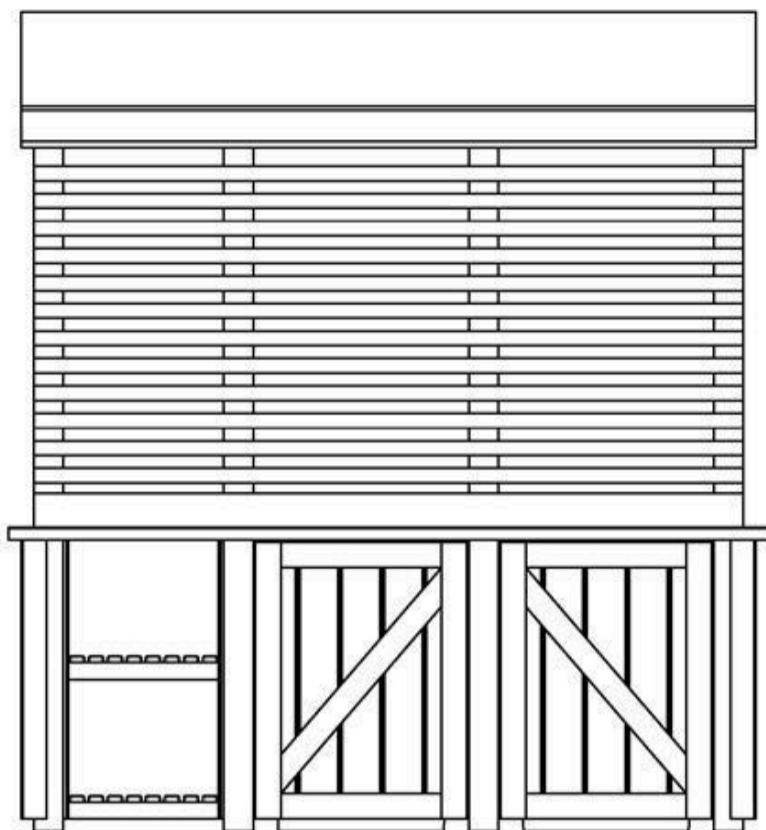

VIEW B
SLAT SPACING

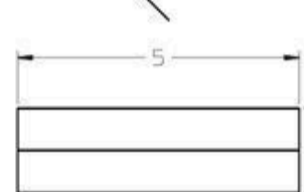

BENCH TOP TRIM
QTY 2

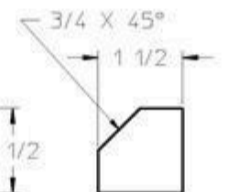

BENCH TOP TRIM
RIGHT SIDE VIEW

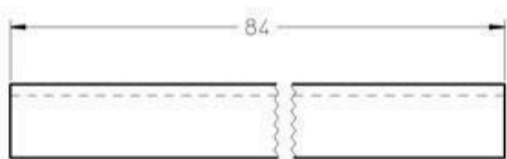

BACK WALL SLATS
QTY 14

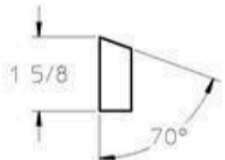

BACK WALL SLATS
RIGHT SIDE VIEW



Directions

1

PRINT PLANS

Download plans from the parts/cut list.

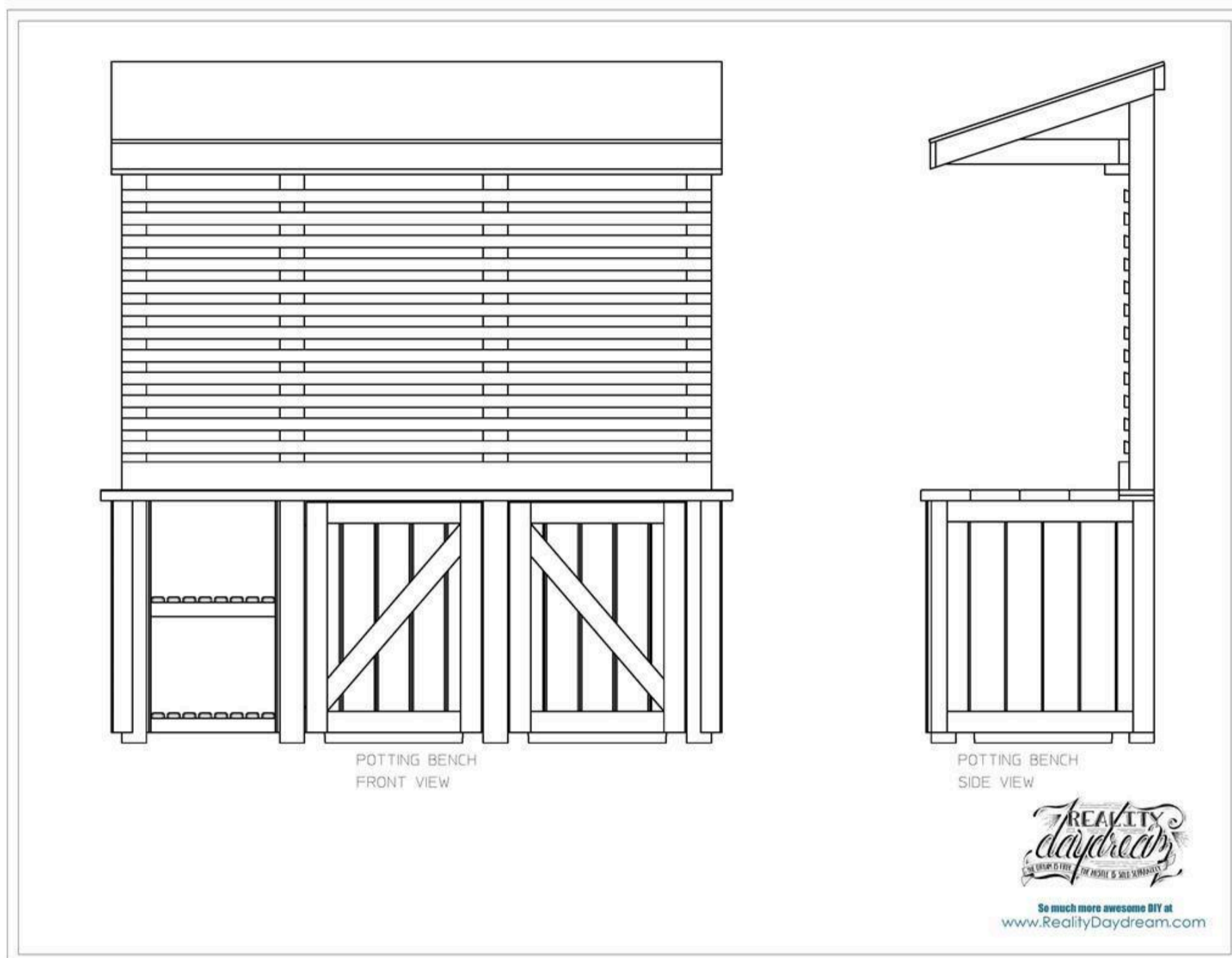

2**PREPARE THE SITE**

You will need to have a level site. we put in some rock and used 12" x 12" paver to set the legs on.



3

LEGS

Cut out all the components for the legs.

Using a Kreg jig, drill 2 pocket holes on each side of the part Leg top and bottom (should be 8 pocket holes total per part).

Mark the leg top and bottom locations (5" and 34 1/2").

Assemble the leg assembly.

Repeat for all four legs.



4**LEG ASSEMBLY**

Cut out the large and small leg dividers from 2X4's. Pocket hole 2 holes on both sides of the dividers. Screw to the leg assemblies at 5" and 34 1/2" high. Then mark the leg braces, drill pocket holes and screw them into place.



5**BENCH TOP**

Cut all the 2X8's and the 2X6 to size with the miter saw. For a smooth top surface (removing the rounded edges of the 2x8) you can rip the boards down on a table saw. Using a kreg jig we drilled pocket holes every ten inches down the length of the 2X8. Glue and screw the bench top together. Screw the 2X6 to the legs first, as the backsplash, then screw the benchtop to the legs (maintain the correct spacing of the legs at the front of the benchtop).

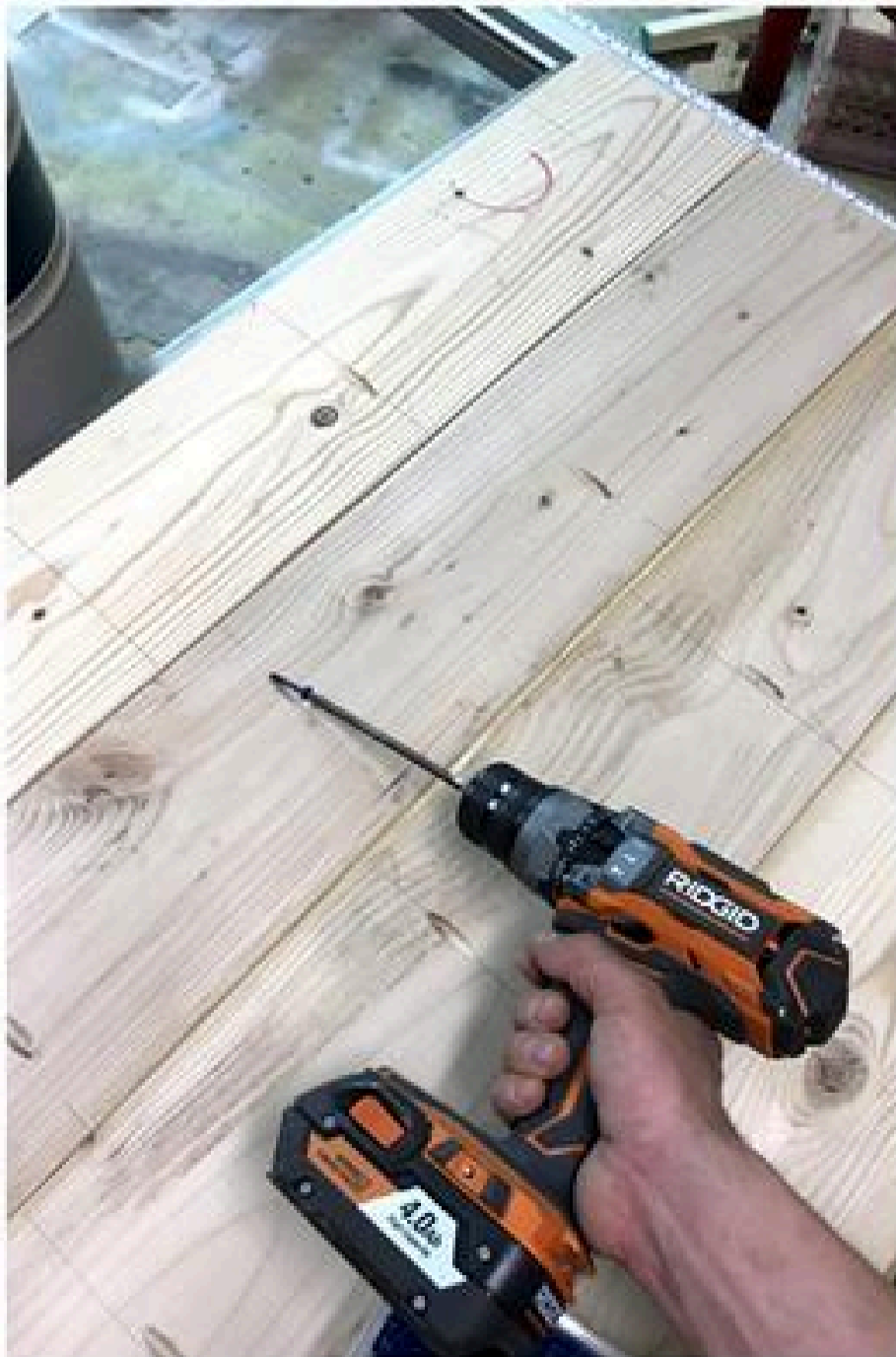

6**ROOF**

Cut out all the pieces for the Roof assembly. I have fancy table saw sled to cut the long angle of the roof truss brace, but you could just as easily use a circular saw. It is a 4/12 roof so to draw the angles, use a square and line up the 4" mark on one side of the square and the twelve inch mark on the other. Drill pocket holes in the end of the roof truss brace, the roof truss, and on edge of one of the bottom braces. Mark the truss spacing on each of the back, bottom, and front braces. Then screw the braces to the potting bench assembly (maintaining the appropriate leg spacing) and screw the trusses to the bracing. Lastly screw the front brace to the trusses and attach the plywood.

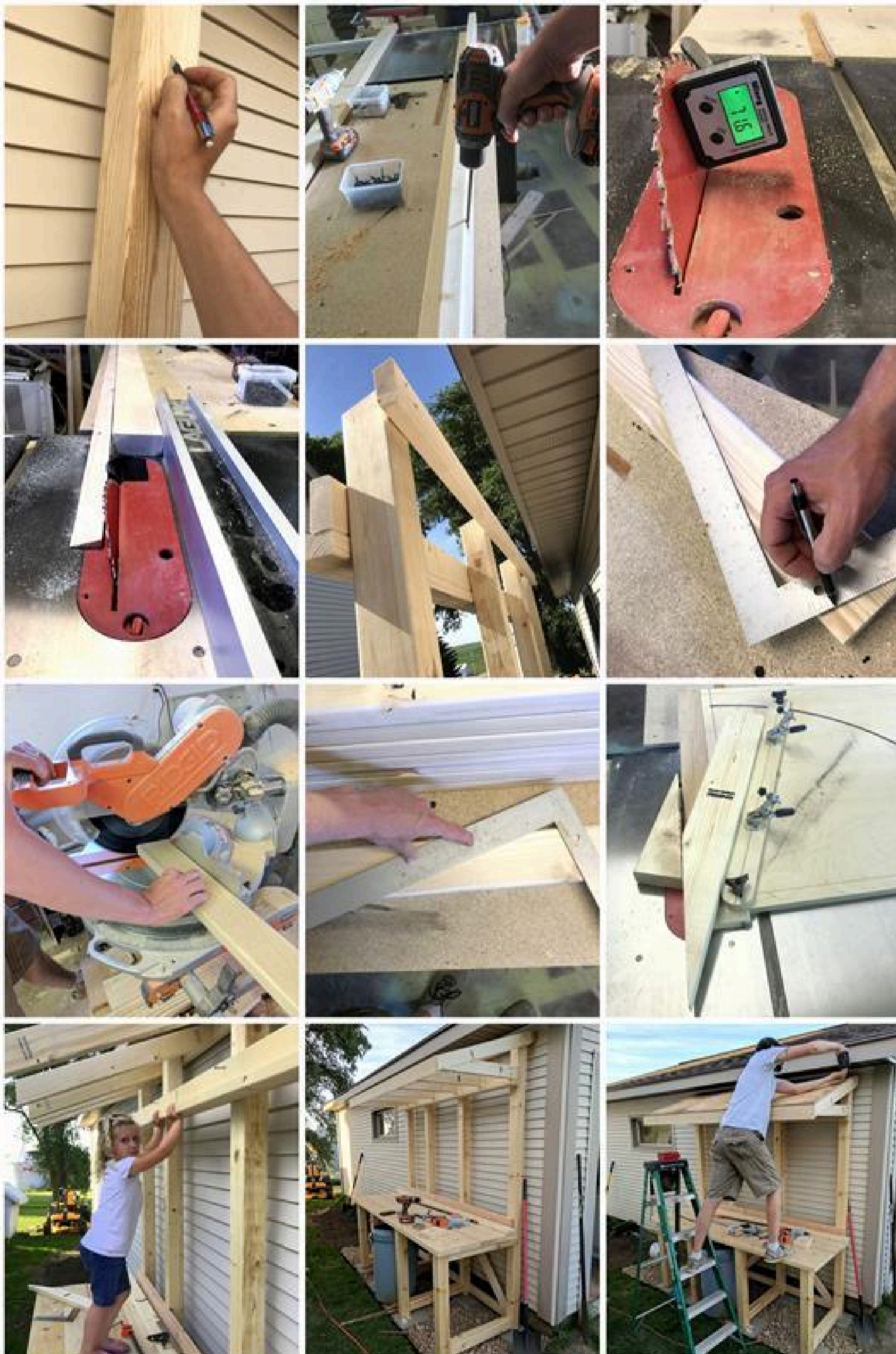

7**BACK BOARD**

Cut all the slats to size from the 1X6X96, using a miter saw and a tablesaw. We put an angle on the top side as a french cleat, in case we want to build shelves. Also cut out three blocks 1 1/4" wide to use as spacers. Grab your pile of slats, starting just above the backsplash screw them to the leg assembly using the T10 finishing screws.



8

SIDES

Cut all the side boards to length and width. Then set the cut a 45* x 3/16 angle on the edges of the side boards. 4 of the boards i only cut the angle on one side, to be used as the ends. Then I laid out 6 boards for each side, marked where I wanted the pocket holes (4 on each side board). Glue and screw the side boards together. Then cut the side, top and bottom trim pieces to size. Drill 2 pocket holes on each end of the top and bottom trim piece. Screw it all together to make a frame. then glue and nail it to the side boards. Lastly, screw the side assemblies to the sides of the potting bench.

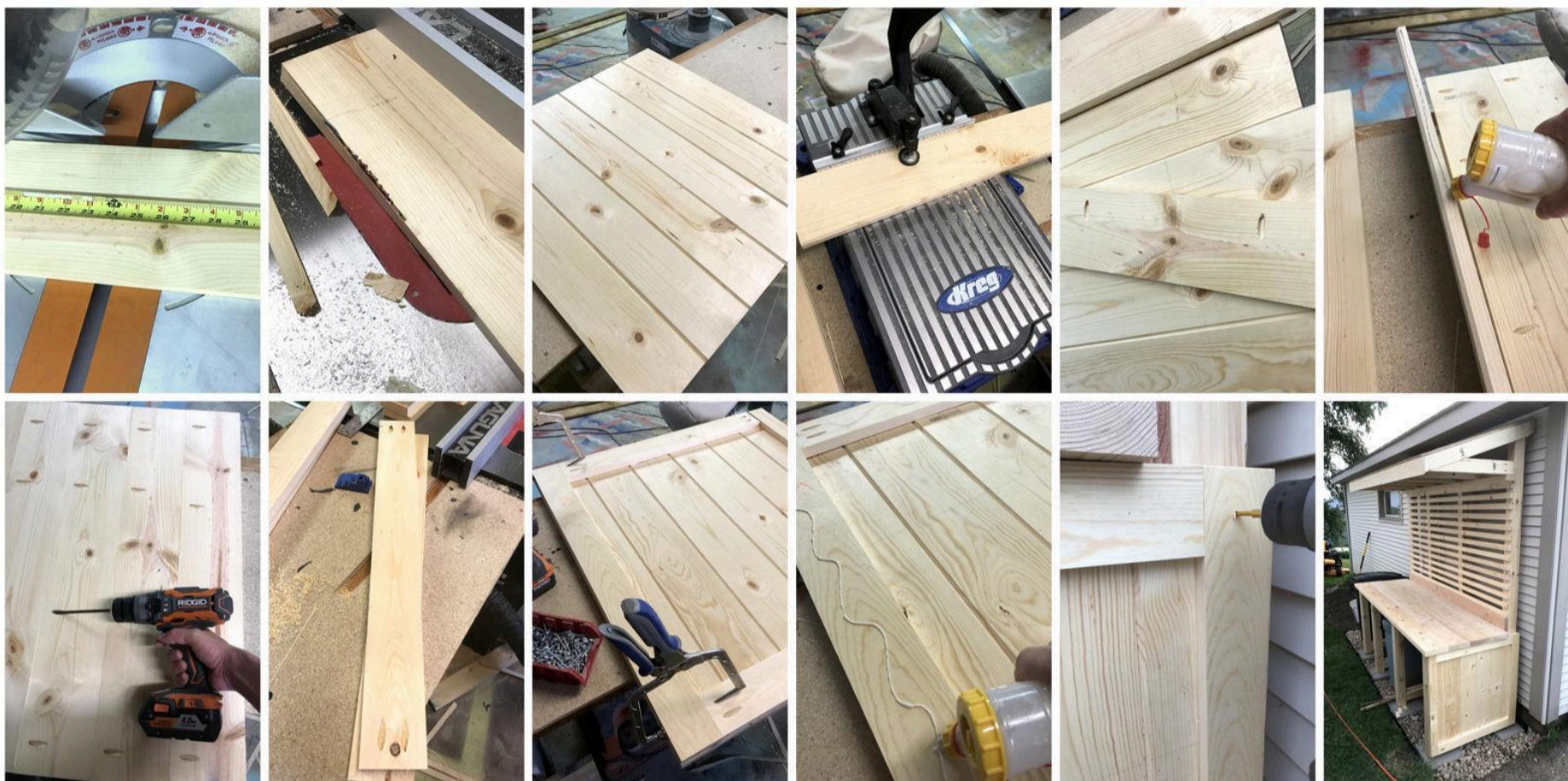

9**DOORS**

The doors are built a lot like the sides, so cut all your pieces to size, cut the 3/16" angle on the door boards and screw together. Then cut, drill and screw the door trim pieces together, to build the frame. Before attaching it to the door boards, mark the door trim brace. Cut it to size and screw it to the door trim. Then screw the trim to the door boards. Using T10 finishing screws. Attach the hardware to the doors and the potting bench.

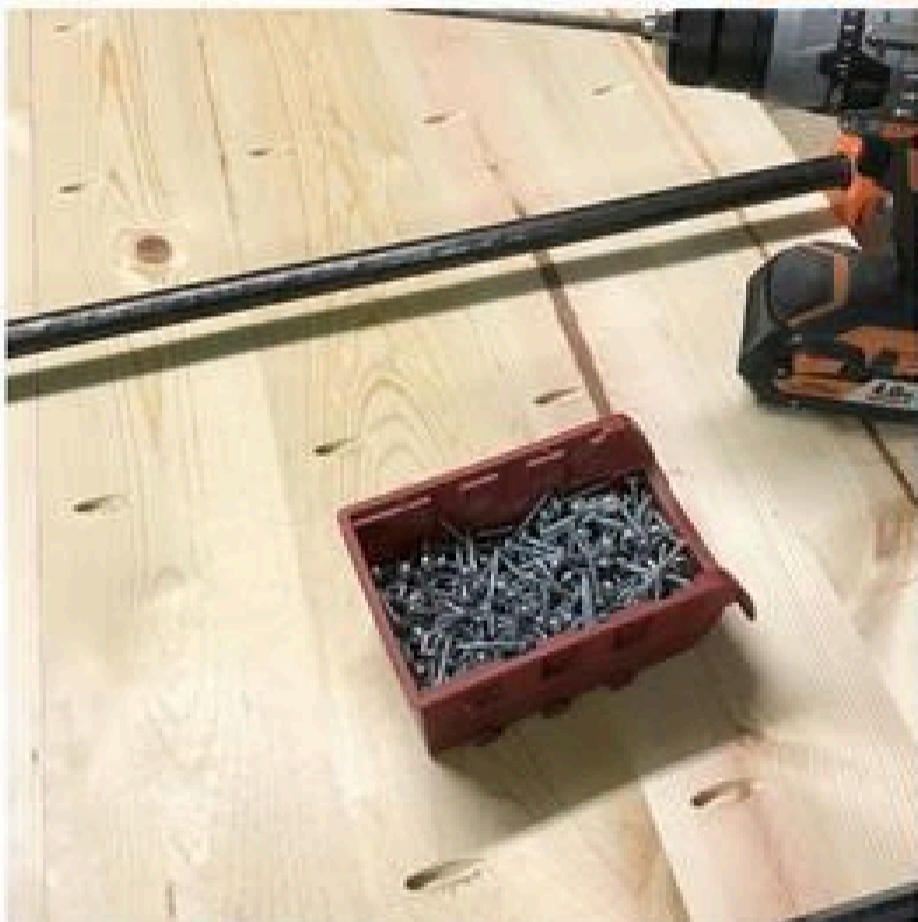

10**SHELVES**

Start by cutting out the plywood for the shelf backs and sides. Screw the plywood back to the legs first and then the sides. We wanted to isolate the shelves from the other two compartments (keeping things from falling off the shelf). Cut out remaining shelf components. Drill pocket holes on both ends of the Shelf back/divider and on end of the shelf sides, then assemble. To make things easy we mounted the bottom shelf first, Cut the slats and screwed the to the shelf before doing the middle shelf. The slats are cut to size and rounded with a round over router bit. Then nail (18 ga) to the shelf. We used a scrap piece of 1/4" and 1/2" ply to keep our spacings.

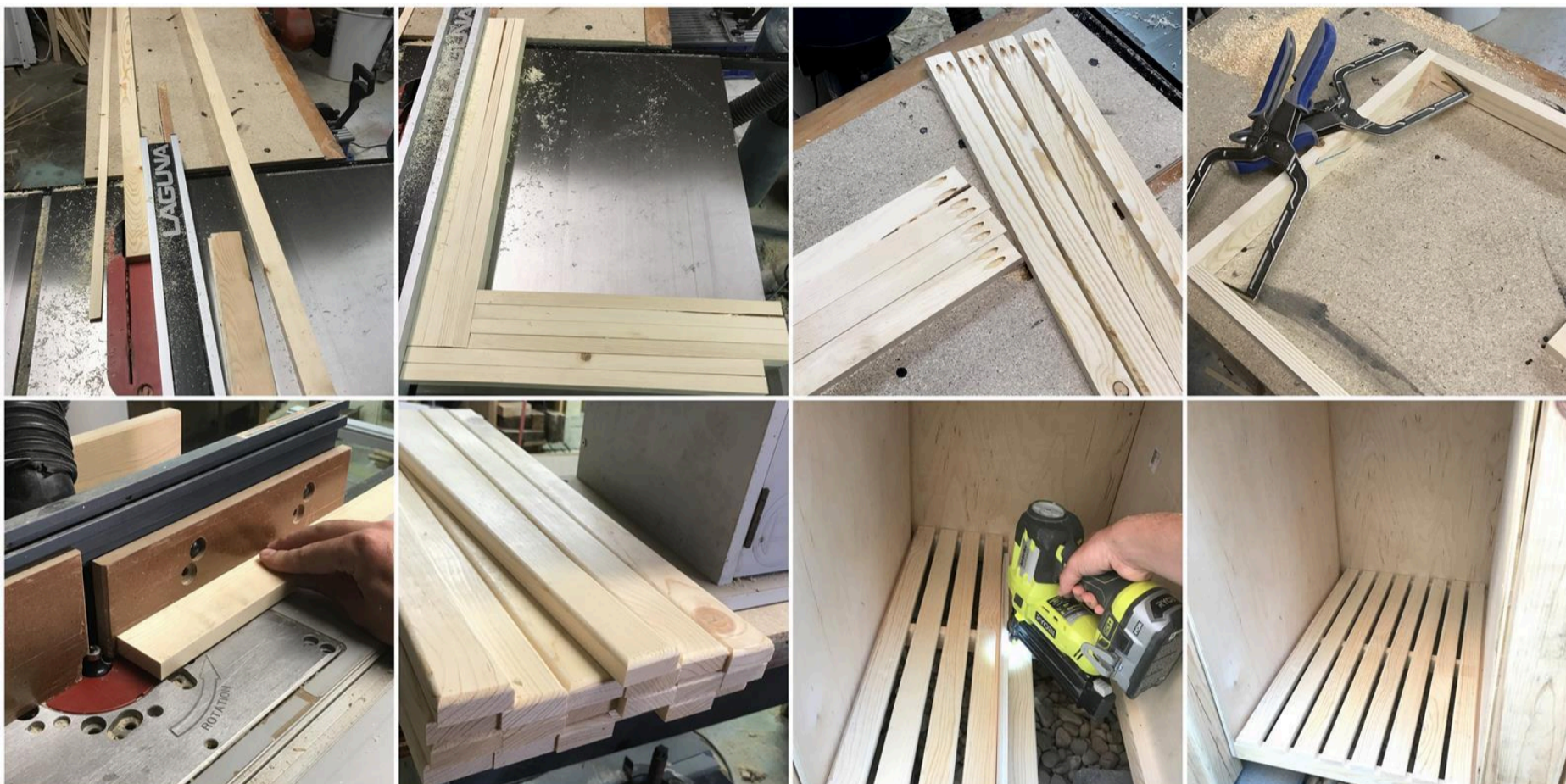

11

TRIM

lastly, cut all the trim pieces out and screw them to their respective location on the potting bench.

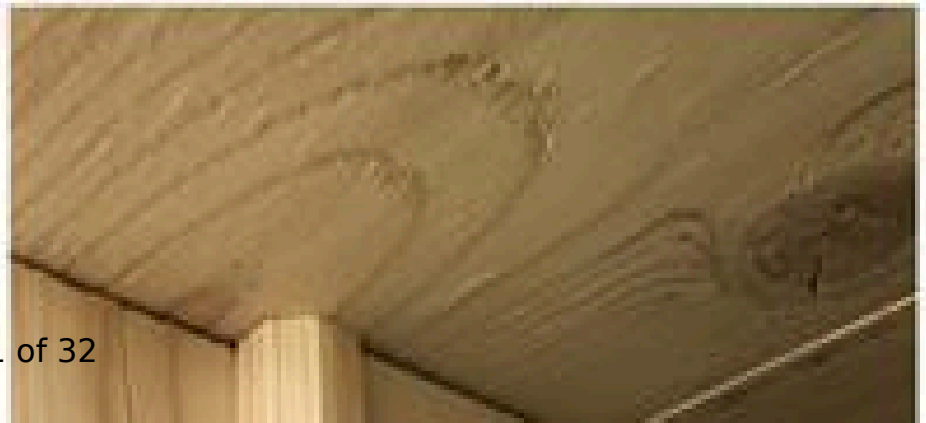
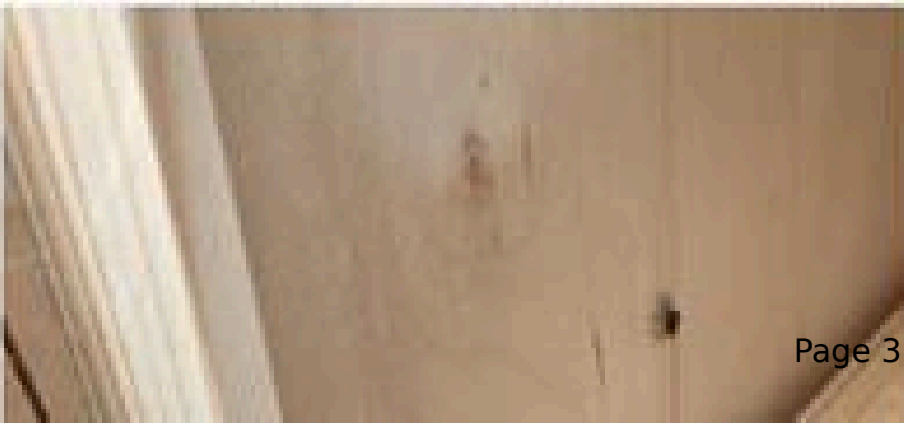
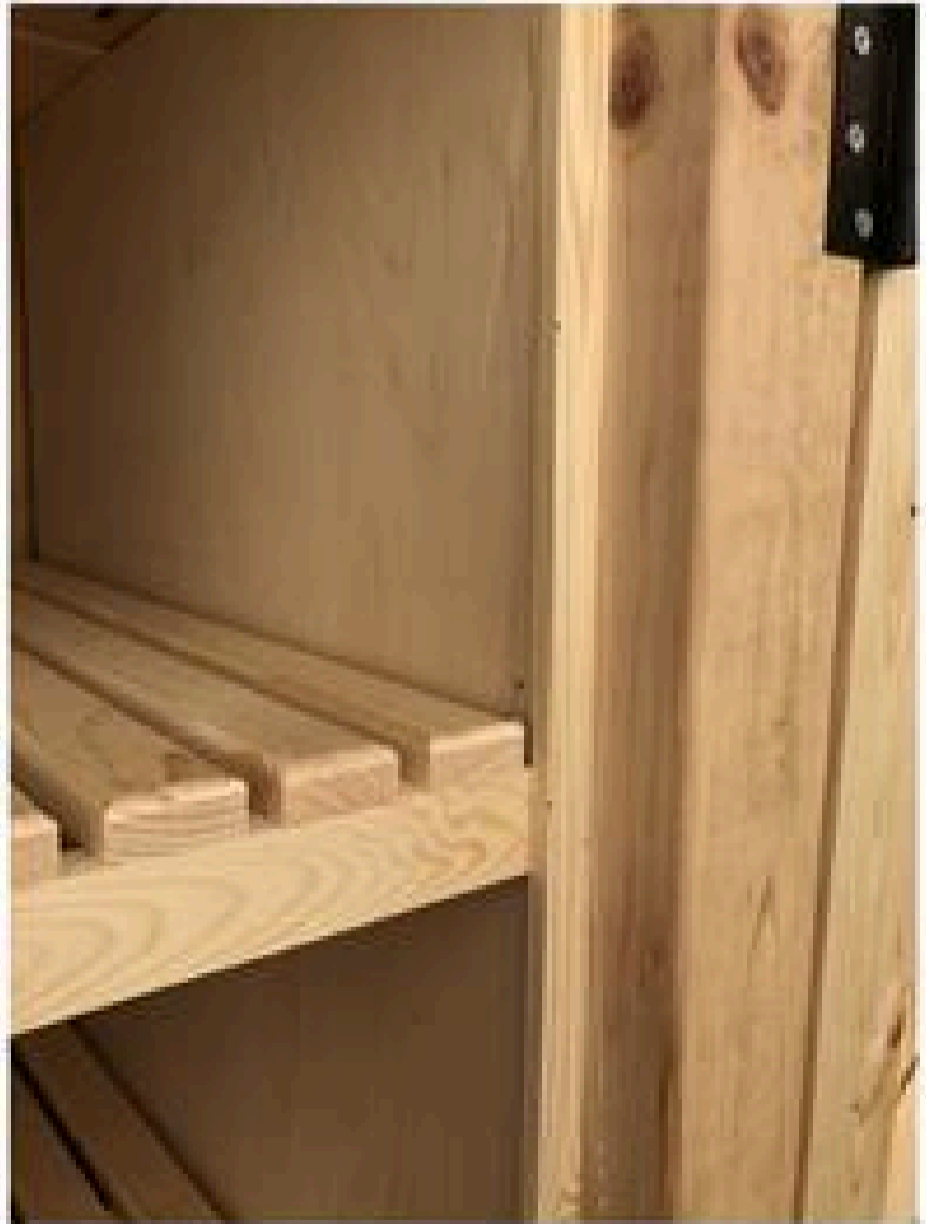

12

Paint and Shingles!

Come on over to our blog to see how we finished this baby of with a coat of primer/paint and shingles on the roof. It turned out SO GOOD!

<http://realitydaydream.com/the-painting-of-the-potting-bench/>
