

Decorative Wall Mirror

By **Kreg Tool**

Difficulty

Easy

With its extended rails, raised squares, and beveled glass, this decorative mirror recreates a classic Arts & Crafts style. You might think those features would make this project tough to build, but it's actually incredibly easy. All you need are some stock boards, plywood, and a pre-cut mirror.

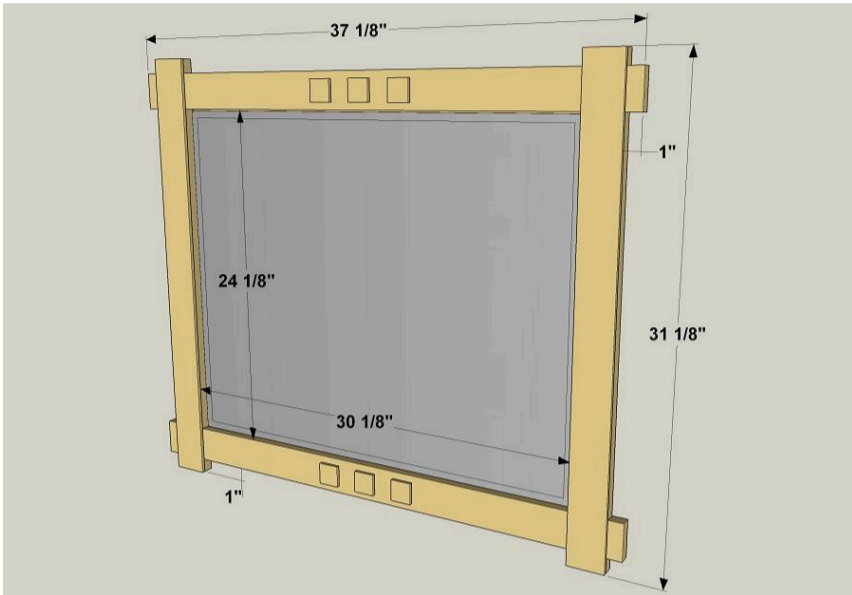

Tools

Kreg Tools



Other Tools

Miter Saw

Tape Measure

Drill (cordless)

Sander

Materials

Wood Products

- 1 Board , 1x3 , 96"
- 1 Board , 1x3 , 48"
- 2 Board , 1/4" X 3" , 24"
- 1 Plywood , 1/4" Thick , Half Sheet

Hardware & Supplies

- 8 1 1/4" Fine-thread Pocket Hole Screws
- 16 #6 X 3/4" Pan-head Woodscrews
- 1 Heavy Duty Mirror/Picture Frame Hanging Kit
- 1 24" X 30" Beveled Mirror
- 1 Mirror Adhesive
- 1 Wood Glue

Cut List & Parts

- 2 Rail, 3/4" X 2 1/2" X 30 1/8" Oak
- 2 Stile, 3/4" X 2 1/2" X 31 1/8" Oak
- 2 Thin Stile, 1/4" X 2 1/2" X 31 1/8" Oak
- 4 Rail End, 3/4" X 2 1/2" X 1" Oak
- 6 Decorative Square, 1/4" X 1 1/2" X 1 1/2" Oak
- 1 Back, 1/4" Ply X 27" X 33"

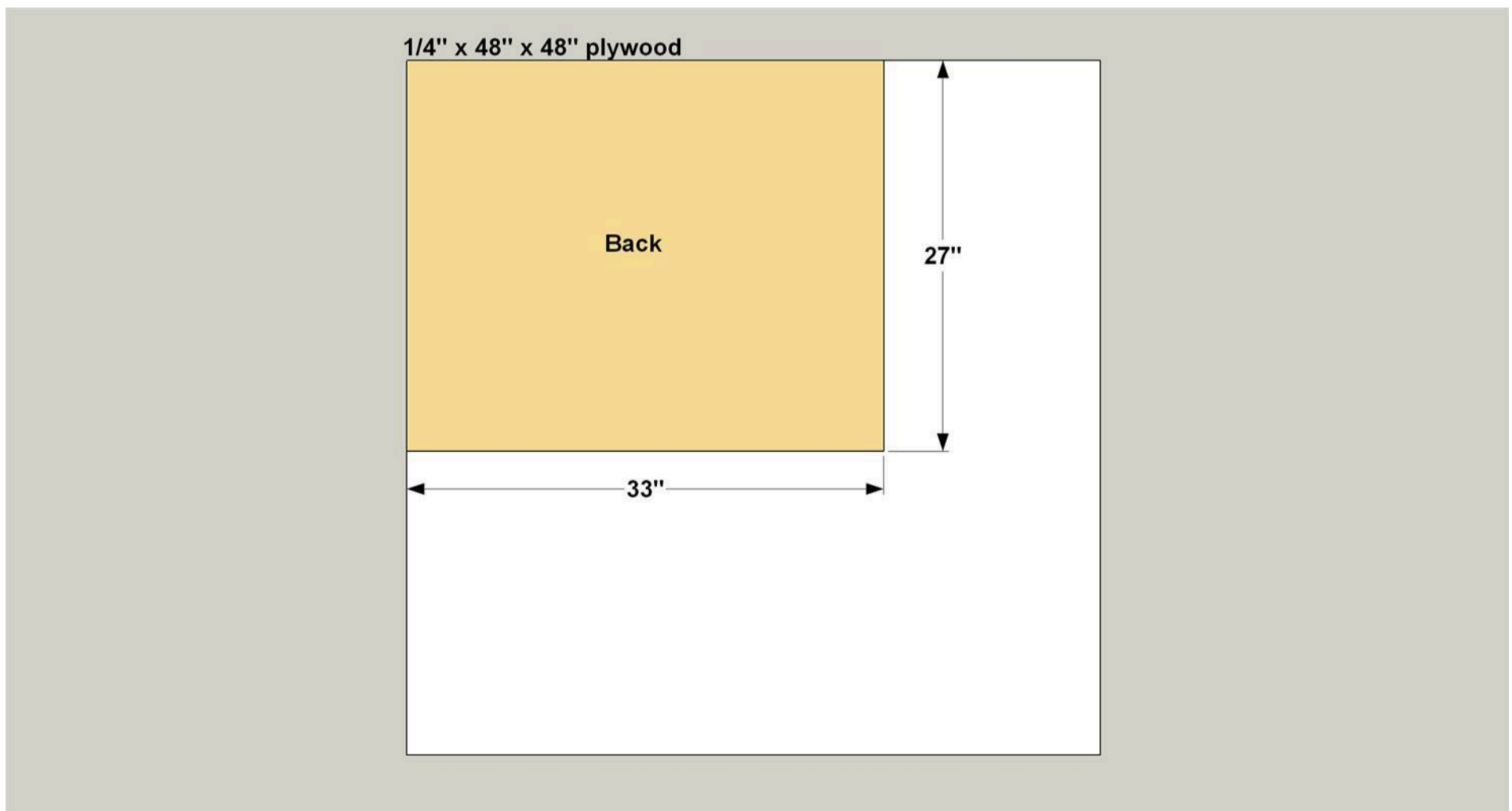
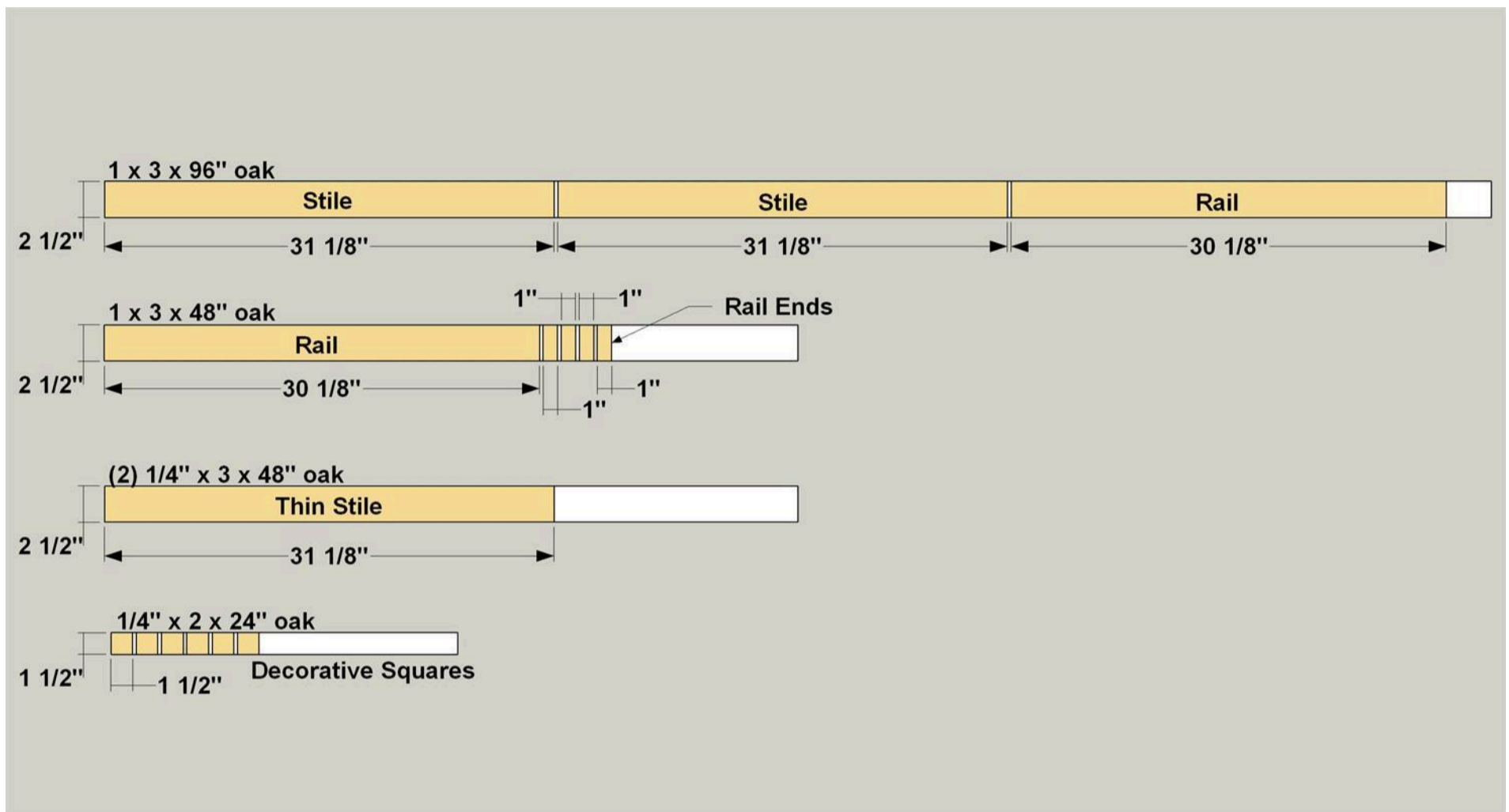

Directions

1

Make the Rails

Cut two Rails to length from a 1x3 oak board, as shown in the cutting diagram. Set your pocket hole jig for 3/4" material, and then drill pocket holes in the Rails at the locations shown.



2

Cut the Rail Ends and Stiles

Cut four End Rails to length from a 1x3 oak board, as shown in the cutting diagram. Sand them smooth, and then set them aside for now. These Rail Ends will get glued in place later. Also cut two Stiles from a 1x3 oak board, as shown in the cutting diagram. Sand the Stiles smooth, too.

3

Add Thin Stiles

Now cut two Thin Stiles from a 1/4"x3 oak board, as shown in the cutting diagram. These should match the thicker Stiles you cut from a 1x3. Now glue the Thin Stiles to the Stiles, as shown. Make sure the edges and ends are flush. Then, clamp the assemblies, or wrap them tightly with strips of masking tape, until the glue dries. When the glue dries, sand the edges so they are even and smooth.

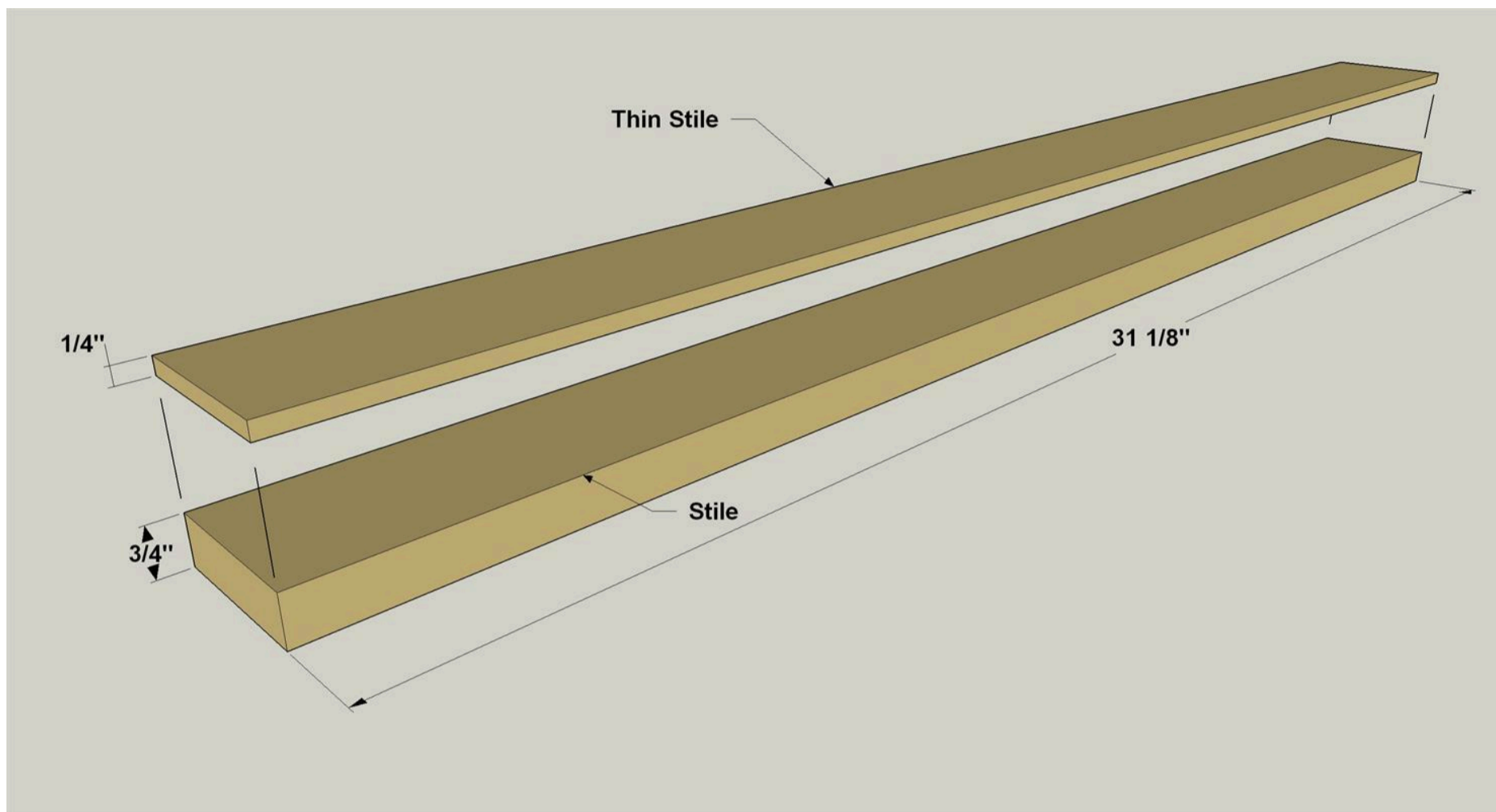

4

Assemble the Frame

Attach the Rails to the two stile assemblies using 1 1/4" fine-thread pocket hole screws, as shown. Note that the Rails sit flush with the rear face of the thicker stiles.

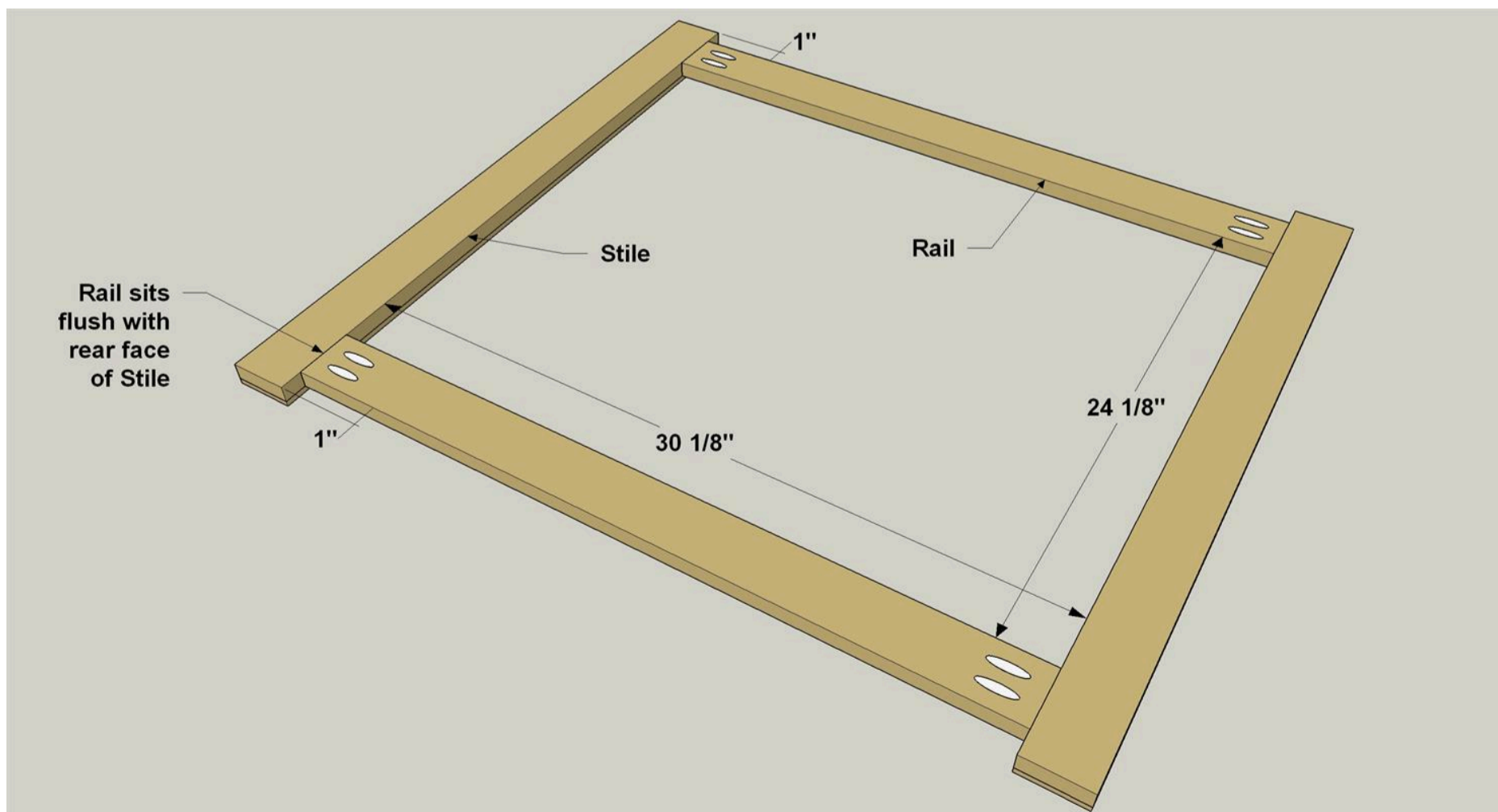

5

Add the Rail Ends

Now you can create the look of extended rails. To do that, glue the Rail Ends to the stiles at the locations shown. Make sure that the Rail Ends are aligned with the Stiles, and that they are flush with the rear face of each stile. Use clamps or tape to hold them in place while the glue dries.

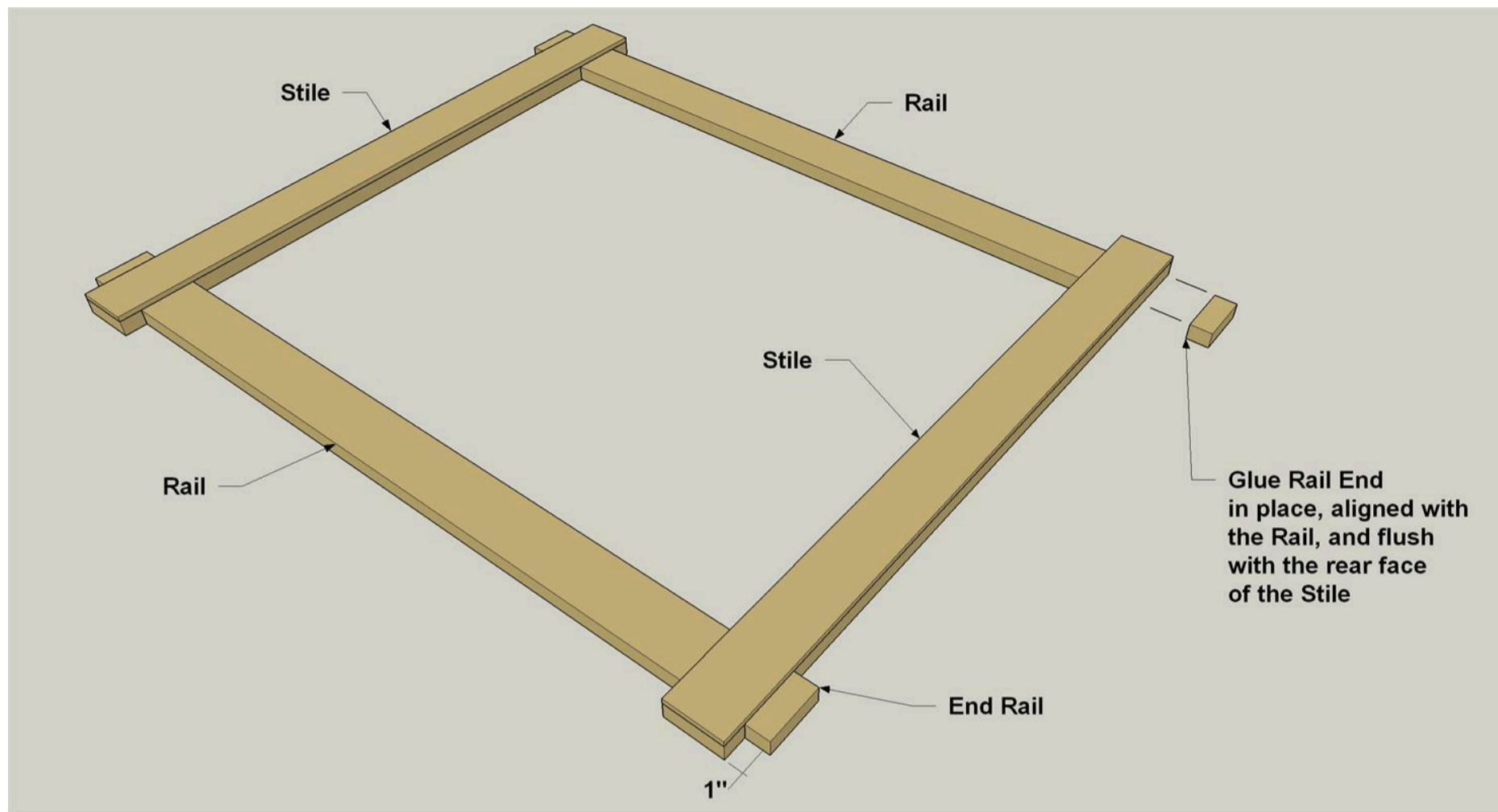

6

Cut and Apply Decorative Squares

Cut six Decorative Squares, as shown in the cutting diagram. Dab some glue on the back of each one and set them on the Rails at the locations shown. An adjustable square is helpful here to get these pieces aligned.

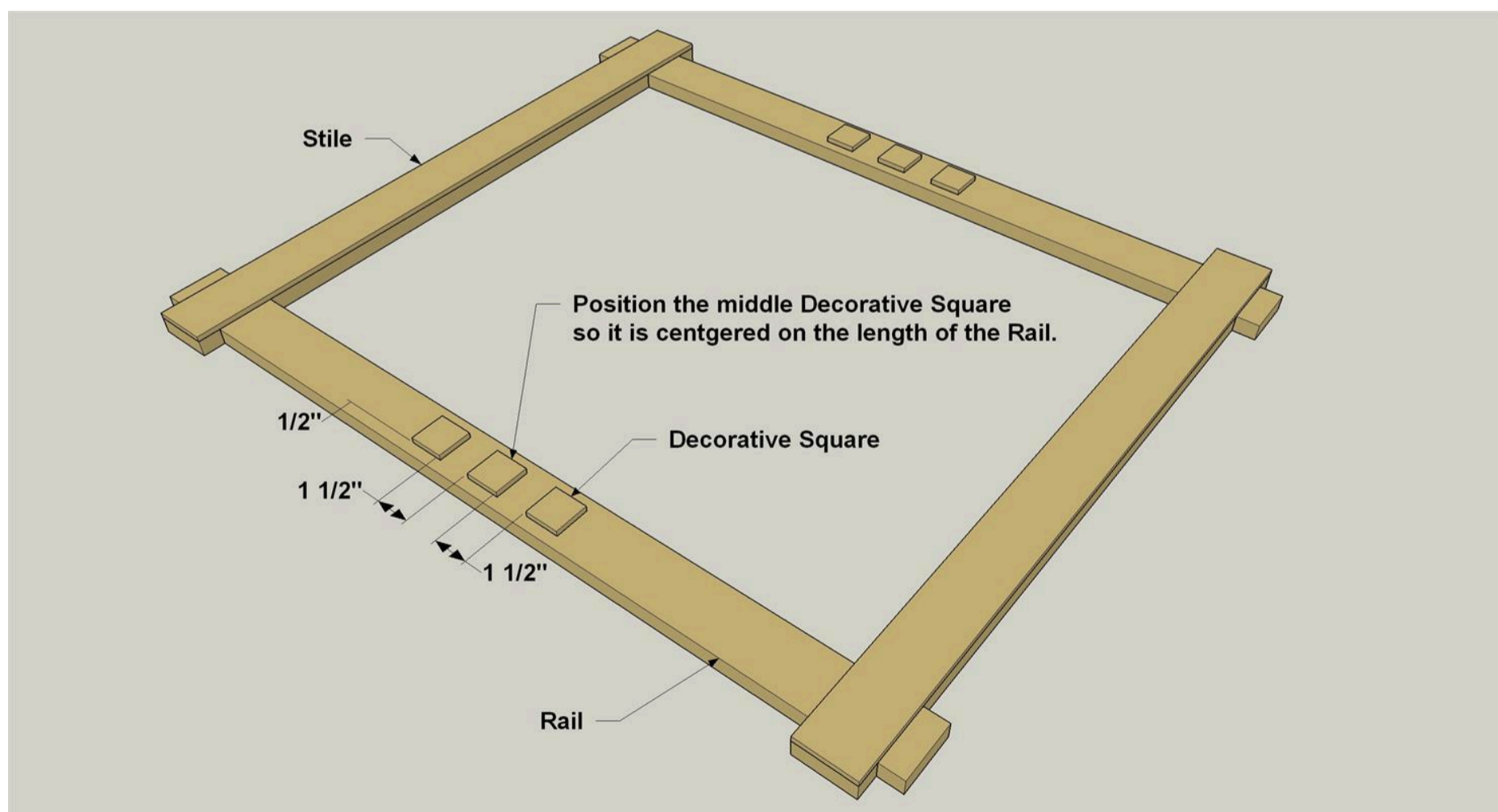

7**Cut the Plywood Back**

Cut the Back from 1/4" plywood as shown. Drill holes at the locations shown for screws that will be used to attach the Back to the mirror frame.

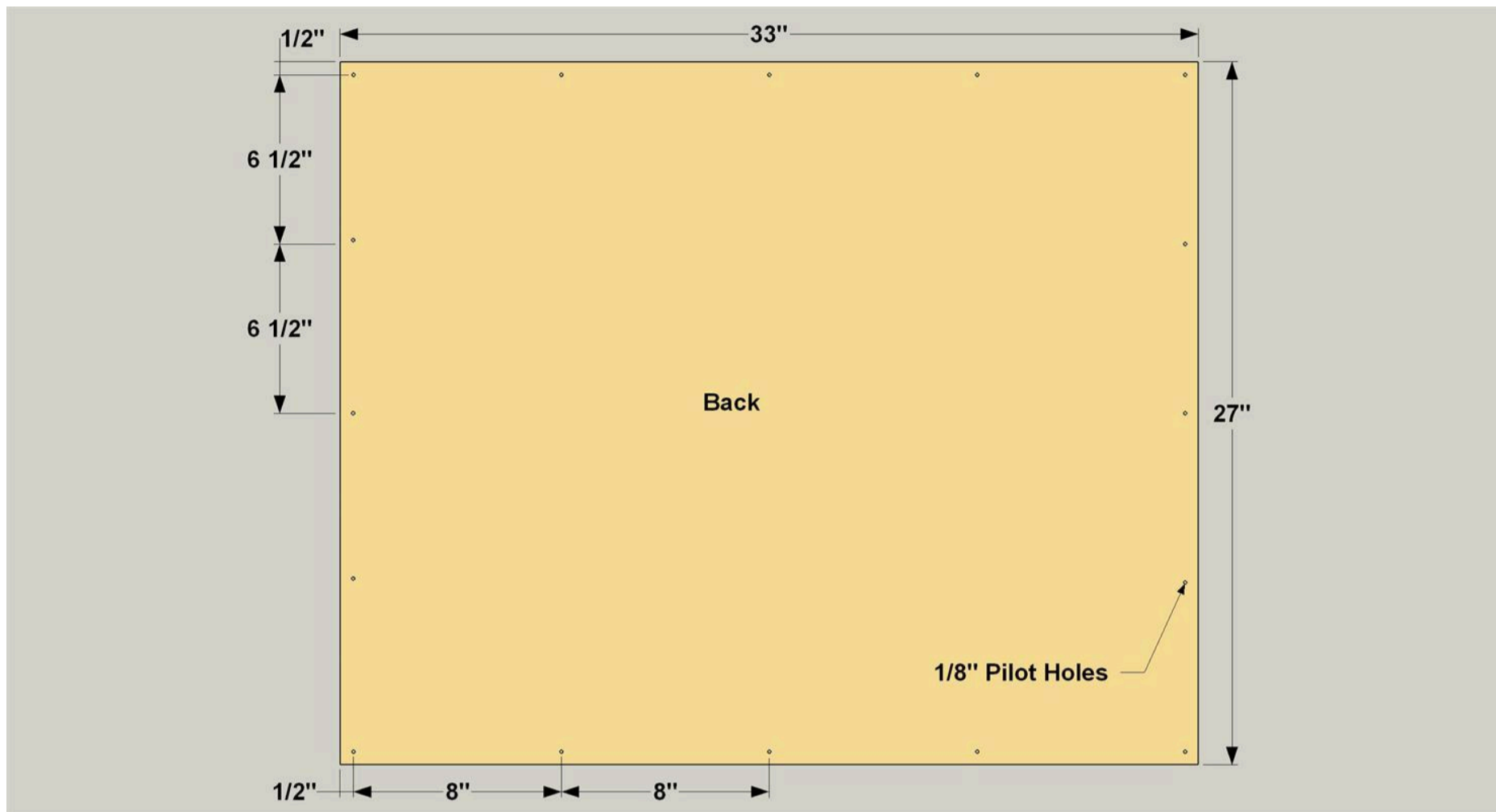
**8****Stain and Finish**

Sand the mirror assembly, wipe it down to remove the dust, and then apply your favorite stain and top-coat.

9**Install the Back**

Screw the Back to the frame assembly using #6 x 3/4" pan-head screws, as shown.

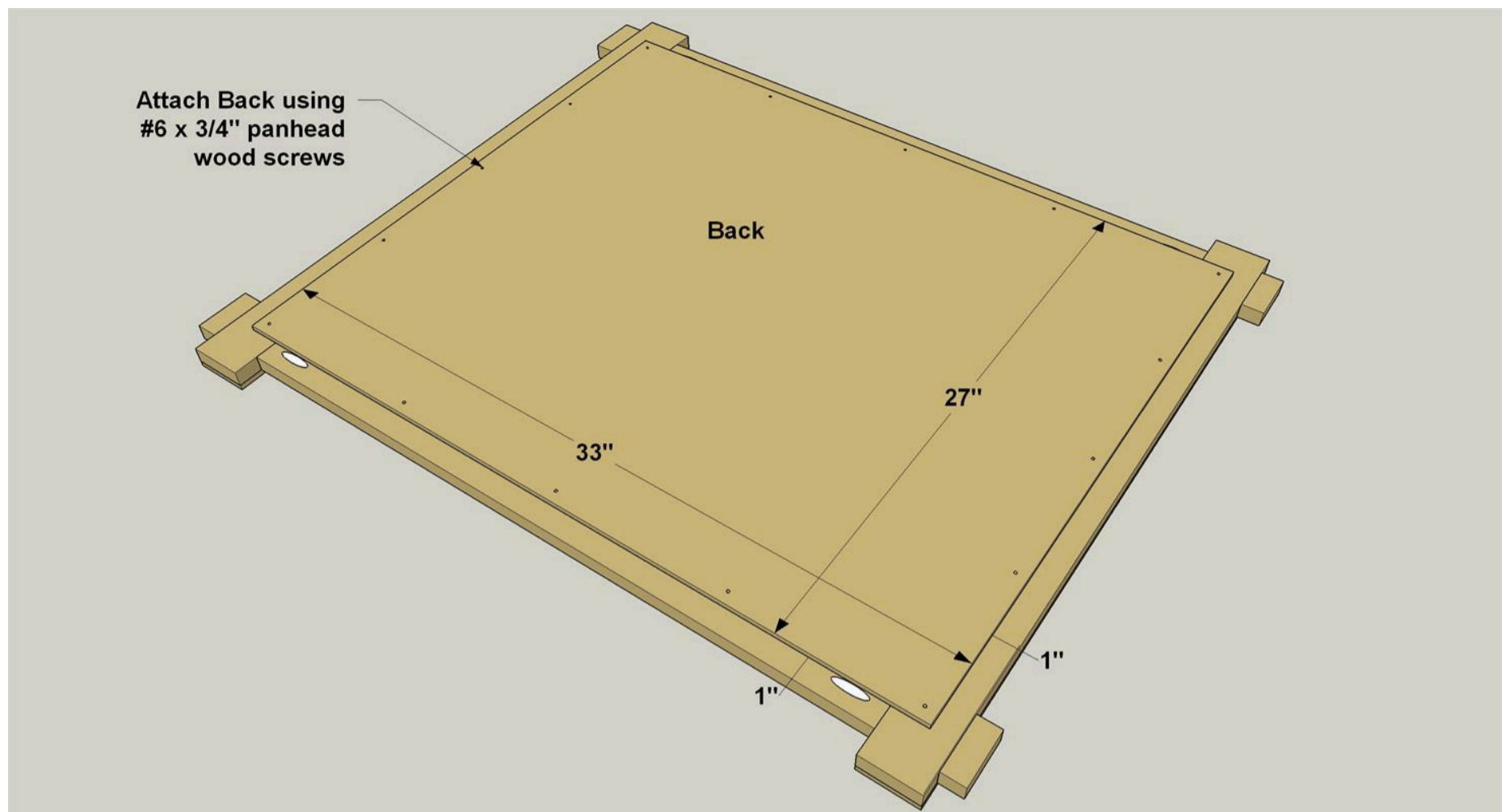
**10****Add the glass**

Now you can add the glass mirror. It simply gets adhered to the plywood. For a mirror, though, you need to use the proper type of adhesive. Ordinary glue or construction adhesive can actually pull the silver coating off of the glass. So, make sure you get mirror adhesive. It's widely available. Follow the instructions to apply adhesive to the plywood, and then press the mirror in place. There should be a small gap between the edges of the mirror and the inside edges of the frame. Make sure the adhesive dries per the manufacturer's instructions before you add the hardware and hang the mirror.

11**Hang the Completed Mirror**

Add a hanging bracket or "D" rings and wire to hang the mirror. Make sure you screw any hanging mechanism into the solid wood part of the frame. Also, make sure any hanging hardware is rated for the appropriate weight of the mirror. Then, hang the mirror on your wall, and enjoy the view.