

# Apothecary Cabinet

By **Kreg Tool**

Difficulty

Advanced

This cabinet borrows its styling from the metal cabinets that were once commonplace in doctor's and dentist's offices. This one, though, is made from plywood and dimensional boards you can pick up at a home center. Glass panels give it personality, and offer a chance to hone your router skills.

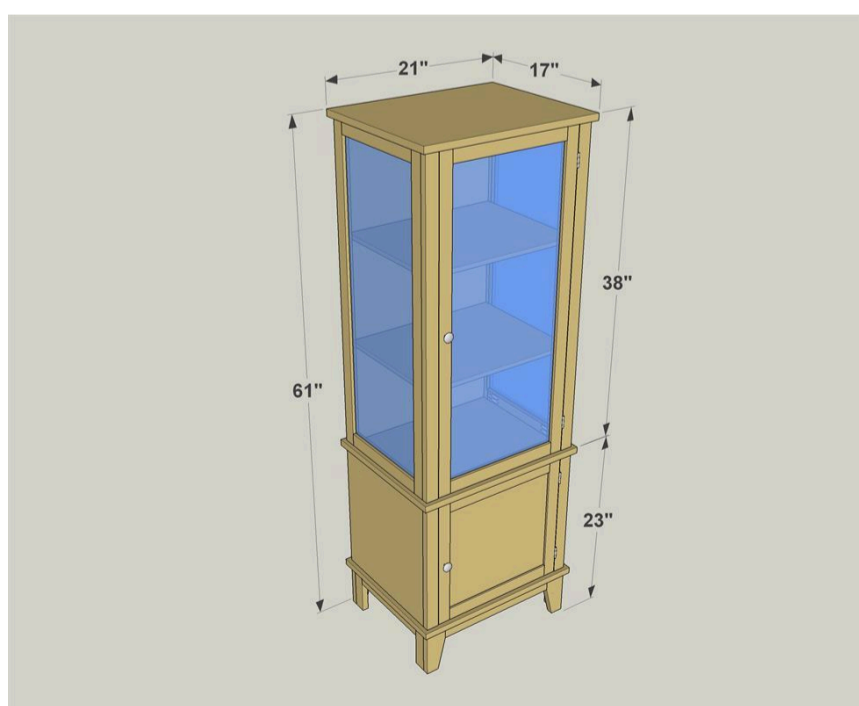

# Tools

## Kreg Tools



[Kreg® Pocket-Hole Jig 720](#)

## Other Tools

Circular Saw (corded)

Jigsaw

Miter Saw

Tape Measure

Drill (cordless)

Router

Rabbeting Bit

Sander

# Materials

## Wood Products

- 1 Plywood , 3/4" Thick , Full Sheet
- 1 Plywood , 1/2" Thick , Half Sheet
- 6 Board , 1x2 , 96"
- 1 Board , 1x3 , 24"
- 8 Square Dowel , 1/4" , 48"

## Hardware & Supplies

- 108 1 1/4" Coarse Pocket Hole Screws
- 22 1" Coarse Pocket Hole Screws
- 1 25' Roll Iron-on Edge Banding
- 2 1" Diameter Door Pulls
- 2 Pairs 1 1/2" No-mortise Door Hinges
- 2 1/8" Glass, 12 5/8" X 34 5/8"
- 1 1/8" Glass, 14 1/4" X 34 1/2"

# Cut List & Parts

- 1 Bottom , 3/4" Ply X 17" X 21"
- 1 Divider , 3/4" Ply X 17" X 21"
- 1 Top , 3/4" Ply X 17" X 21"
- 1 Lower Back , 3/4" Ply X 18 1/2" X 16"
- 1 Upper Back , 3/4" Ply X 18 1/2" X 37 1/4"
- 2 Side , 3/4" Ply X 15 1/4" X 16"
- 2 Shelf , 1/2" Ply X 13 7/8" X 12 7/8"
- 4 Front/Back Leg , 3/4" X 2 1/2" X 5 1/2"
- 4 Side Leg , 3/4" X 1 1/2" X 5 1/2"
- 2 Base Front/Back Rail , 3/4" X 1 1/2" X 15"
- 2 Base Side Rail , 3/4" X 1 1/2" X 11 1/2"
- 2 Lower Front Stile , 3/4" X 1 1/2" X 16"
- 2 Upper Front Stile , 3/4" X 1 1/2" X 37 1/4"
- 4 Side Stile , 3/4" X 1 1/2" X 37 1/4"
- 4 Side Rail , 3/4" X 1 1/2" X 12 1/4"
- 2 Upper Door Stile , 3/4" X 1 1/2" X 37 1/8"
- 2 Upper Door Rail , 3/4" X 1 1/2" X 13 7/8"
- 2 Lower Door Stile , 3/4" X 1 1/2" X 15 1/8"
- 2 Lower Door Rail , 3/4" X 1 1/2" X 13 7/8"
- 4 Long Side Glass Top , 1/4" X 1/4" X 34 3/4"
- 4 Short Side Glass Stop , 1/4" X 1/4" X 12 1/4"
- 2 Long Door Glass Stop , 1/4" X 1/4" X 34 5/8"
- 2 Short Door Glass Stop , 1/4" X 1/4" X 13 7/8"
- 1 Door Panel , 1/2" Ply X 13 7/8" X 12 7/8"

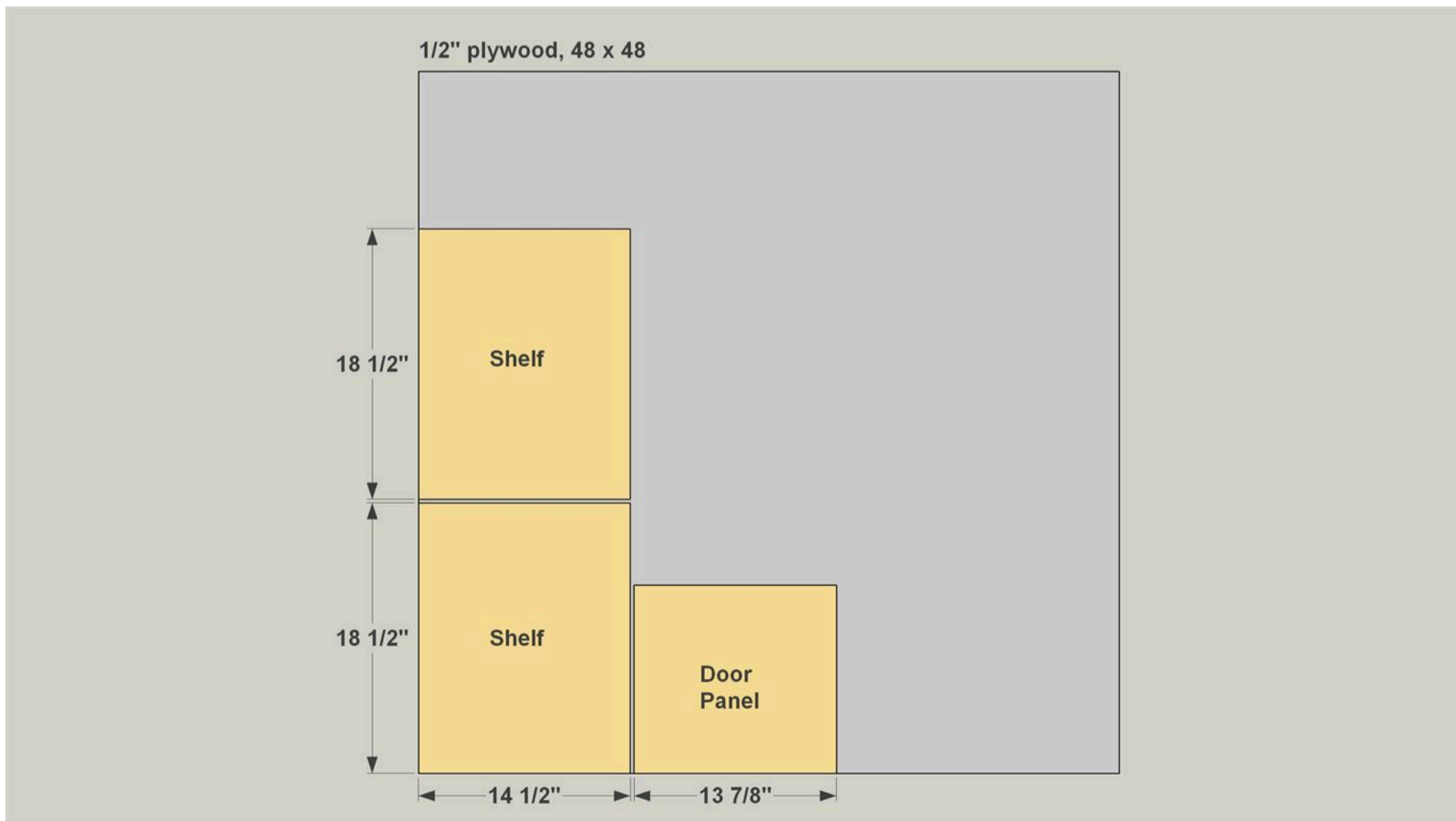

3/4" plywood, 48 x 96

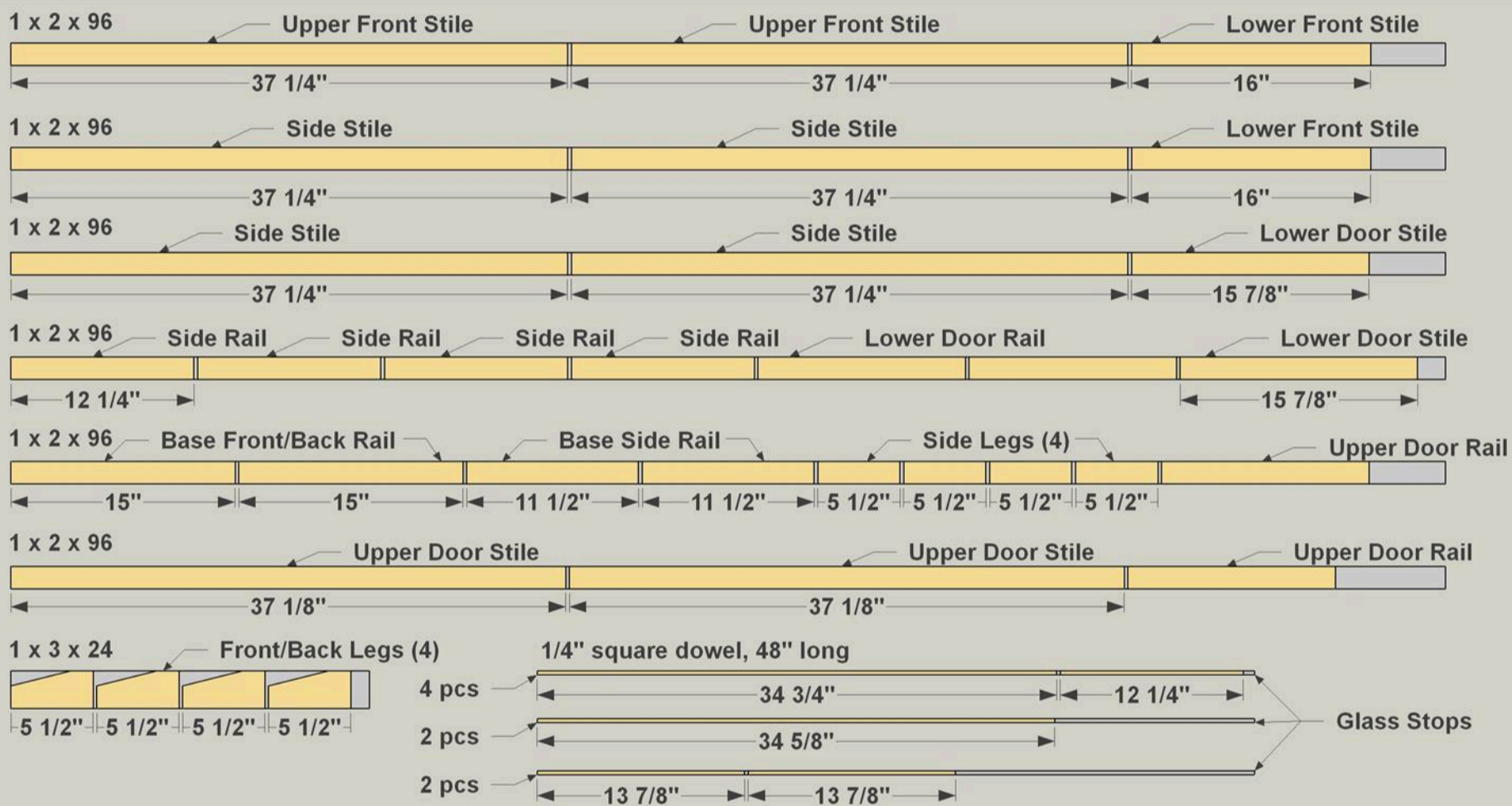
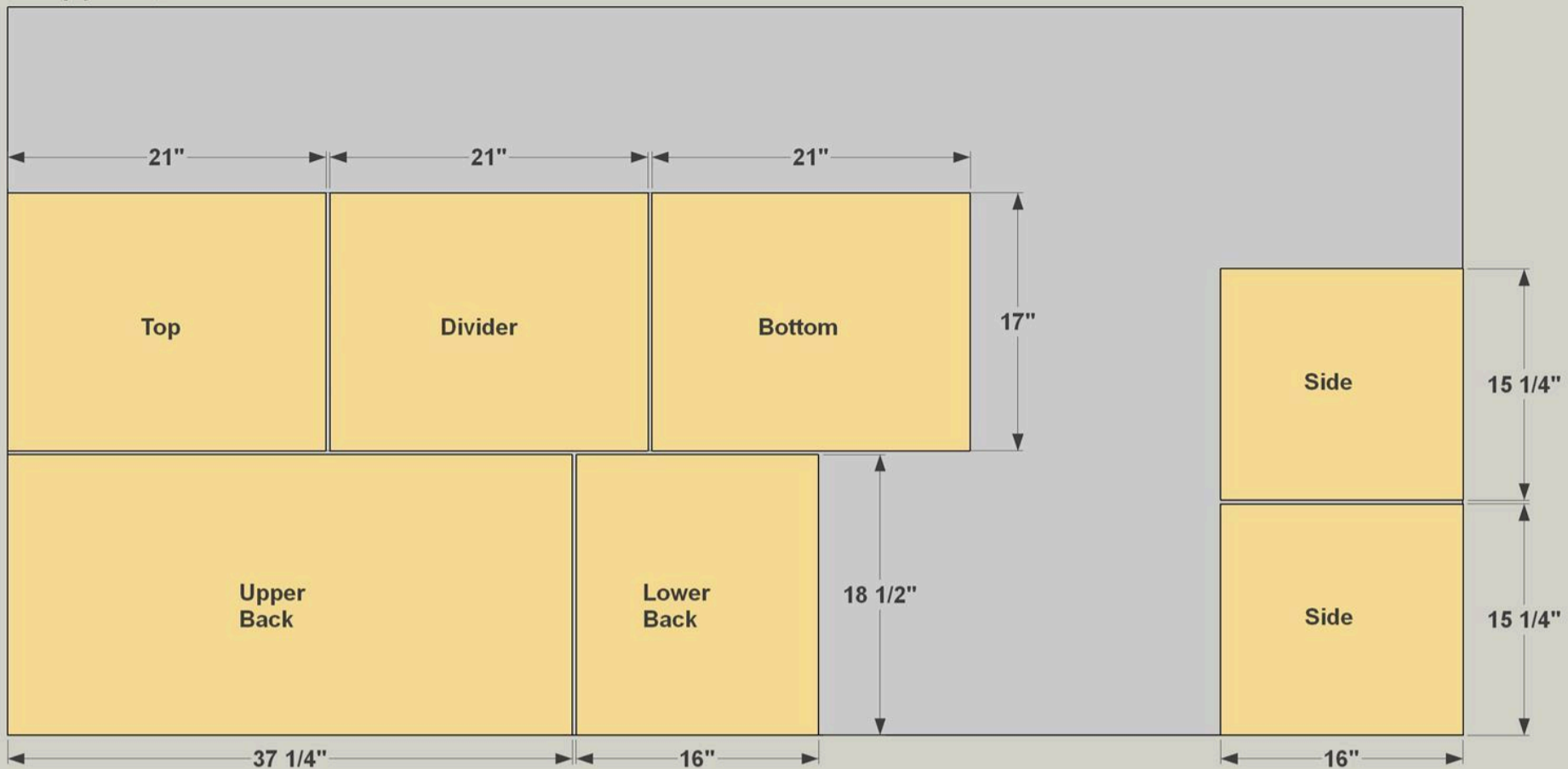

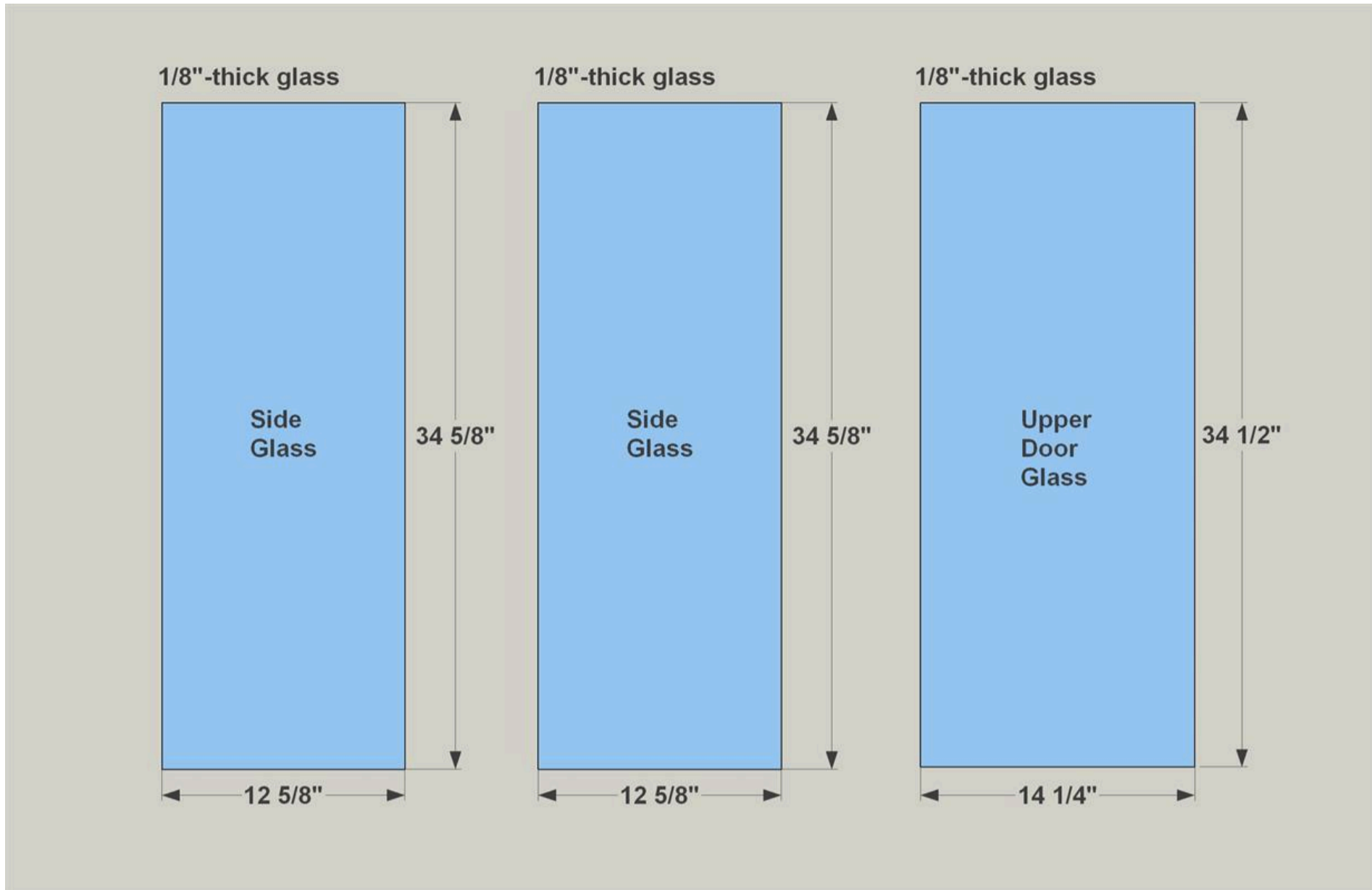

# Directions

**1****Begin with the Base**

Cut two Base Front/Back Rails, two Base Side Rails, and four Base Side Legs to length from 1x2 boards (we used pine), as shown in the cutting diagram. Also cut four Base Front/Back Legs. Then cut the angle on the Front/Back Legs using a jigsaw. With your pocket-hole jig set up for 3/4" stock, drill pocket holes where shown in all of these pieces, as shown.

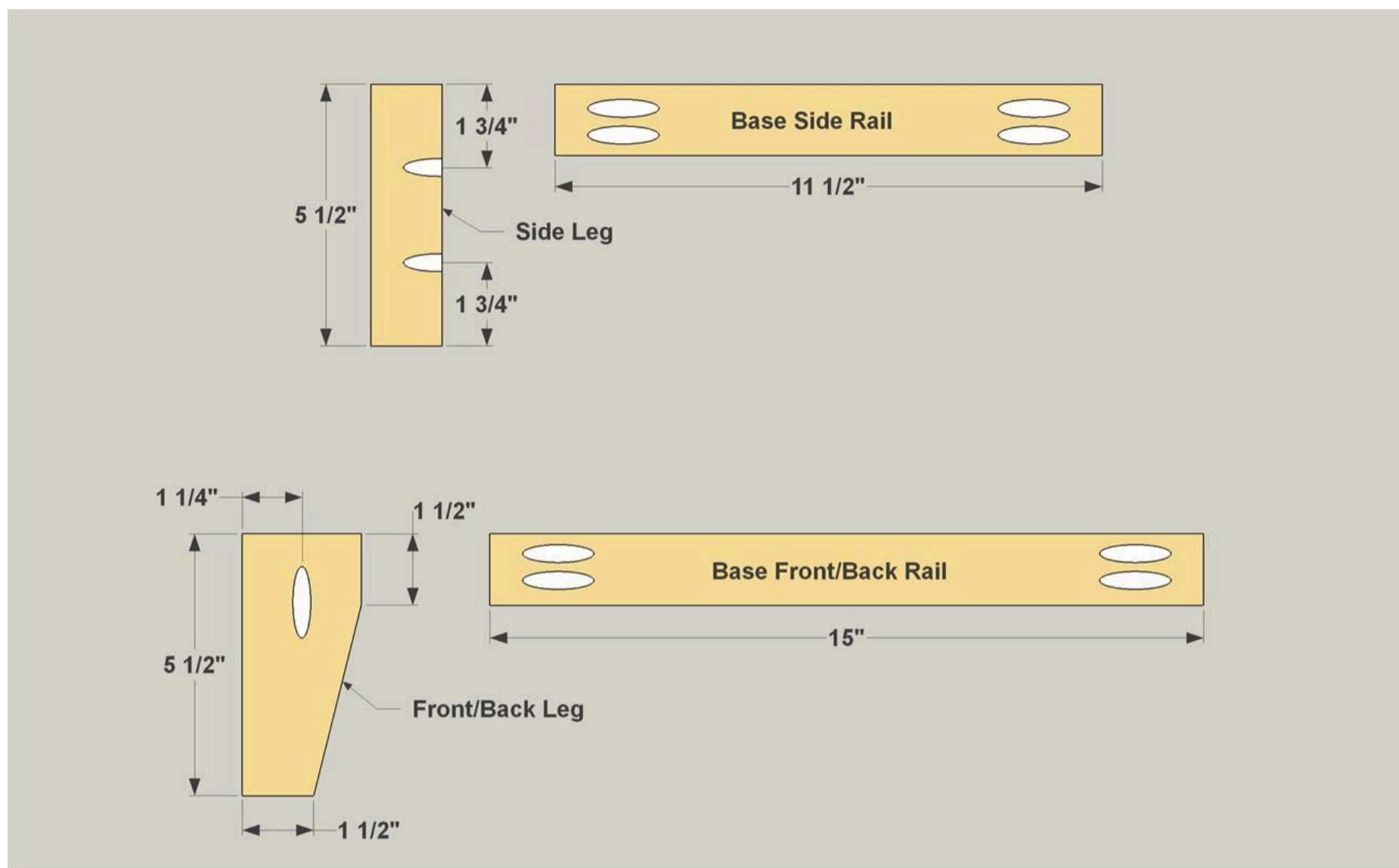

## 2

### Assemble the Base

Now you can assemble the base using 1 1/4" coarse-thread pocket hole screws, as shown.

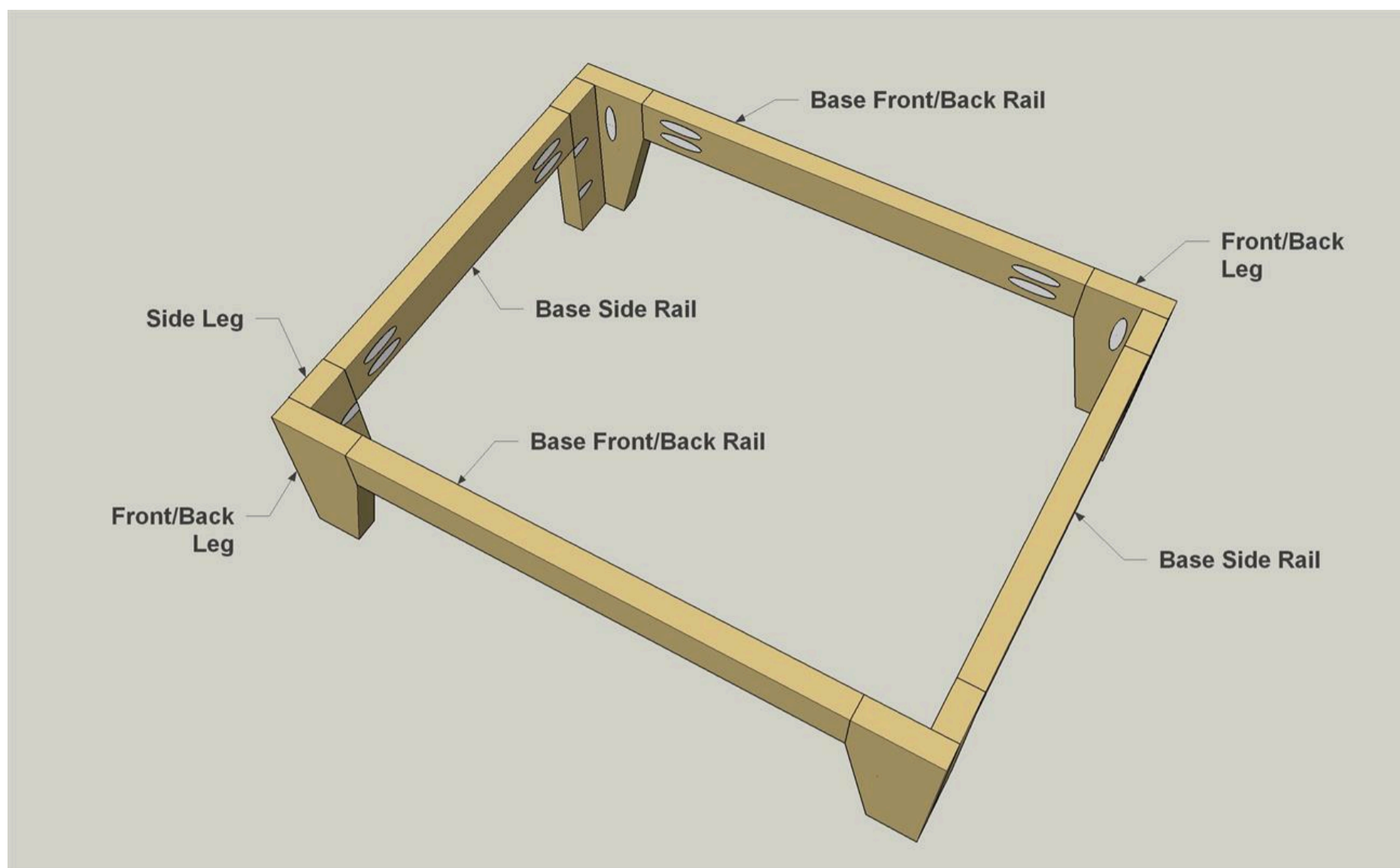

## 3

### Create the Bottom, Divider and Top

Cut a Bottom, Divider, and Top to size from 3/4" plywood (we used birch), as shown in the cutting diagram. Then, add iron-on edging to all edges of these pieces to cover up the exposed plywood.

**4****Attach the Bottom**

With the plywood edging complete, you can now attach the Bottom to the base assembly, as shown. Note that the Bottom overhangs 1/2" on all sides.

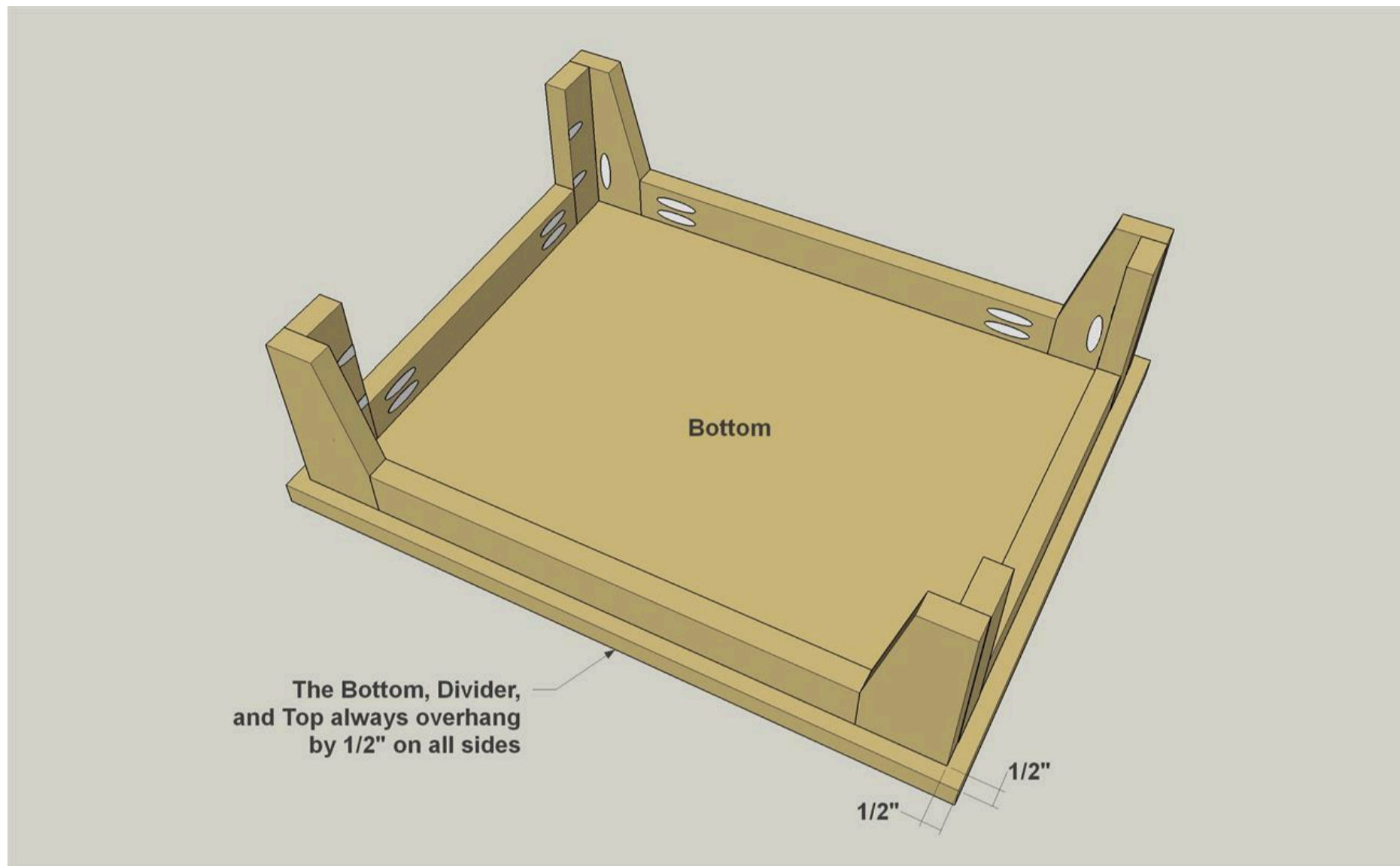



**5****Make the Lower Sides**

Cut two Lower Sides to size from 3/4" plywood, as shown in the cutting diagram. Also cut two Lower Front Stiles to length from 1x2 boards. Then, with your pocket-hole jig set up for 3/4" stock, drill pocket holes where shown in Lower Sides.

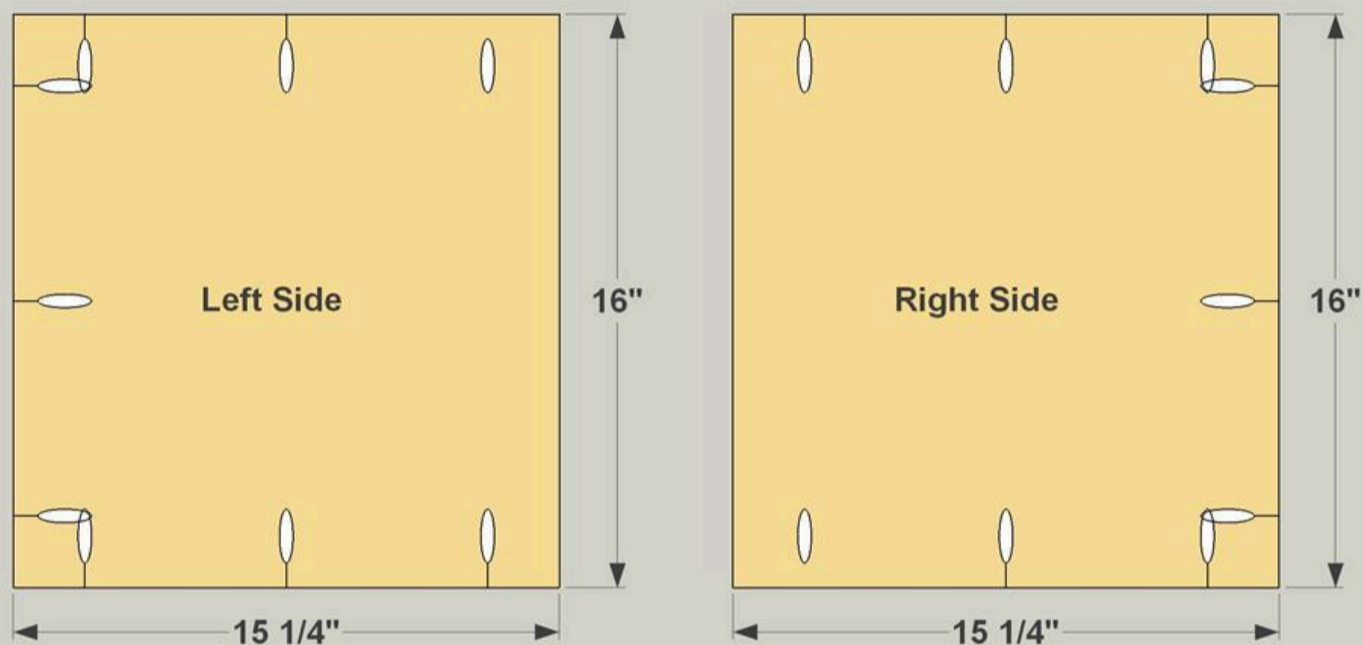

**6****Assemble the Lower Sides**

Now attach the Lower Front Stiles to the Lower Sides using 1 1/4" coarse-thread pocket hole screws. Make sure you are creating two "mirror image" assemblies, as shown.

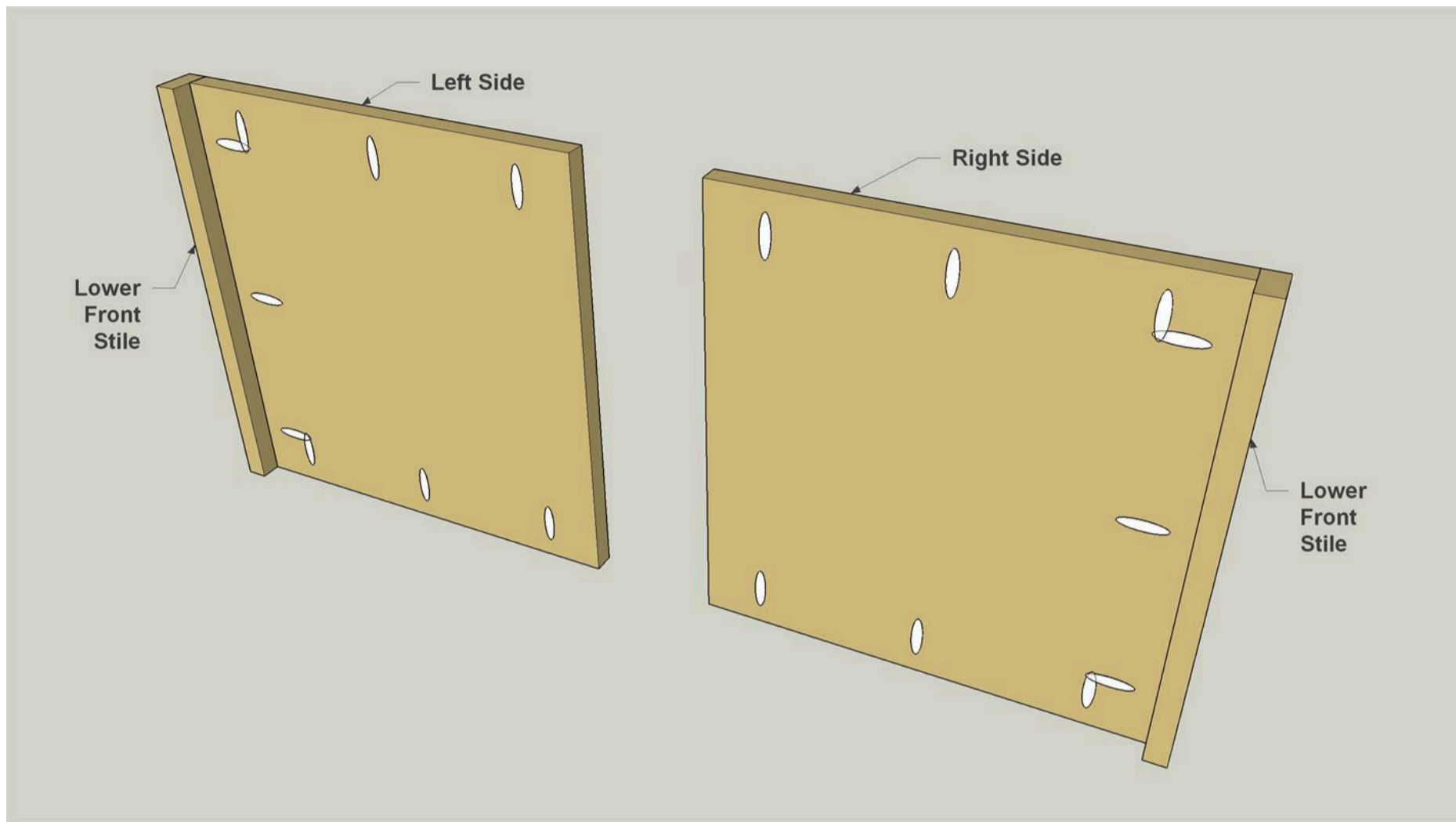

**7****Make the Backs**

Cut a Lower Back and an Upper Back to size from 3/4" plywood, as shown in the cutting diagram. With your pocket-hole jig set up for 3/4" stock, drill pocket holes where shown in the Backs.

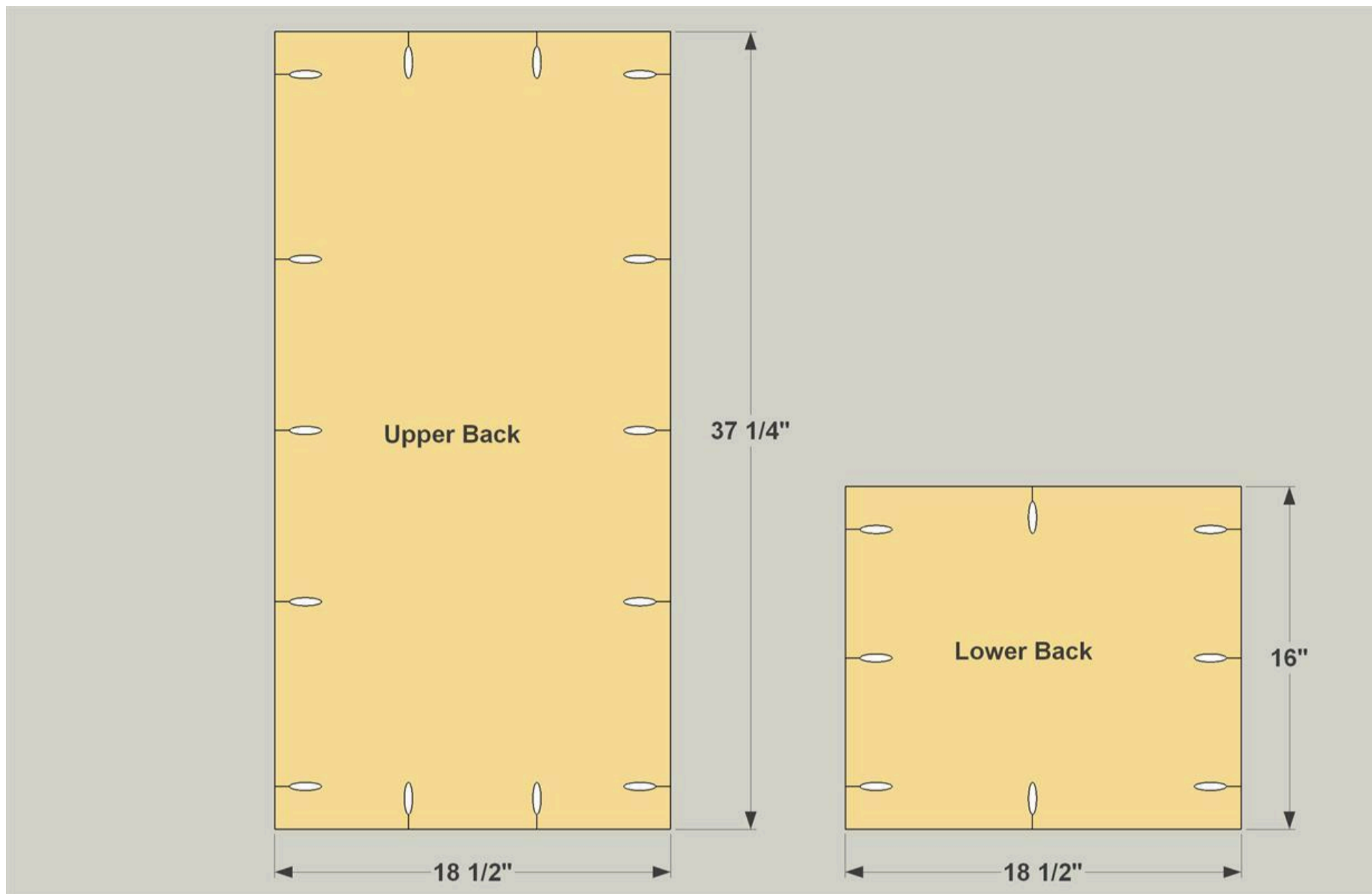

**8****Assemble the Lower Cabinet**

You can assemble the lower portion of the cabinet now by attaching the Back, Divider, and side assemblies to the base assembly using 1 1/4" coarse-thread pocket hole screws.

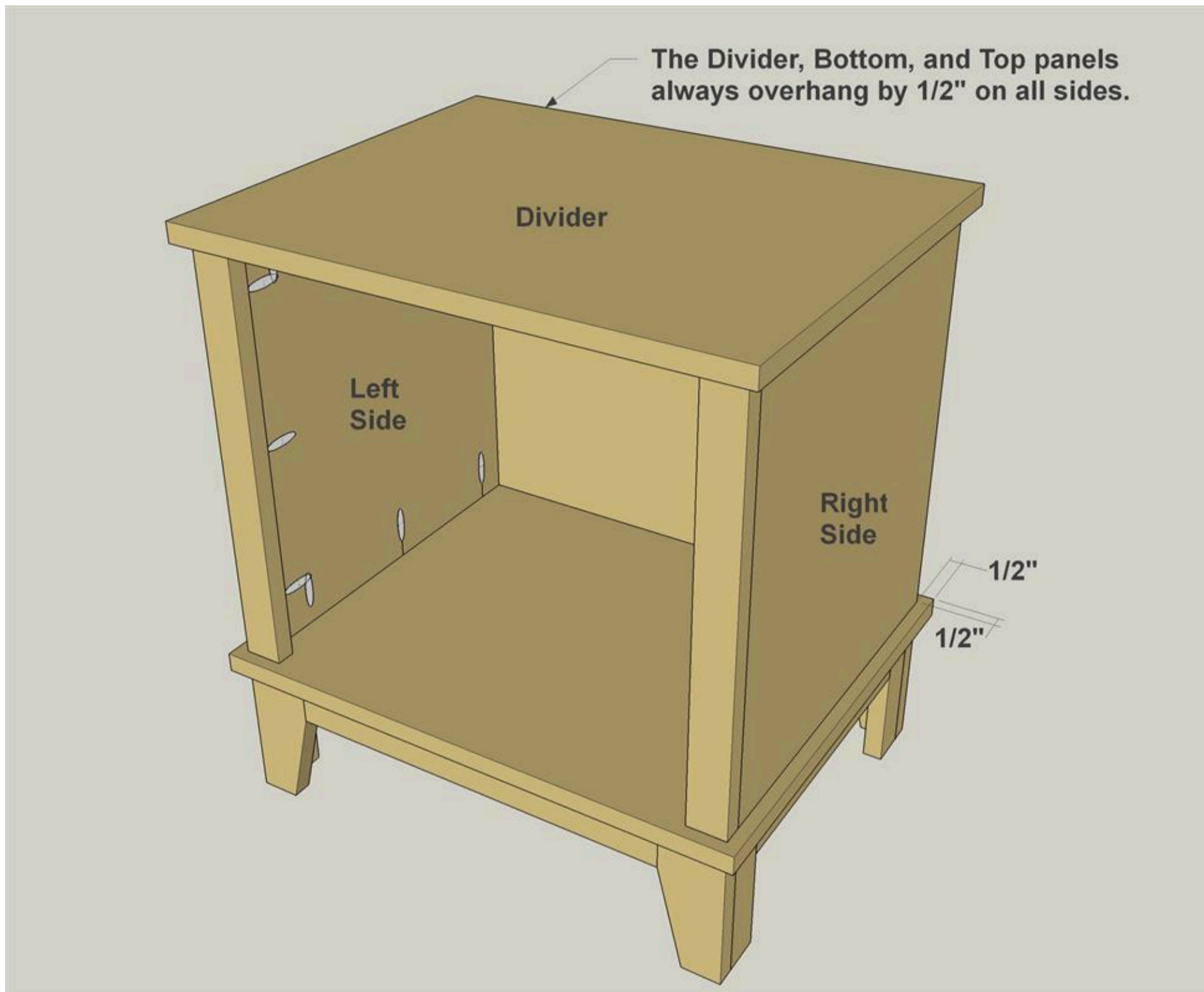

## 9

### Make Upper Front Stiles

Cut two Upper Front Stiles to length from 1x2 boards, as shown in the cutting diagram. With your pocket-hole jig set up for 3/4" stock, drill pocket holes where shown in the ends of these pieces.

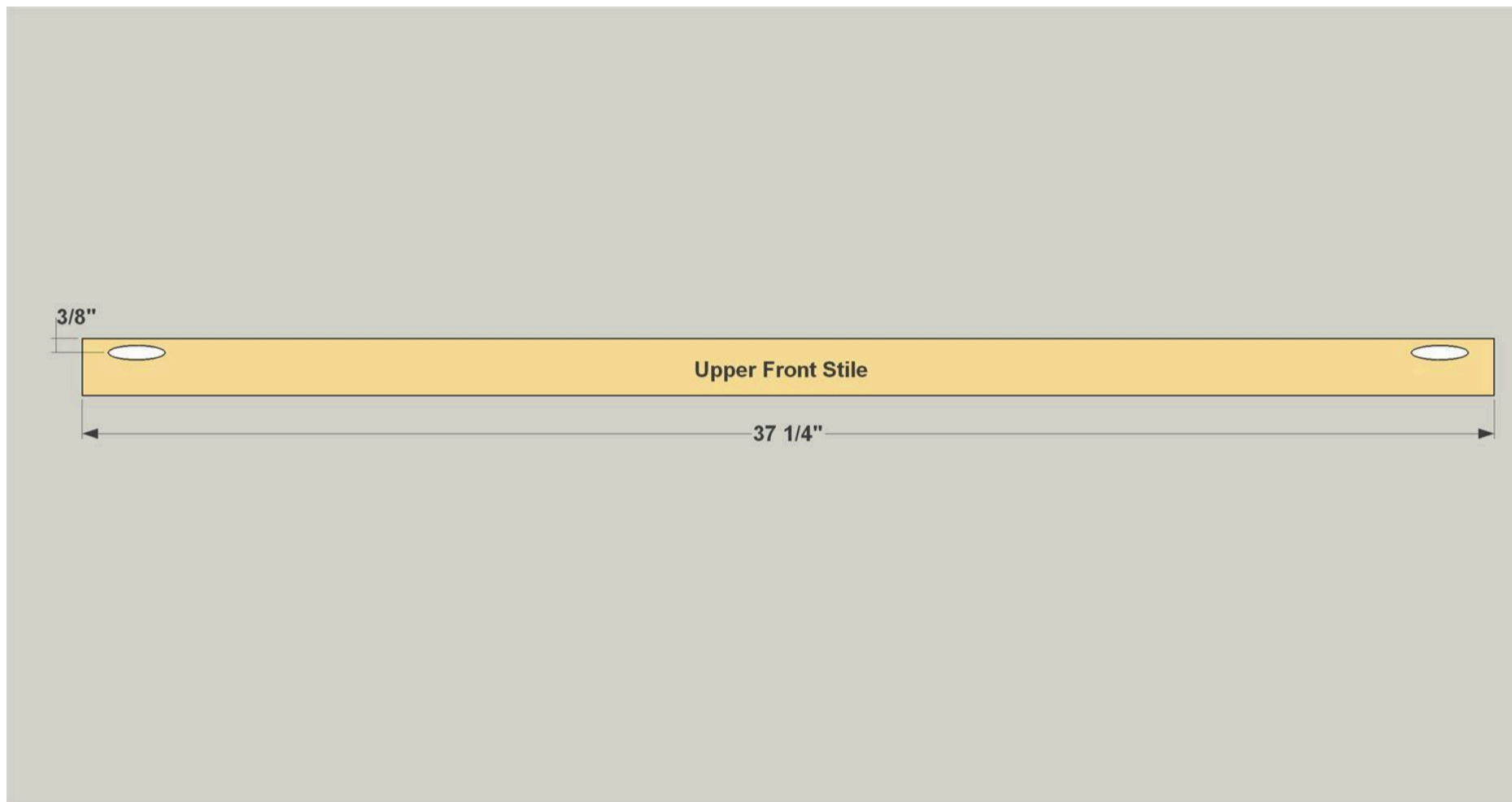

## 10

### Make the Upper Side Parts

Cut four Upper Side Stiles and four Upper Side Rails to length from 1x2 boards, as shown in the cutting diagram. With your pocket-hole jig set up for 3/4" stock, drill pocket holes in the Upper Side Rails. It's important that you offset these holes toward one edge, as shown, to leave space for a rabbet you'll rout later.

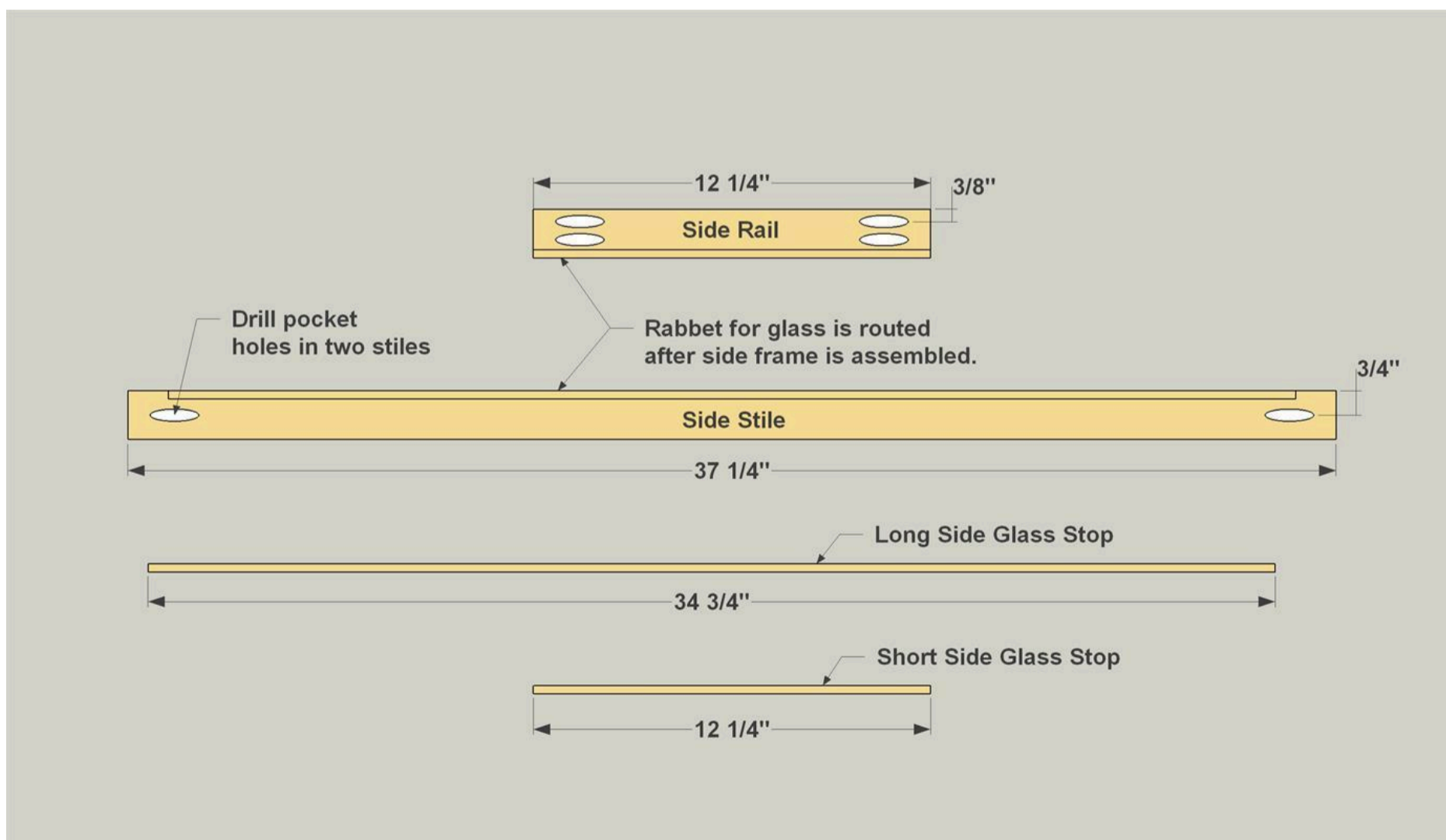

**11****Assemble the Upper Sides**

Now you can assemble the upper side frames, as shown, using 1 1/4" coarse-thread pocket hole screws. Make sure as you attach the Stiles that the pocket holes are offset to the outside, as shown. Then you can create the recess around the inside, called a rabbet, for the glass to fit into. You do this with a router and a rabbeting bit. This bit has a bearing that rides along the wood to ensure a consistent cut. Be sure the bit will create a 1/4"-wide rabbet, and cut the rabbet 3/8" deep. See the Tip for more information.

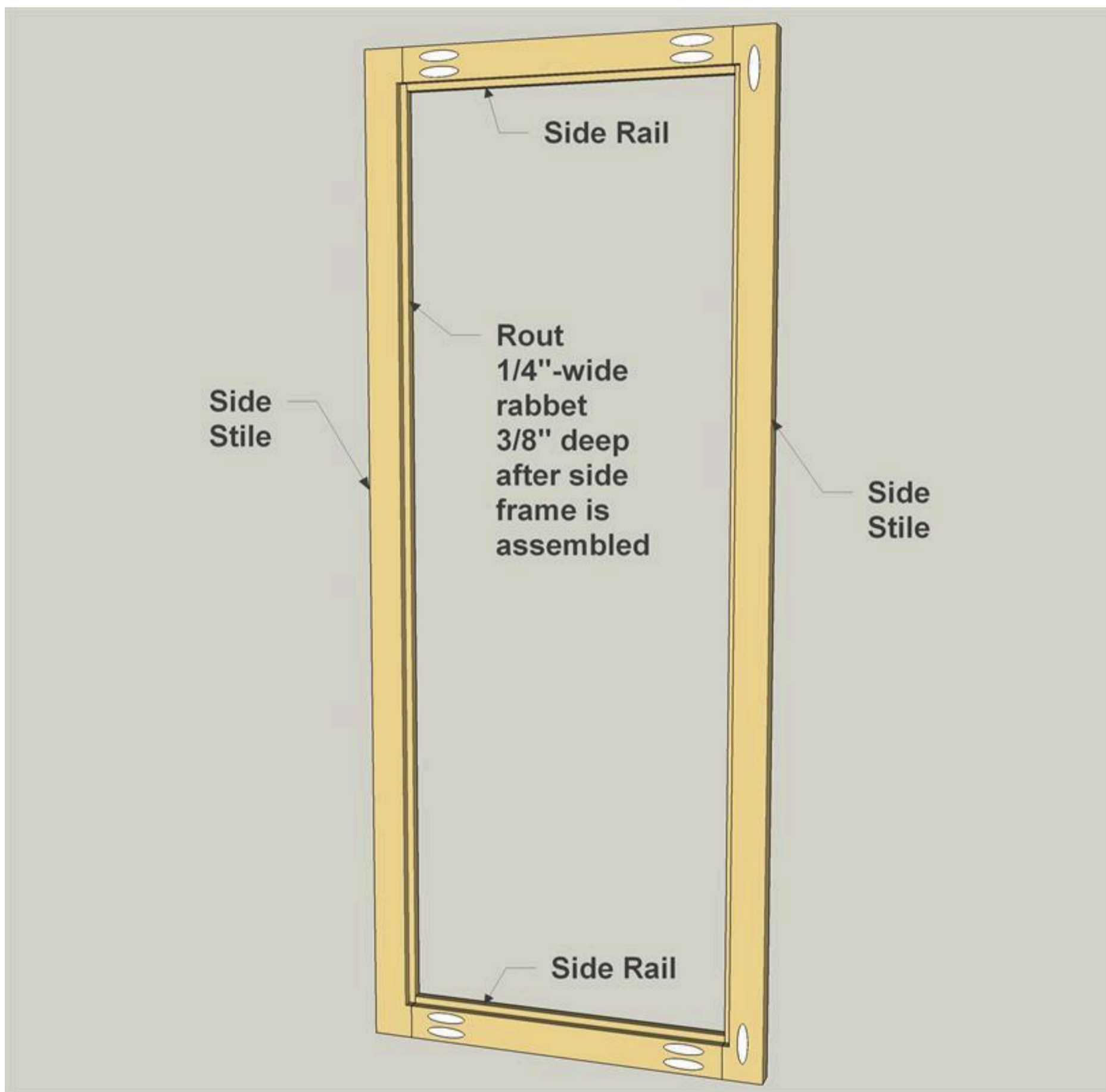

**12****Assemble the Upper Cabinet**

You can assemble the upper portion of the cabinet. To do this, start by attaching the Upper Back, the side frame assemblies, and the Top using 1 1/4" coarse-thread pocket hole screws. Then you can add the Upper Front Stiles. In addition to being attached to the Top and Divider with pocket hole screws, the Upper Front Stiles need to be glued to the side frames. You can use clamps to hold the stiles tight to the frames while the glue dries, or wrap masking tape tightly around in several spots.

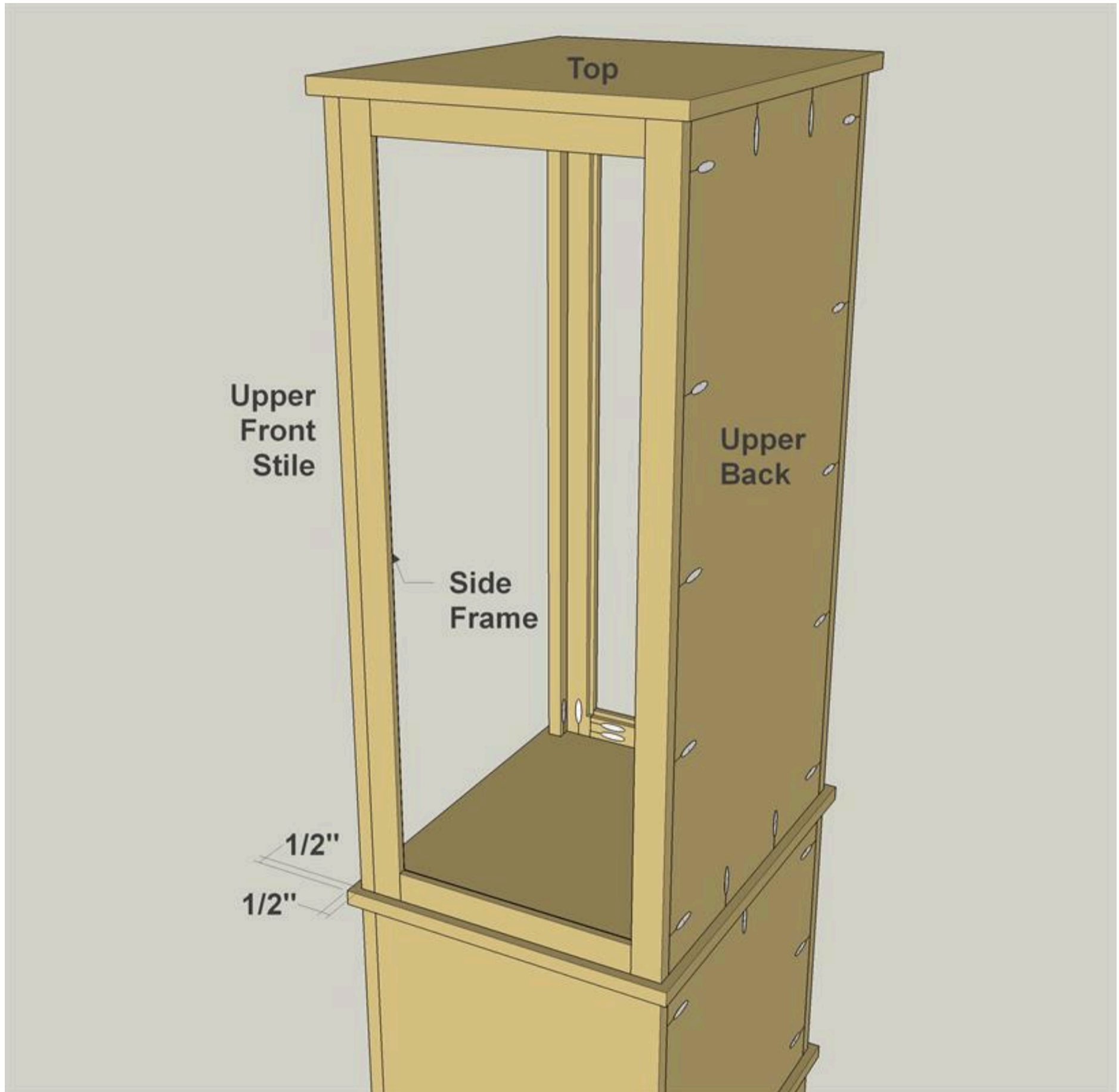

**13****Test-Fit the Glass and Stops**

This is a good time to cut Long and Short Side Glass Stops to fit, and to test fit them, along with the glass. You probably don't want to glue the stops in place now, though. It's easier to paint or stain everything first, and then add the glass.

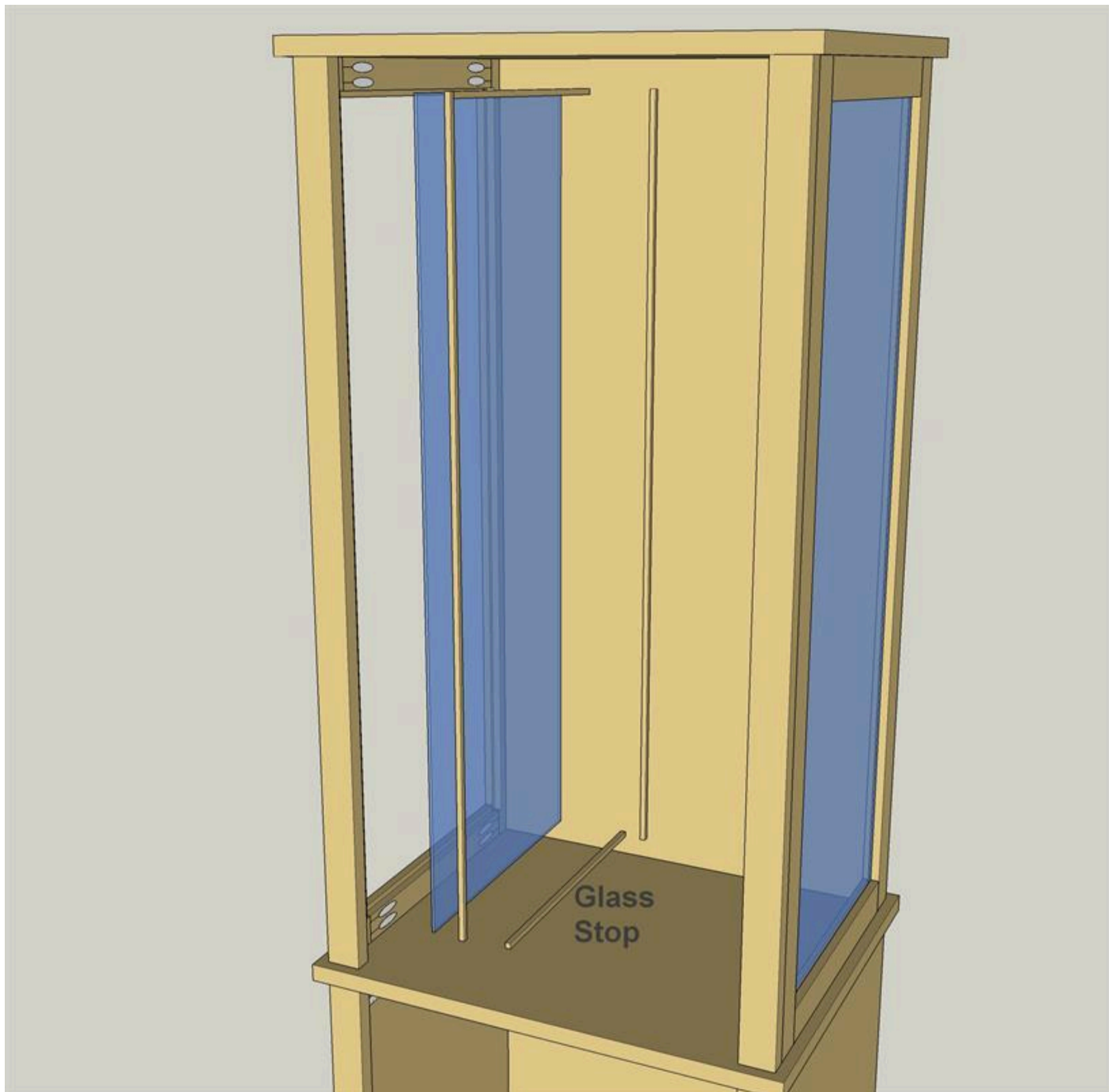



## 14

**Make the Upper Door Parts**

Cut two Upper Door Stiles and two Upper Door Rails to length from 1x2 boards, as shown in the cutting diagram. With your pocket-hole jig set up for 3/4" stock, drill pocket holes in the Upper Side Rails. It's important that you offset these holes toward one edge, just as you did with the upper side pieces.

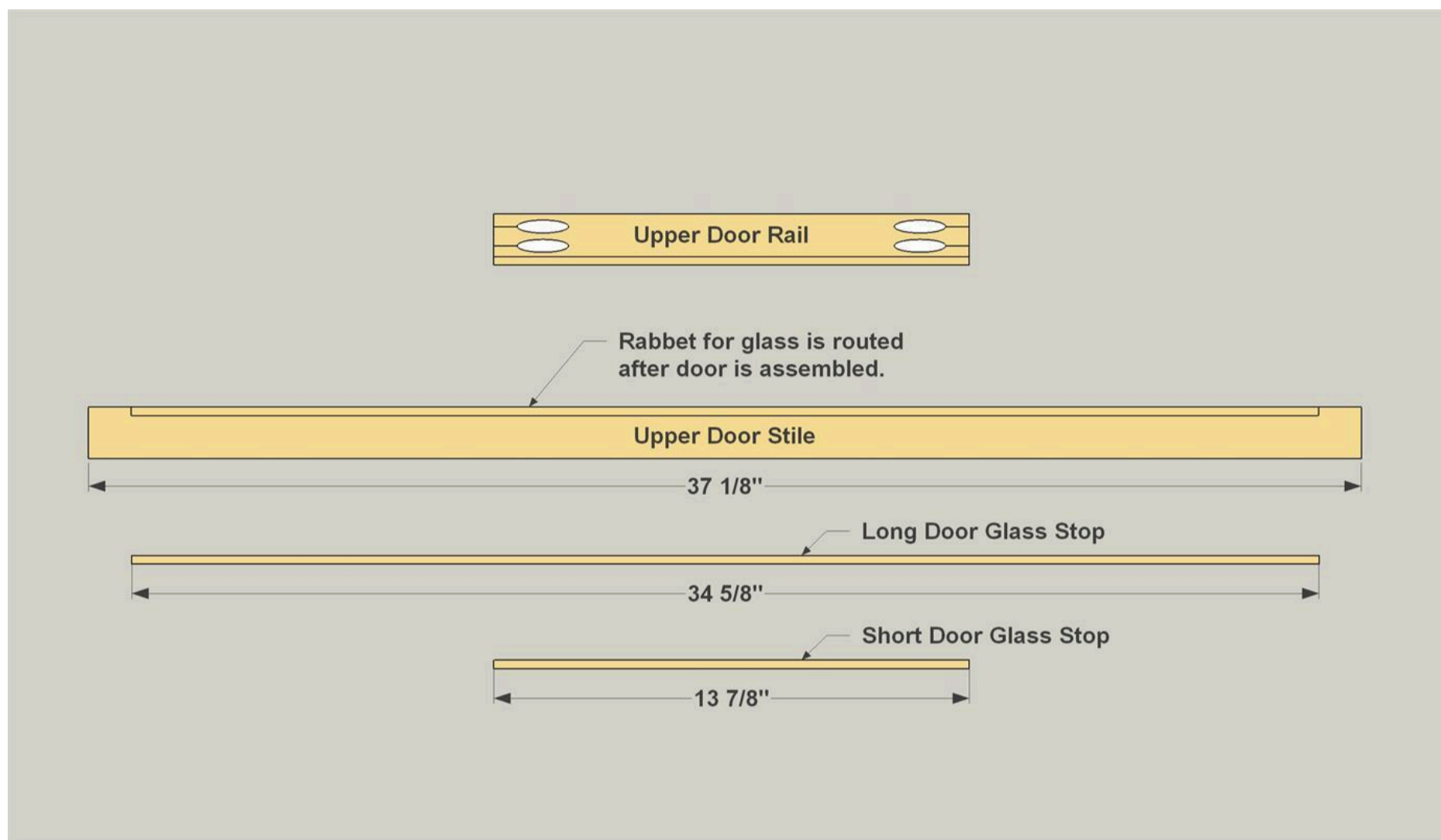

**15****Assemble the Upper Door**

Now you can assemble the upper door, as shown, using 1 1/4" coarse-thread pocket hole screws. Make sure as you attach the Stiles that the pocket holes are offset to the outside, as shown. Then you can create the rabbet for the glass, just as you did on the side frames.

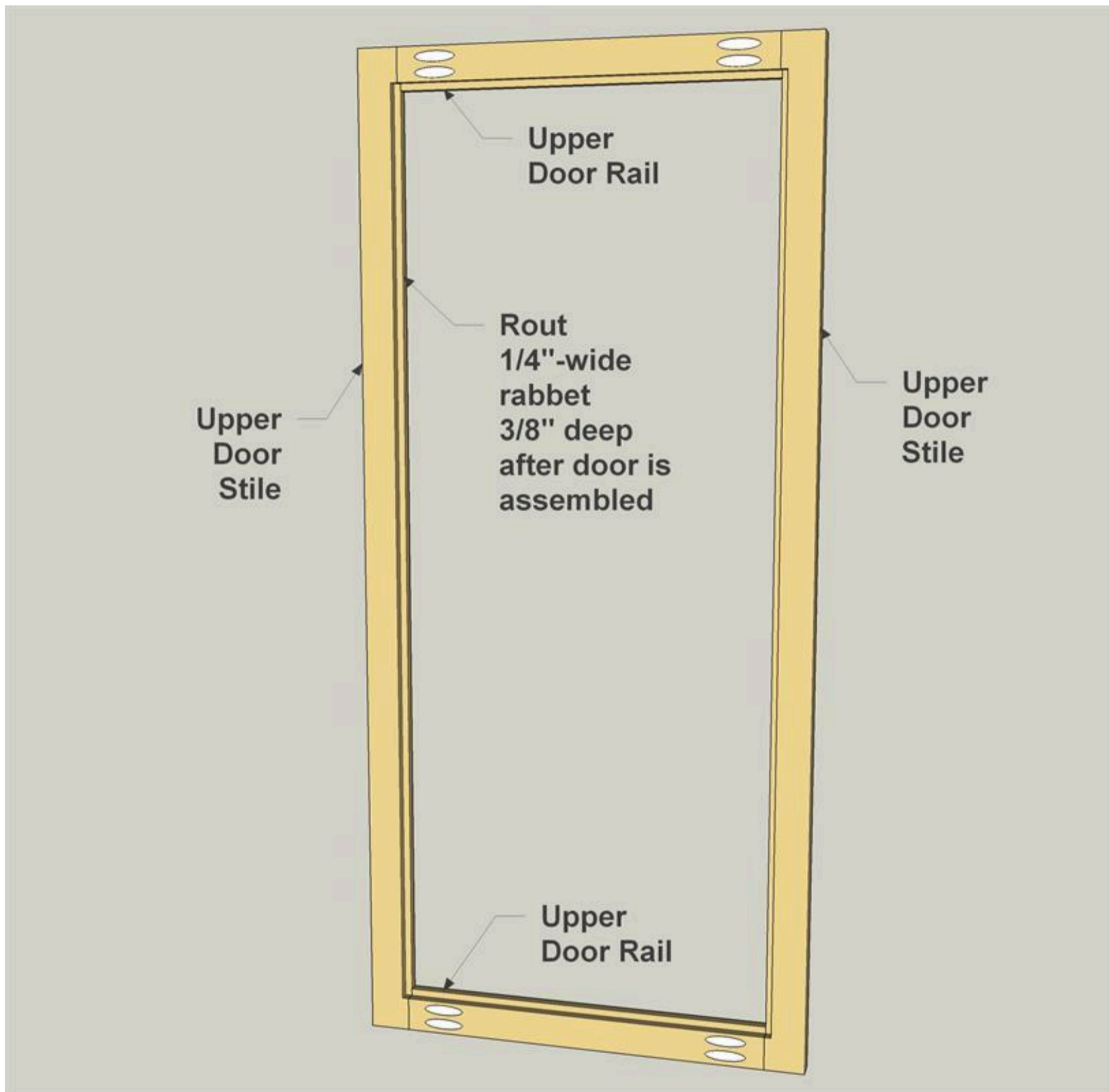

16

**Test-Fit the Door Glass and Stops**

Again, this is a good time to cut Long and Short Door Glass Stops to fit, and to test fit them, along with the glass, as you did with the sides.



**17****Make the Lower Door Parts**

Cut two Lower Door Stiles and two Lower Door Rails to length from 1x2 boards, as shown in the cutting diagram. Also cut a Lower Door Panel to size from 1/2" plywood, as shown in the cutting diagram. With your pocket-hole jig set up for 3/4" stock, drill pocket holes in the Lower Door Rails, as shown. Change your jig setup to 1/2" stock, and then drill pocket holes in the Lower Door Panel.

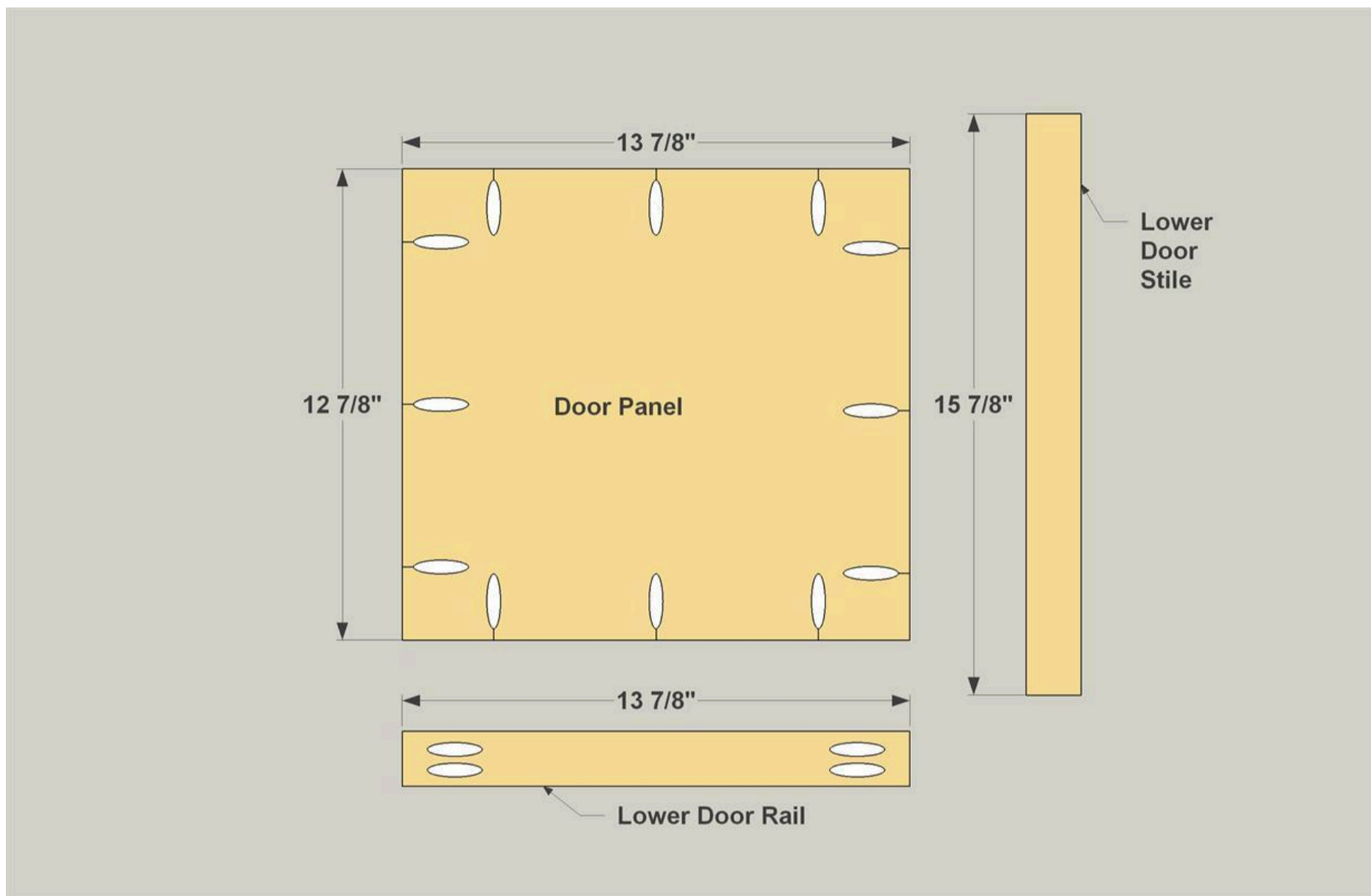

**18****Assemble the Lower Door**

Now you can assemble the lower door, as shown. Use 1 1/4" coarse-thread pocket hole screws to assemble the Stiles and Rails. For the panel, make sure it's flush with the back faces of the rails, and then attach it using 1" coarse-thread pocket hole screws.

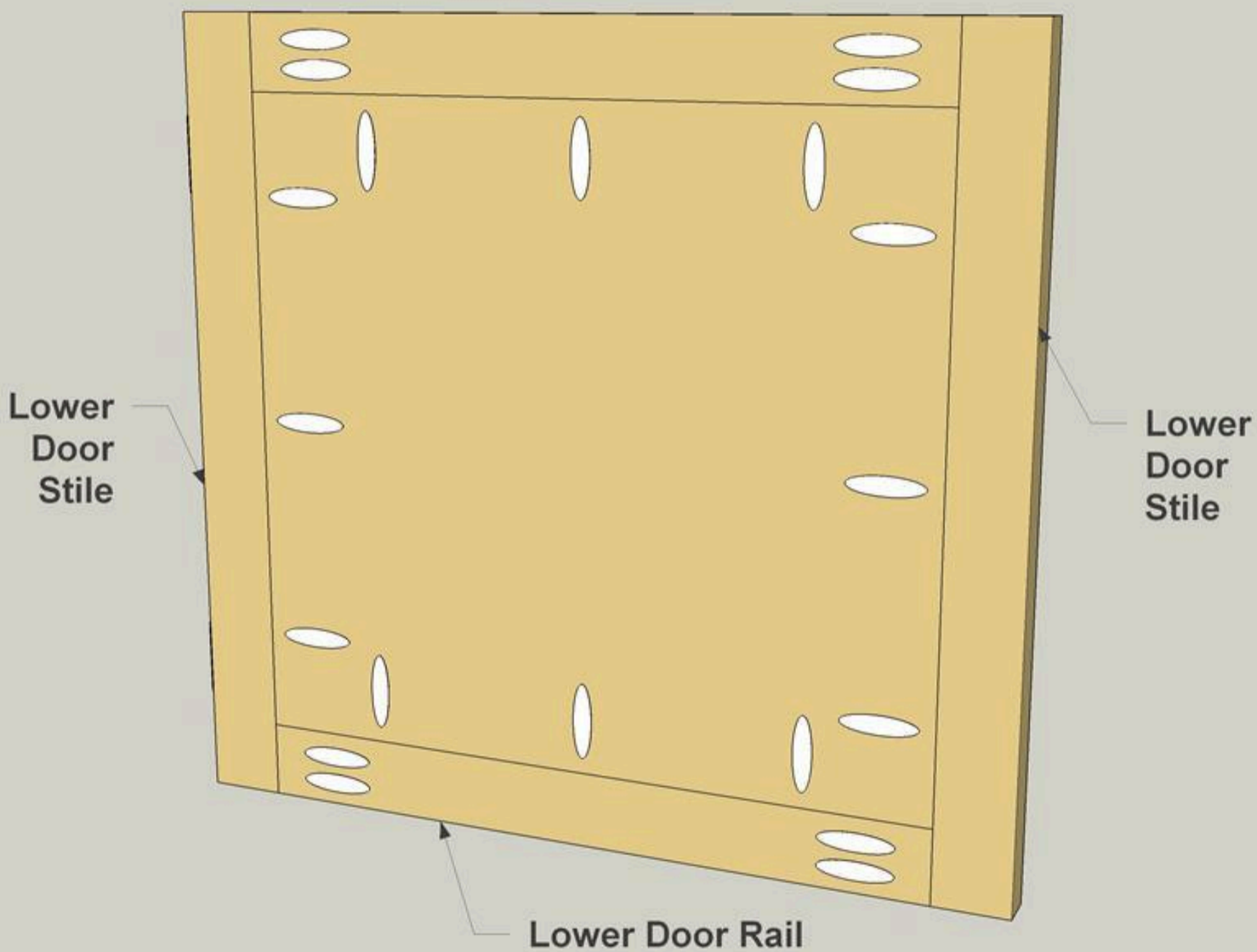

**19****Make the Shelves**

Cut two Shelves to size from 1/2" plywood, as shown in the cutting diagram. Then, with your jig set for 1/2" stock, drill pocket holes in the Shelves, as shown.

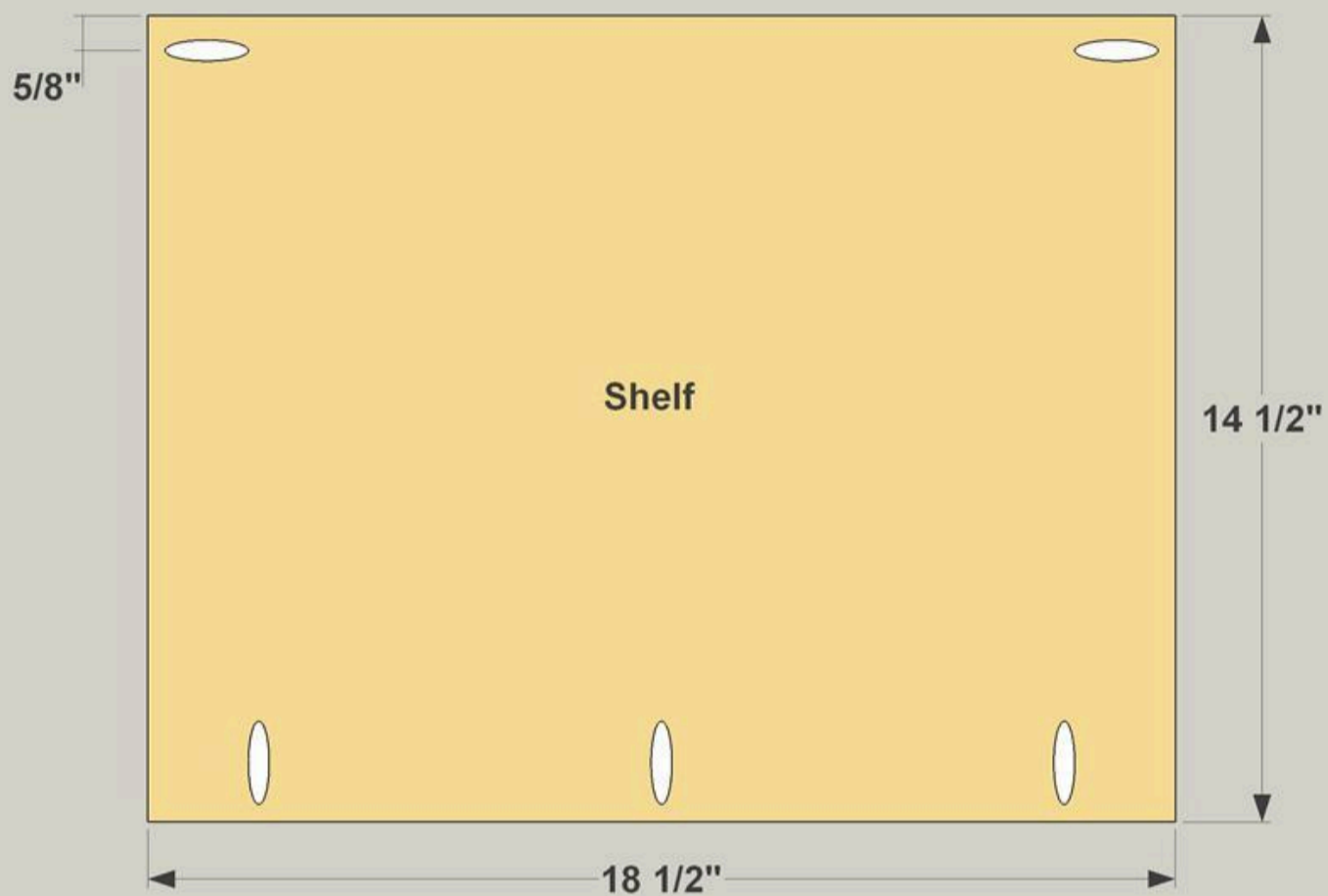

20

### Finish, Install Glass and Shelves

With all the parts complete, this is a good time to paint or finish the cabinet. Be sure to do the glass stops, as well. Then you can put the glass in place and glue in the Glass Stops. After that, the shelves can go in and get attached with 1" coarse-thread pocket hole screws.

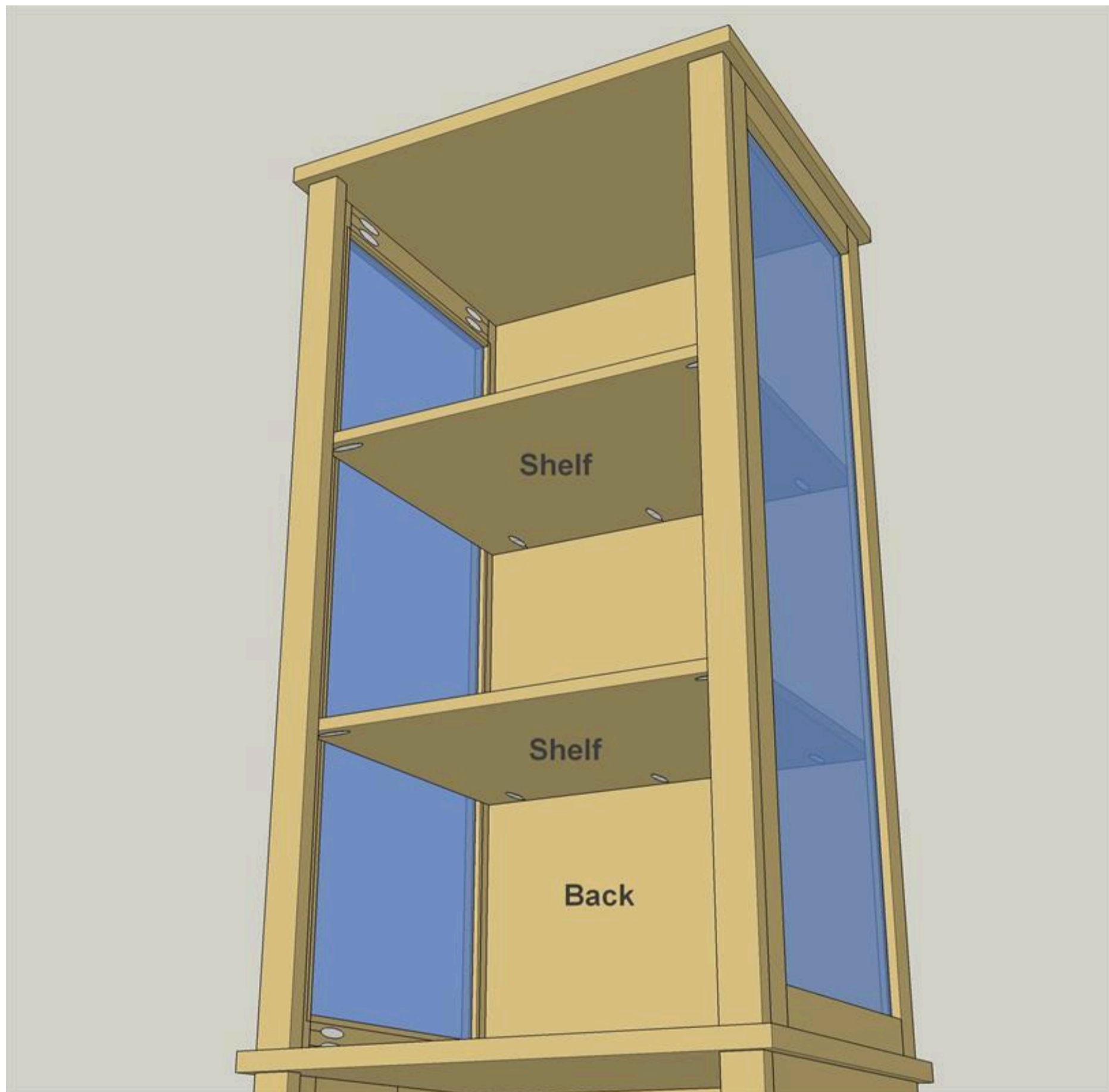

**21****Hang the Doors**

All that's left to complete your cabinet is installing the doors. Install them using no-mortise hinges. These make it a lot easier to install doors, since you don't have to recess (mortise) them into the wood. Add a couple of door pulls, and your cabinet is all set to go.

