

# Rustic Modern Side Table

By **Kreg Tool**

Difficulty

Easy

Storage is important, that's why these easy to build side tables are so great. They add just the right amount of storage for any space, and all you need are a couple boards and some stock legs from the home center. They're simple enough you can easily build a couple of them in just a weekend.

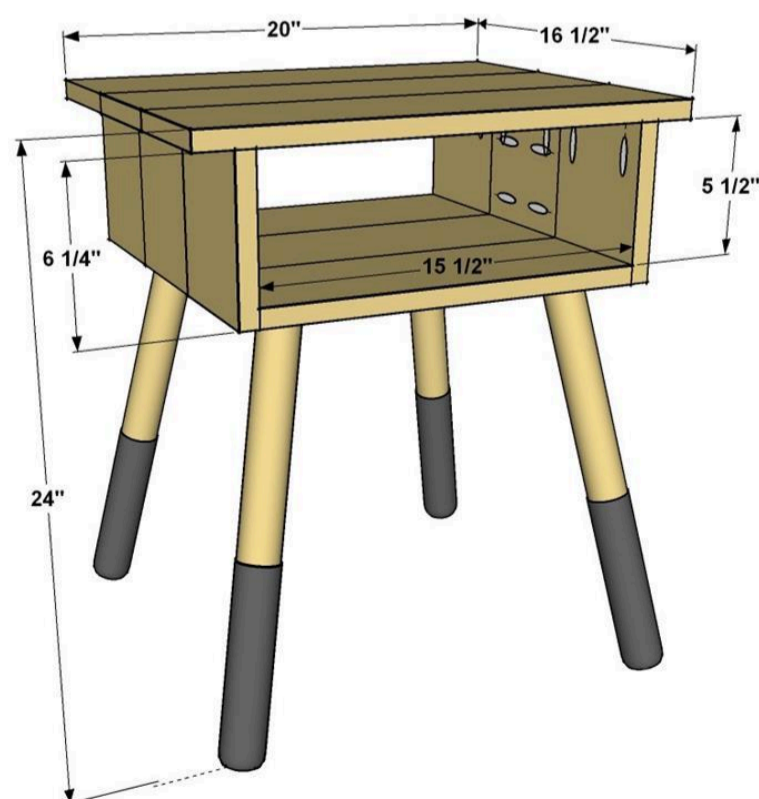
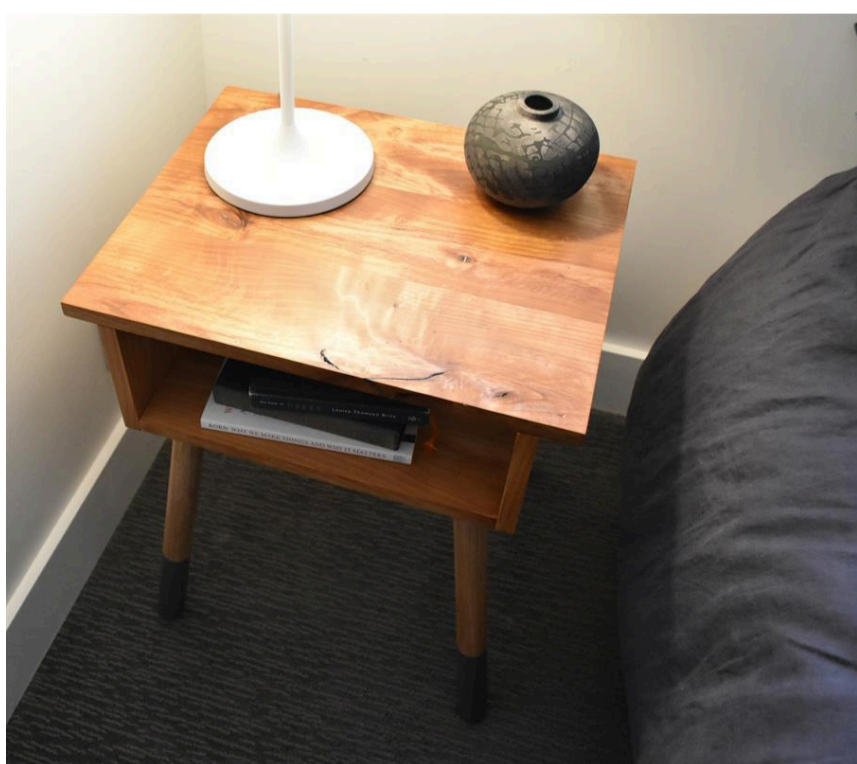

## Tools

### Other Tools

Miter Saw

Square

Tape Measure

Clamps

Drill (cordless)

Tape Measure

## Materials

### Wood Products

1 Board , 1x6 , 72"

1 Board , 1x6 , 96"

### Hardware & Supplies

1 Box - 1 1/4" Fine-thread Kreg Pocket-hole Screws (42 Screws Needed)

4 17" Ash Table Legs

4 Metal Table Leg Angle Top Plates

1 Wood Glue

1 Self-Centering Drill Bits

# Cut List & Parts

- 3 Top,  $\frac{3}{4}$ " X  $5\frac{1}{2}$ " X 20" Alder
- 3 Shelf,  $\frac{3}{4}$ " X  $5\frac{1}{2}$ " X  $15\frac{1}{2}$ " Alder
- 6 Side,  $\frac{3}{4}$ " X  $5\frac{1}{2}$ " X  $6\frac{1}{4}$ " Alder

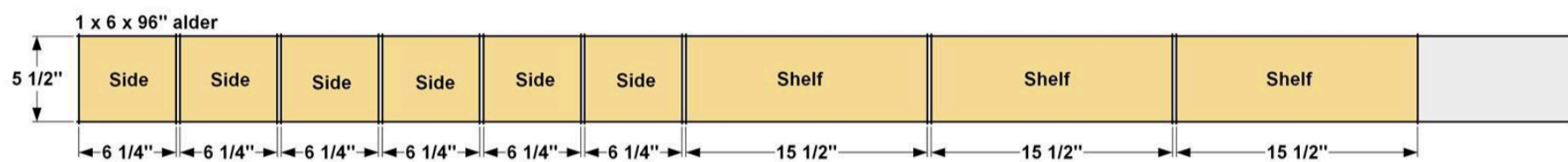
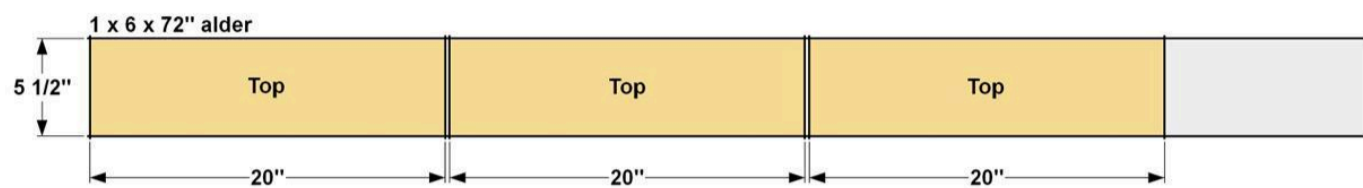

# Directions

1

## Cut the Top Boards

Start by cutting all of the Top boards to finished size from a 1 x 6 alder board, as shown in the cutting diagram. Set your Kreg Pocket-Hole Jig for 3/4"-thick material, and then drill pocket holes in one of the Top boards at the locations shown.

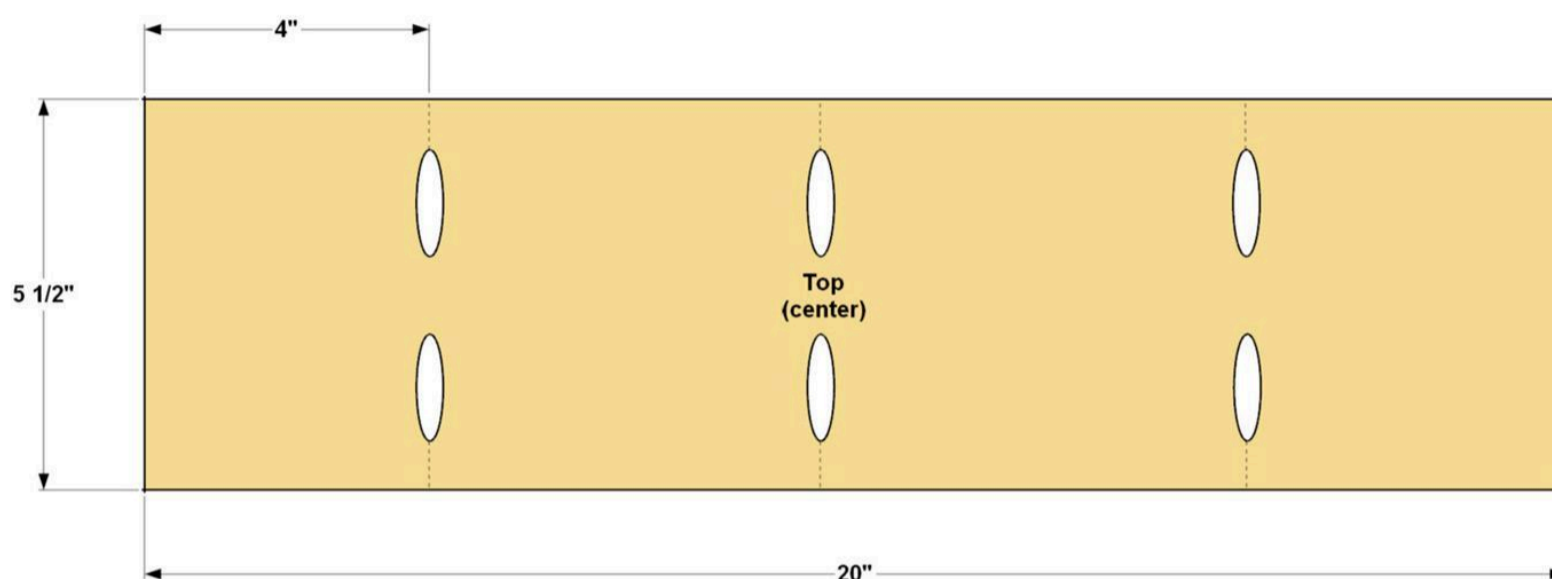

2

## Assemble the Top

Apply glue to the mating edges of the Top boards and align them to form the top. Clamp the boards together and then secure them with 1 1/4" fine-thread Kreg screws.

### 3

#### Cut the Side Boards

Cut six Side boards to finished size from a 1 x 6, as shown in the cutting diagram. Drill pocket holes in each board, at the locations shown.

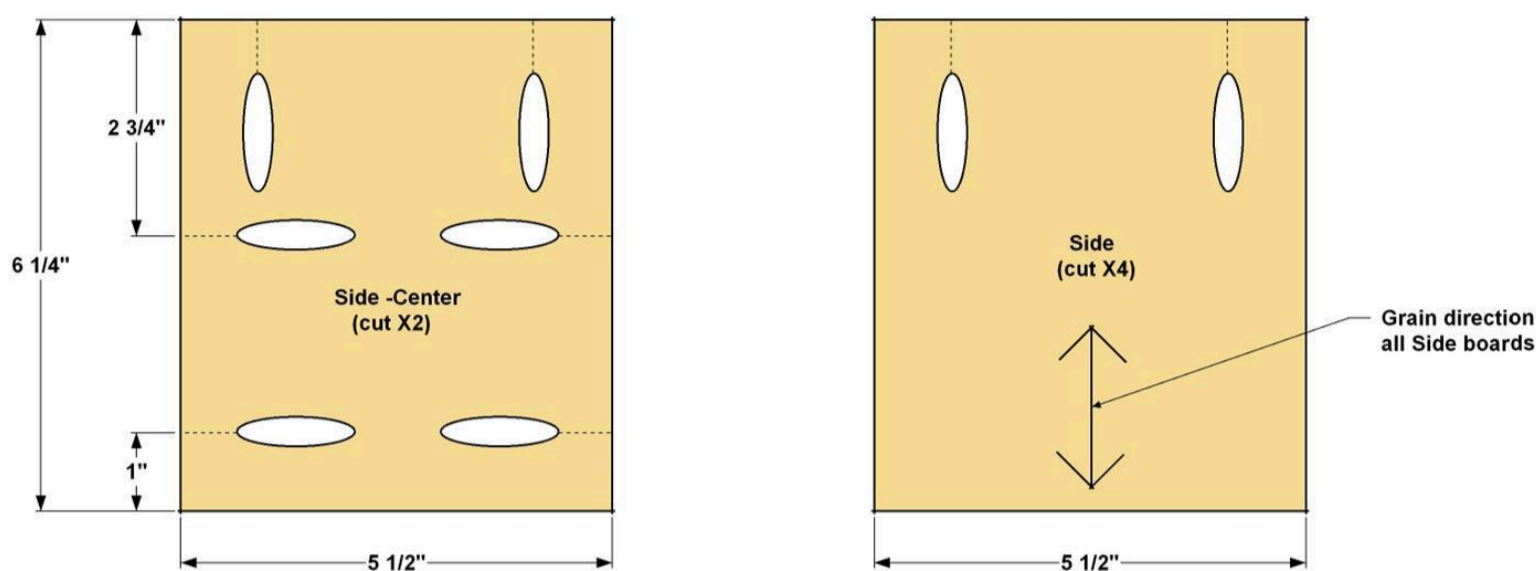

### 4

#### Assemble the Sides

Apply glue to the mating edges of the three Side boards and align them to form a Side panel, as shown. Clamp the boards together and then secure them with 1 1/4" fine-thread Kreg screws. Repeat this process for the other Side.

Sand both sides of each panel with 120 grit sand paper first, and then finish with 150 or 180 grit for the final surface.

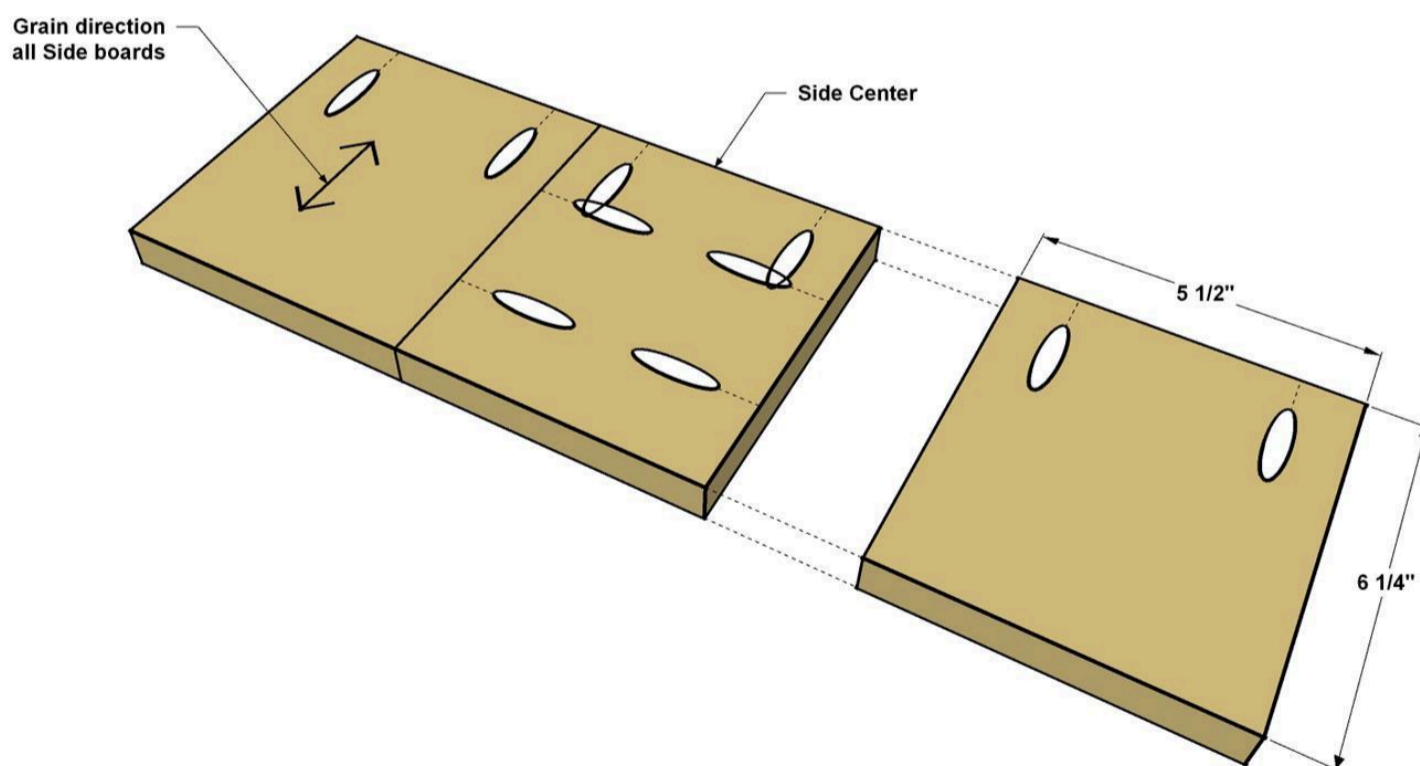



## 5

### Cut the Shelf Boards

Cut three Shelf boards to finished size from a 1 x 6 alder, as shown in the cutting diagram. Drill pocket holes in all the boards at the locations shown.

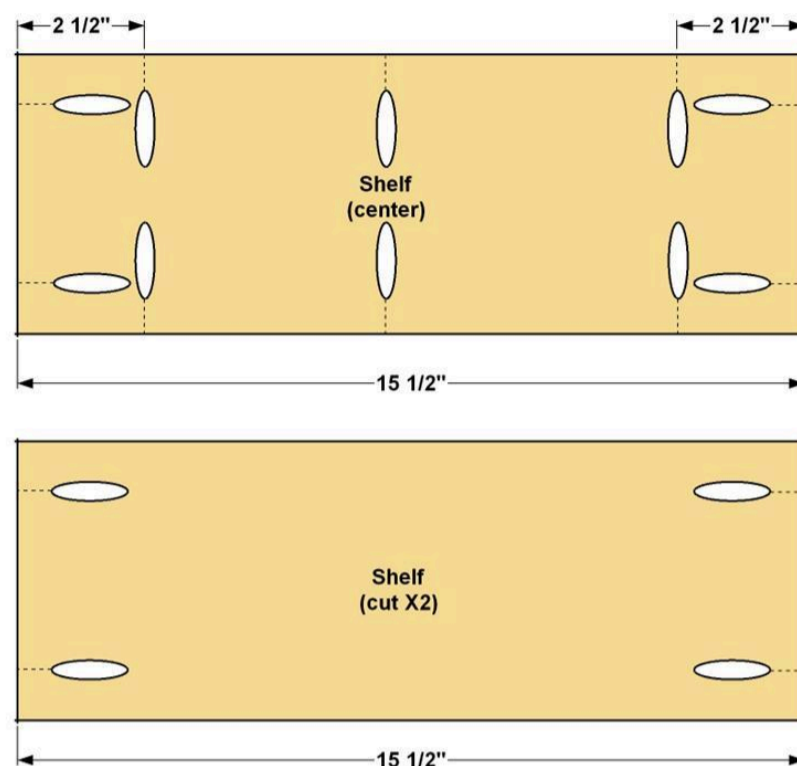

## 6

### Assemble the Shelf

Apply glue to the mating edges of three Shelf boards and align them to form a Shelf panel, as shown. Clamp the boards together and then secure them with 1 1/4" fine-thread Kreg screws.

Sand both sides of the panel with 120 grit sand paper first, and then finish with 150 or 180 grit for the final surface.

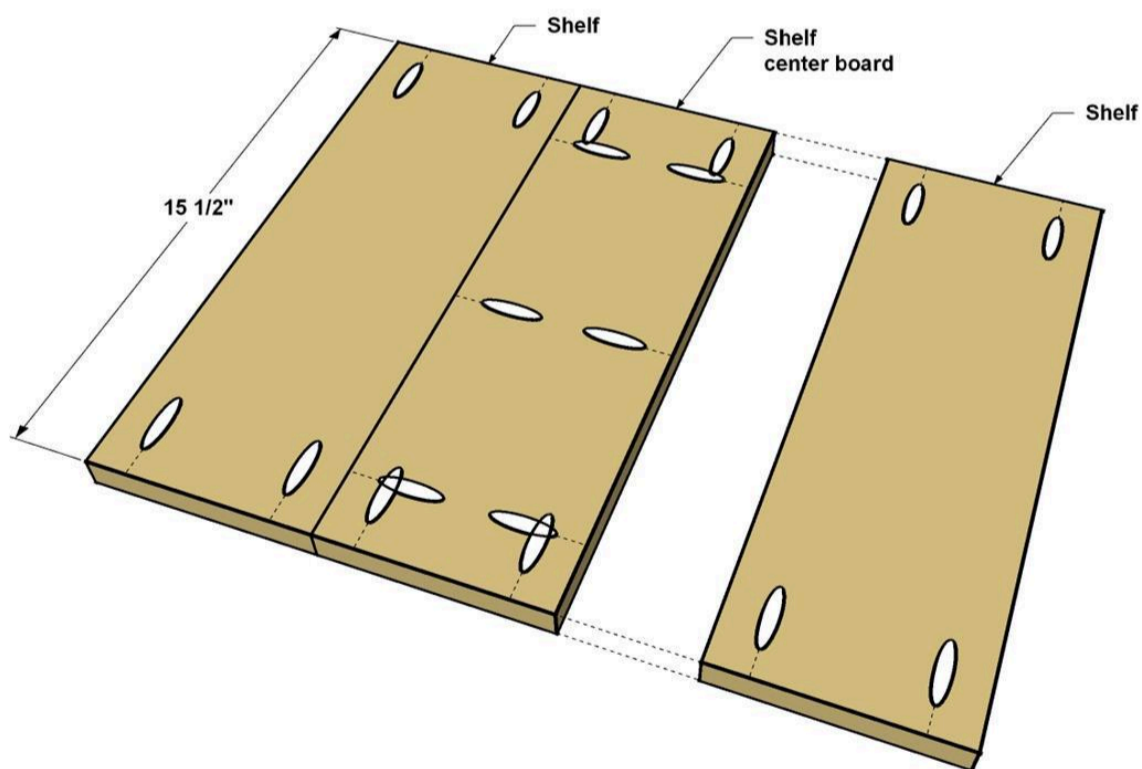



## 9

### Finish the Table

Sand all the parts smooth and wipe away dust with a rag. Apply the finish of your choice. We finished our Side Tables with a natural oil to highlight the alder wood we used. For a little extra protection, you can add a couple thin coats of paste wax after the oil has had time to dry. Follow the manufacturer's recommendations for proper drying time and application process.

## 10

### Add the Leg Brackets

Position the first leg bracket at a 45° angle to the corners of the table, where shown. Using the bracket screw holes and a self-centering drill bit, drill pilot holes for the first bracket. Secure the bracket to the Side Table with the screws provided. Repeat this process for the other three brackets.

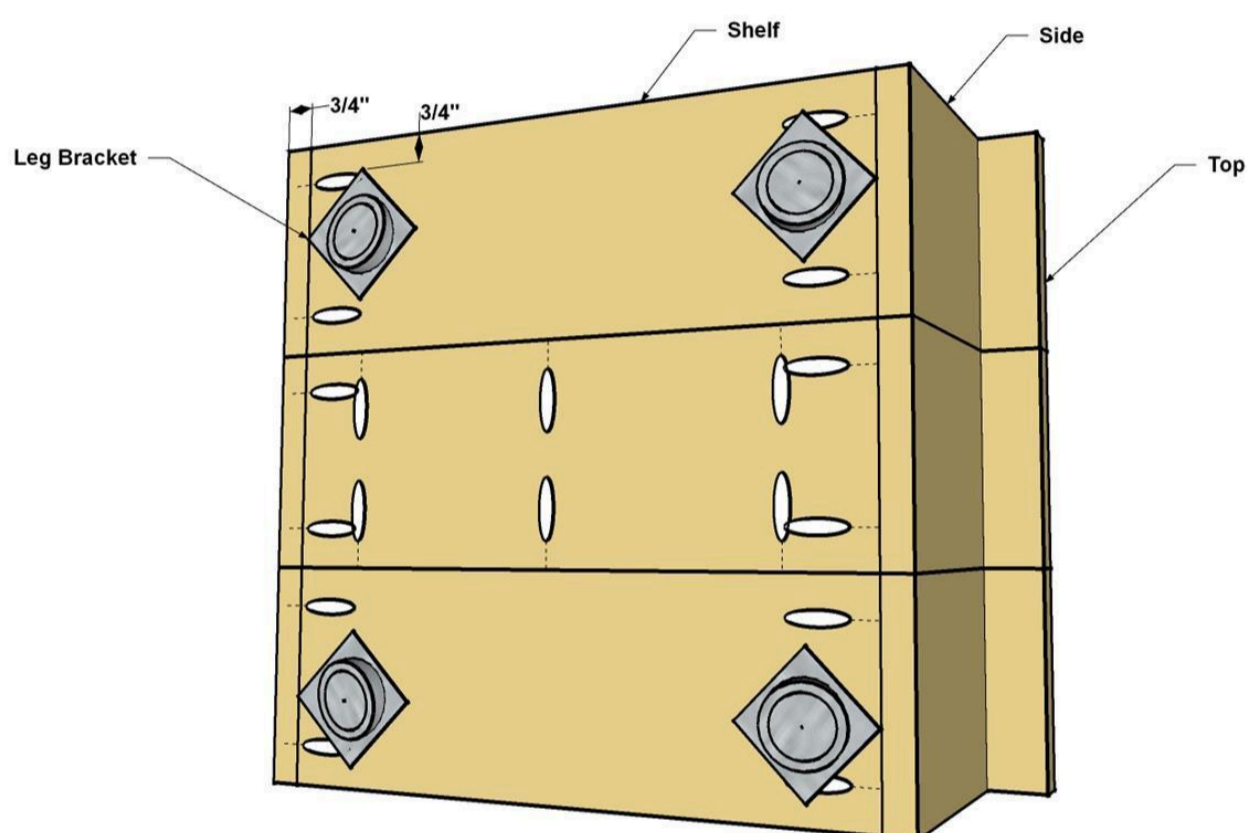



**11****Paint, Finish, and Attach the Legs**

Finally, to achieve the dipped leg look, mask off the bottom 6" or so of each leg with a quality painters' tape. Here's a little tip to support the legs while you paint them: Using a scrap piece of wood about 3' long, drill four 1/4" holes spread out along the board. Next, screw the legs into the board. Now you can paint the legs with ease. Once the paint dries, you can apply a clear protective finish to the legs. This will enhance the natural color of the wood as well as help protect them.

When the finish is dry, screw the legs into the brackets until they are snug. Flip the table over and they will be ready to support a good nights sleep..as well as a lamp.

