

Modern Farmhouse Table

By **Kreg Tool**

Difficulty

Advanced

Simple, classic lines make this farmhouse table equally at home in traditional and contemporary homes. The table is also sturdy and offers room for six. It's built using standard dimensional lumber—we chose a hardwood called alder. Pocket-hole joinery keeps construction straightforward.

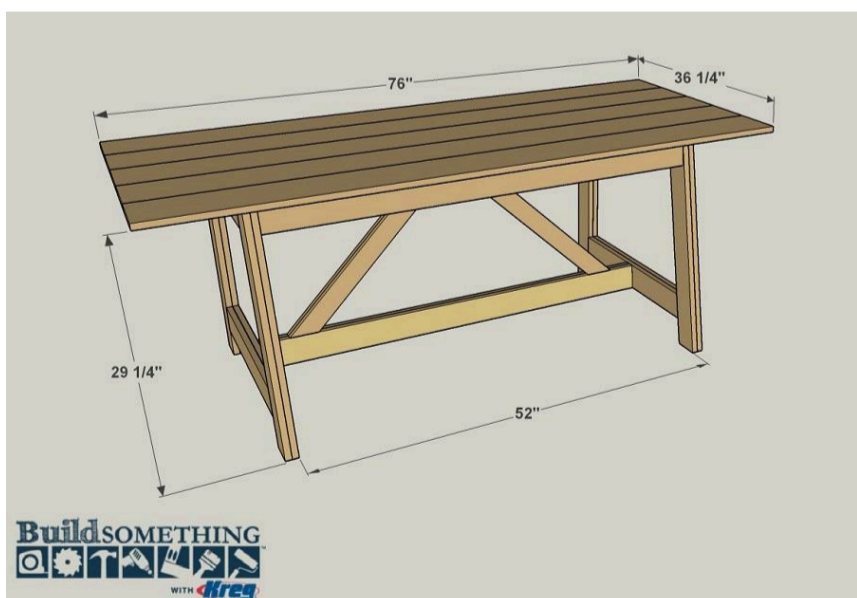
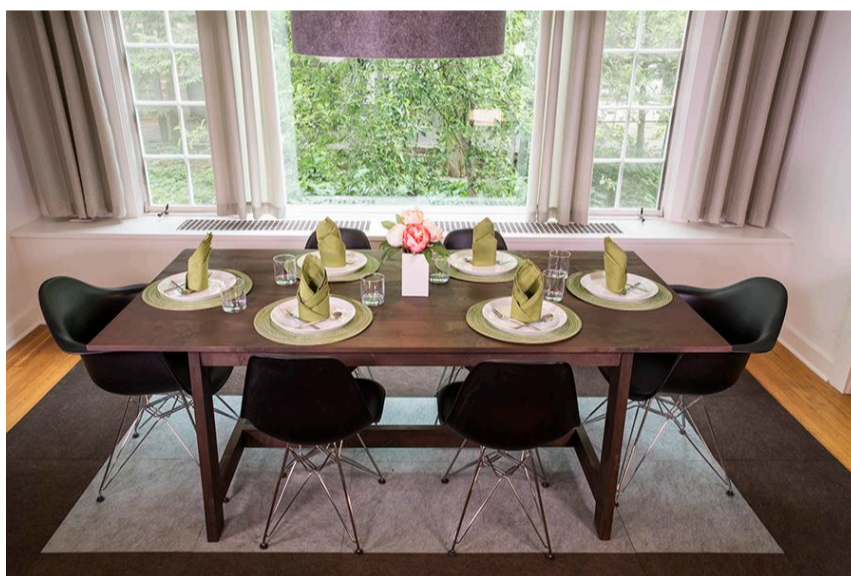

Tools

Kreg Tools

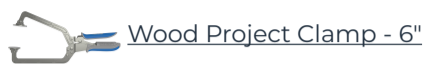

Other Tools

Miter Saw

Square

Tape Measure

Drill (cordless)

Nail Gun

Sander

Air Compressor

Materials

Wood Products

9 Board , 1x4 , 72"

2 Board , 1x4 , 96"

2 Board , 1x3 , 72"

5 Board , 1x8 , 96"

Hardware & Supplies

2 100 Count Box Of 1 1/4" Kreg Screws (We Used Fine-thread For Our Alder Hardwood)

1 Wood Glue

Cut List & Parts

- 8 Leg , 3/4" X 3 1/2" X 29 5/8" Alder
- 4 Short Rail , 3/4" X 3 1/2" X 23 3/4" Alder
- 4 End Stretcher , 3/4" X 3 1/2" X 27 5/8" Alder
- 2 Long Rail , 3/4" X 3 1/2" X 52" Alder
- 1 Center Rail , 3/4" X 3 1/2" X 28 7/8" Alder
- 2 Center Stretcher , 3/4" X 3 1/2" X 52" Alder
- 4 Angle Stretcher , 3/4" X 3 1/2" X 31 3/16" Alder
- 5 Top , 3/4" X 7 1/4" X 76" Alder

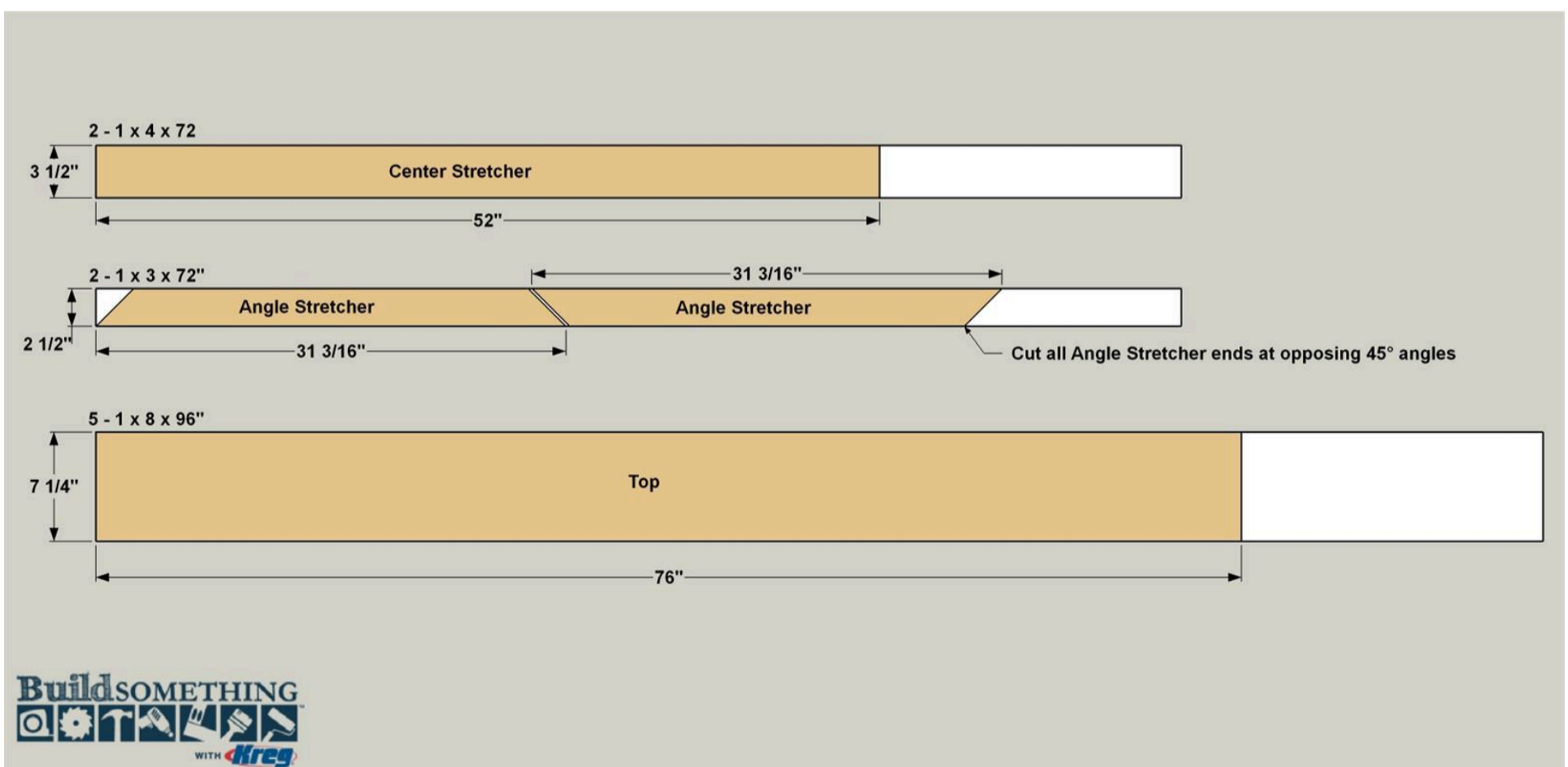
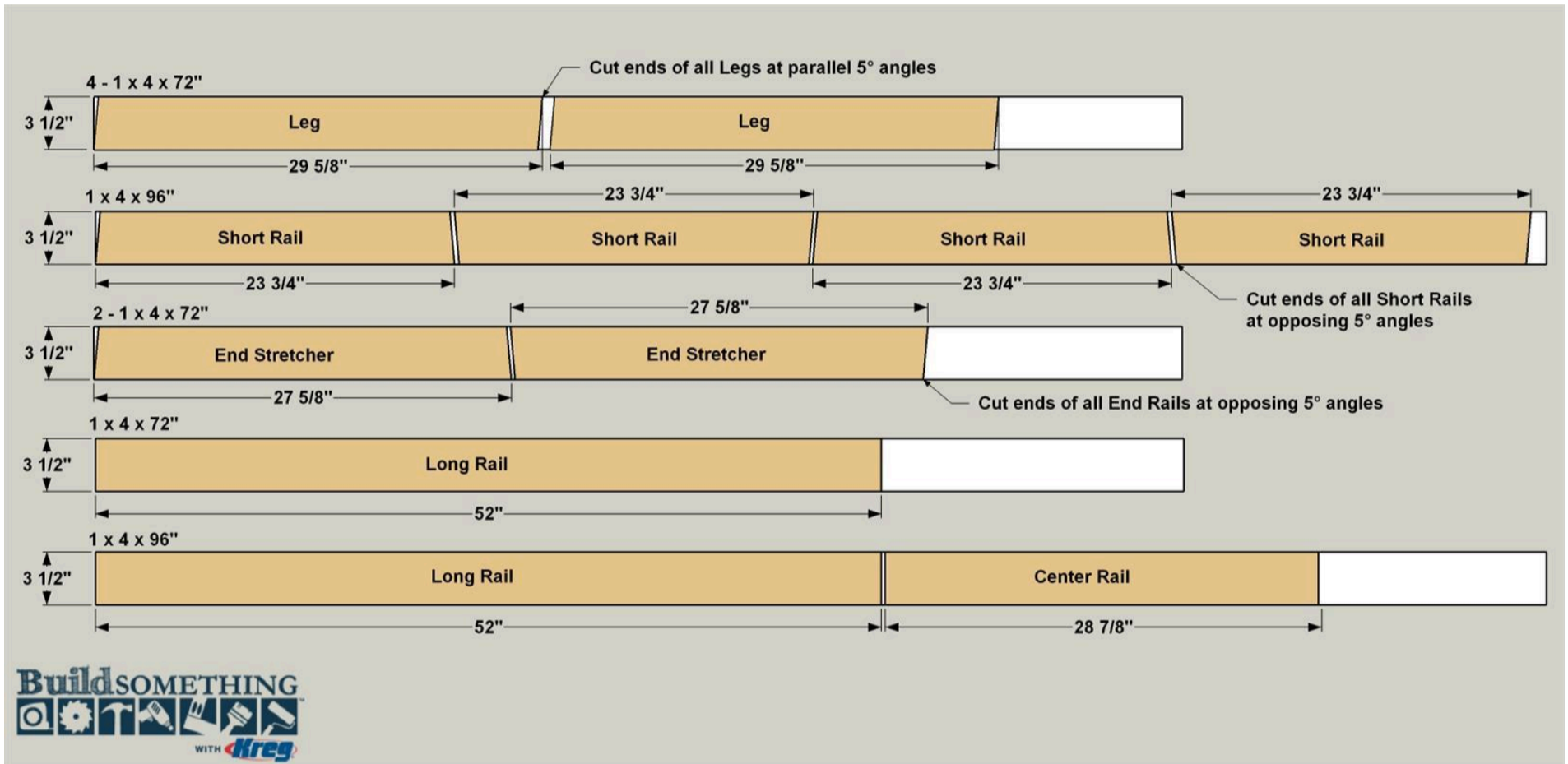

Directions

1

Look Over the Materials List

Before you start building your table, take a look at the procedures, the materials list, and the cutting diagrams. You'll see that most parts of the base are double thickness. This makes the table stronger, and helps with the traditional farmhouse look. But, it allows you to still build everything from standard "1-by" boards. This also allows you use Kreg pocket-hole joinery and then hide the pocket holes on the base. This also means that you'll make multiples of many pieces, but only drill pocket holes in some of them. This will be easy to understand as you go through the procedures. Knowing all of this before you start makes it easier to understand the materials list.

2

Cut the Legs to Length

Set your miter saw to a 5° miter angle, and then cut eight Legs to length from 1x4 boards, making sure to cut the ends at parallel 5° angles, as shown in the cut diagram. Later, these eight pieces will get glued together to form four thick legs. Because you are making multiple identical parts, it's critical that all like pieces end up the exact same length. The best way to do that for the Legs, as well as for the other parts of the project, is to use some type of a stop system on your miter saw, as explained in the how-to video below.

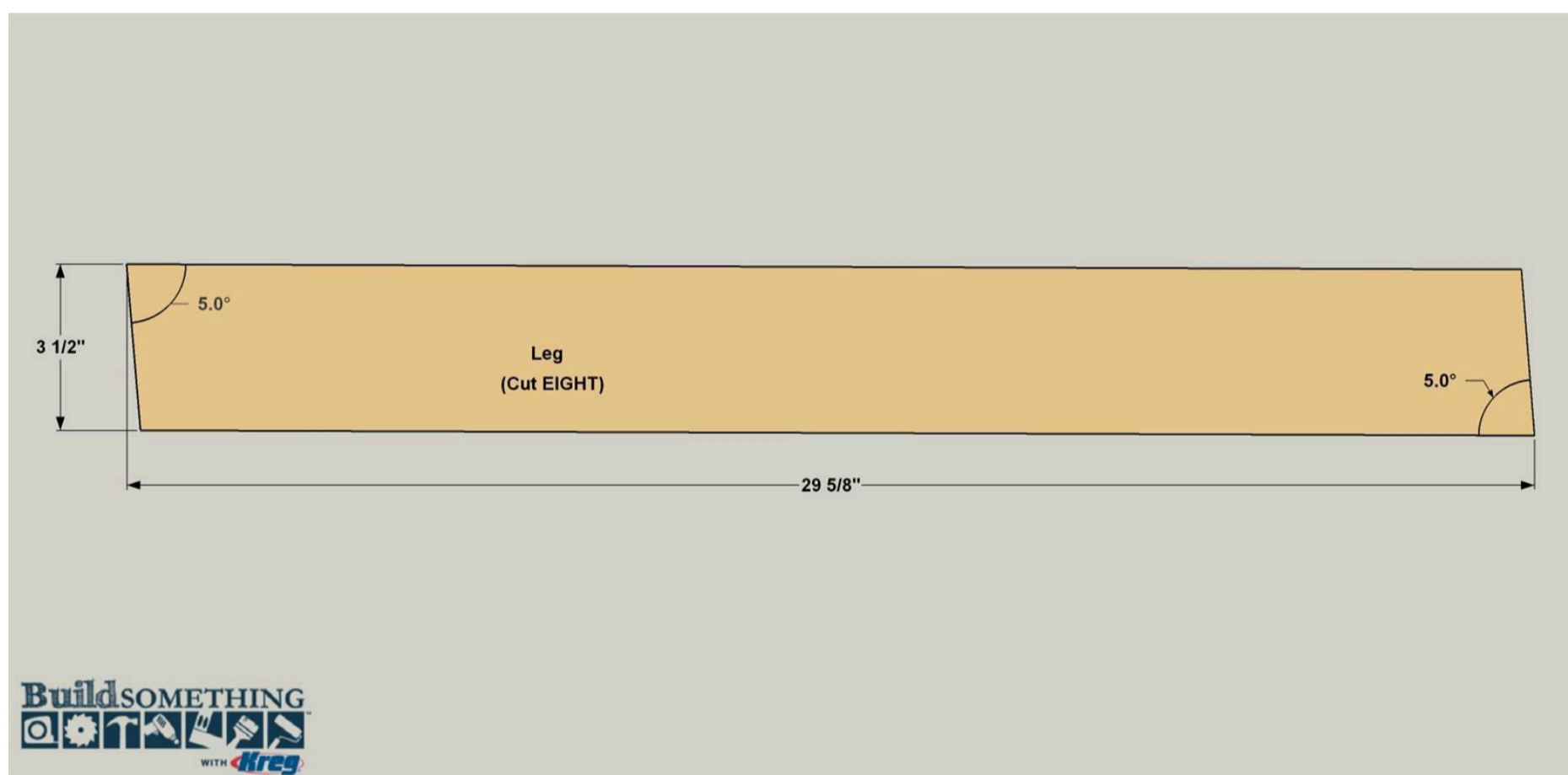

3

Make the Short Rails

Cut four Short Rails to length from 1x4 boards as shown in the cut diagram. The ends of these pieces are cut at 5°, as well, but this time make sure that you cut them so that the angles are opposing, as shown, instead of parallel. You can set two of the Short Rails aside. They won't need pocket holes. For the other two, set your Kreg Jig for 3/4"-thick material (the setting you'll use throughout this project, and then drill pocket holes where shown. You'll drill holes at the ends on one face. Then flip the pieces over and drill holes along the shorter edge. Later, these will be used to attach the table top.

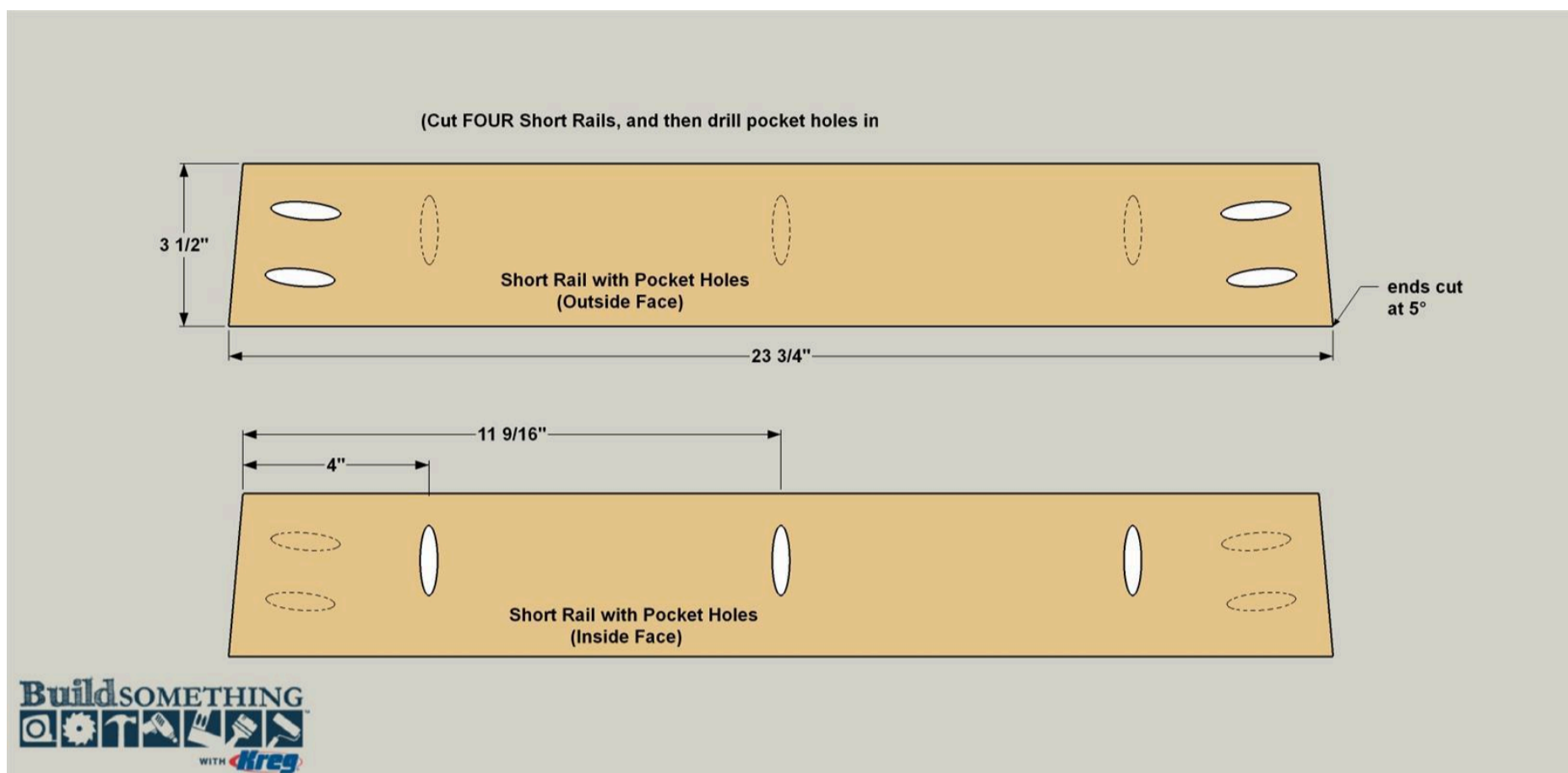

4

Make the End Stretchers

Now you can cut four End Stretchers to length from 1x4 boards as shown in the cut diagram. Again, these have opposing 5° angles on the ends. Set two of the End Stretchers aside, and then drill pocket holes at the ends of the other two, as shown. There are no pocket holes on the other face of these pieces.

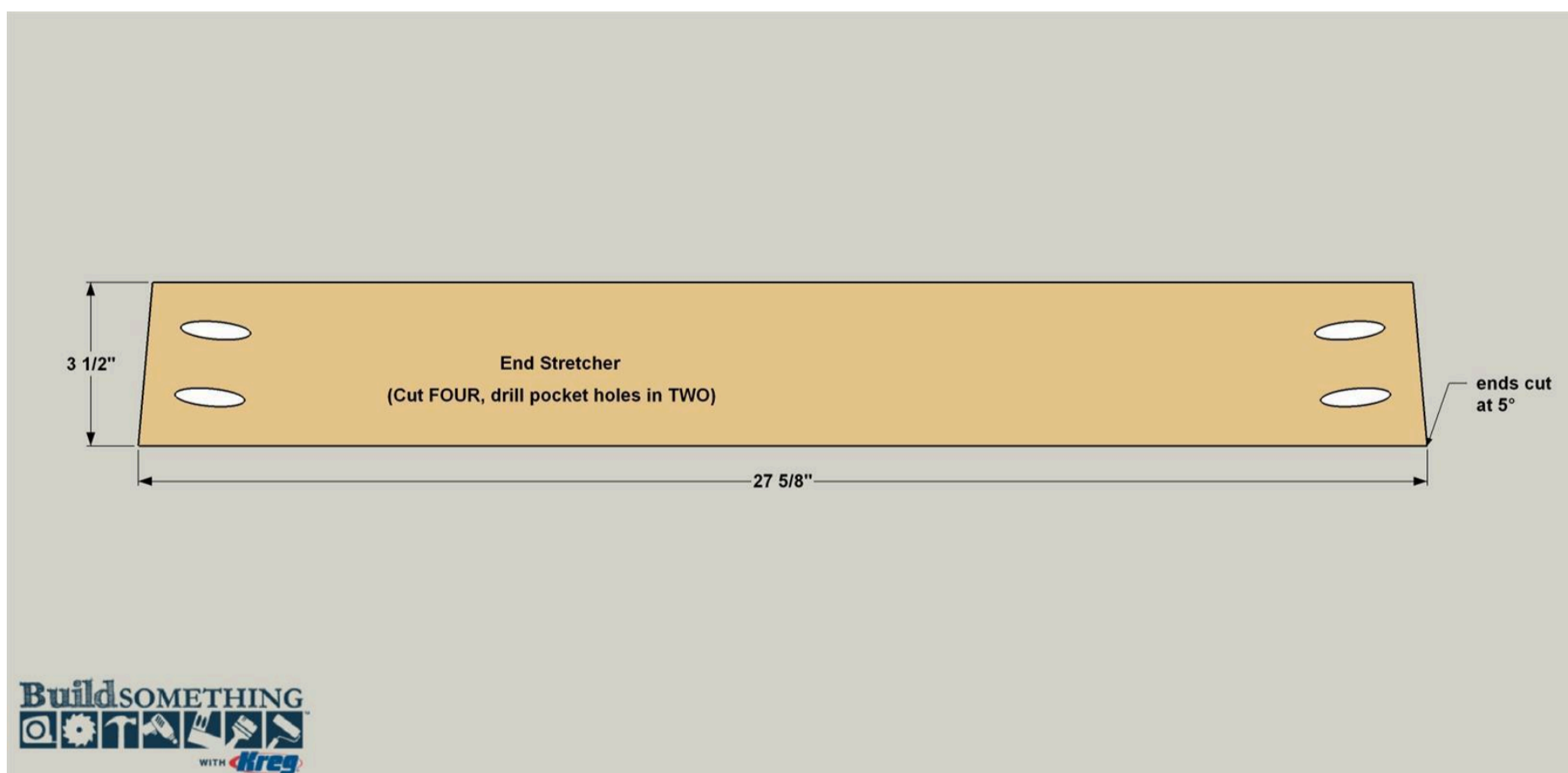

5

Assemble the Ends

Gather the short Rails and End Stretchers that have pocket holes, and four of the Legs. Position two Legs against one Short Rail, as shown. The pocket holes at the ends of the Short Rail should face up. Attach the Short Rail to the Legs using glue and 1 1/4" pocket-hole screws. We chose fine-thread screws for our alder hardwood. You can find more about choosing screws in the how-to video below. Clamp the pieces during assembly to keep the joints flush. Next, position the End Stretcher as shown, apply glue to the ends, and then secure it using pocket-hole screws. Repeat this process to assemble the other end. Sand the faces of both assemblies smooth, making sure that the joint areas are flush.

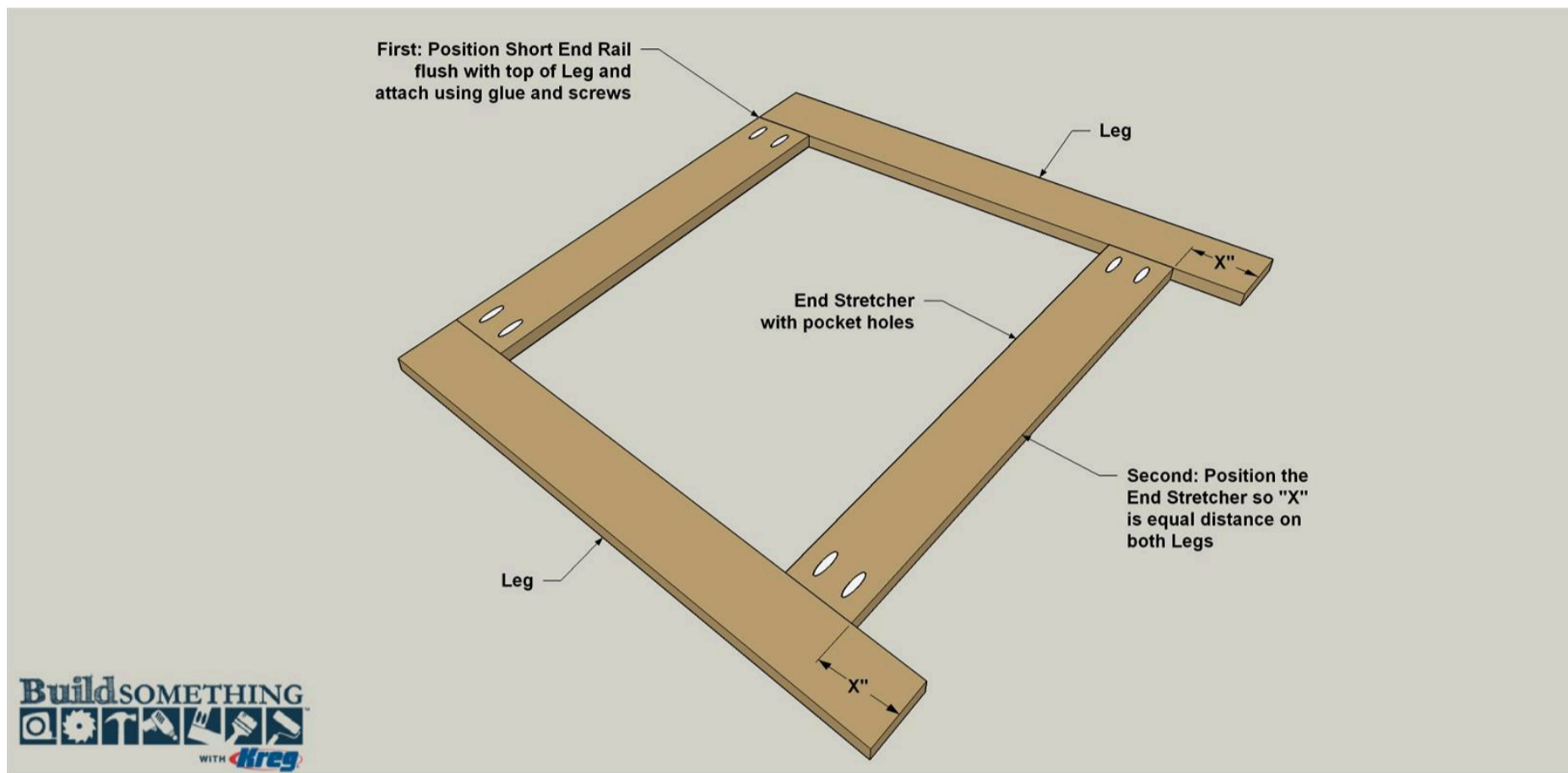

6

Make the Long Rails

Cut two Long Rails to length from 1x4 boards, as shown in the cut diagram. Then drill pocket holes at the locations shown. Sand the faces smooth.

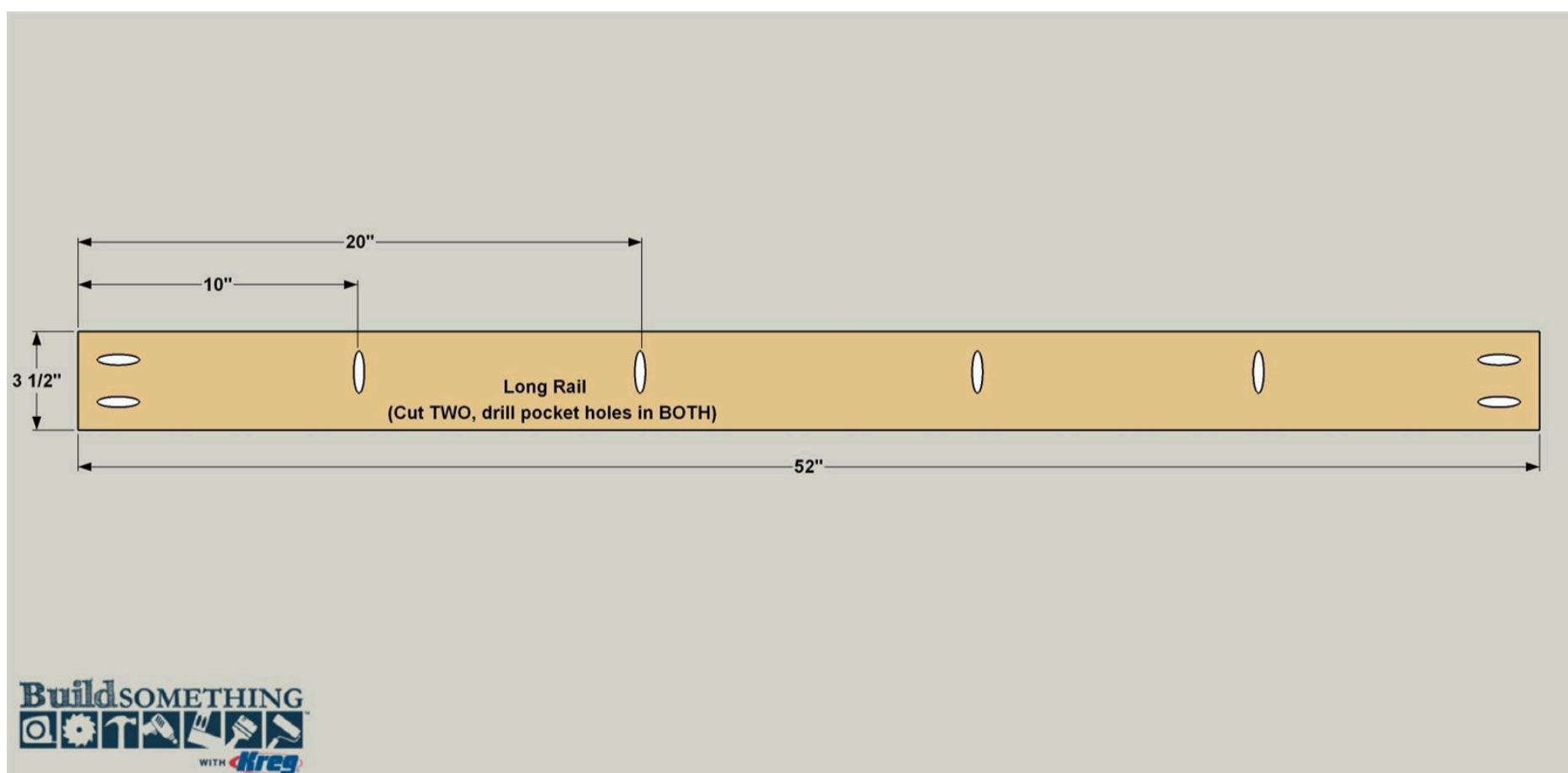

7

Attach the Long Rails

Flip one end assembly upside down and stand it up on a work surface. Make sure the pocket holes along the edge of the Short Rail face toward the Long Rails, as shown. Position the Long Rails as shown, making sure that the pocket holes along the edge are oriented correctly for attaching the table top later. Apply glue to the ends of the Long Rails, and then secure them to the end assembly using pocket-hole screws. Repeat the process to attach the other end assembly.

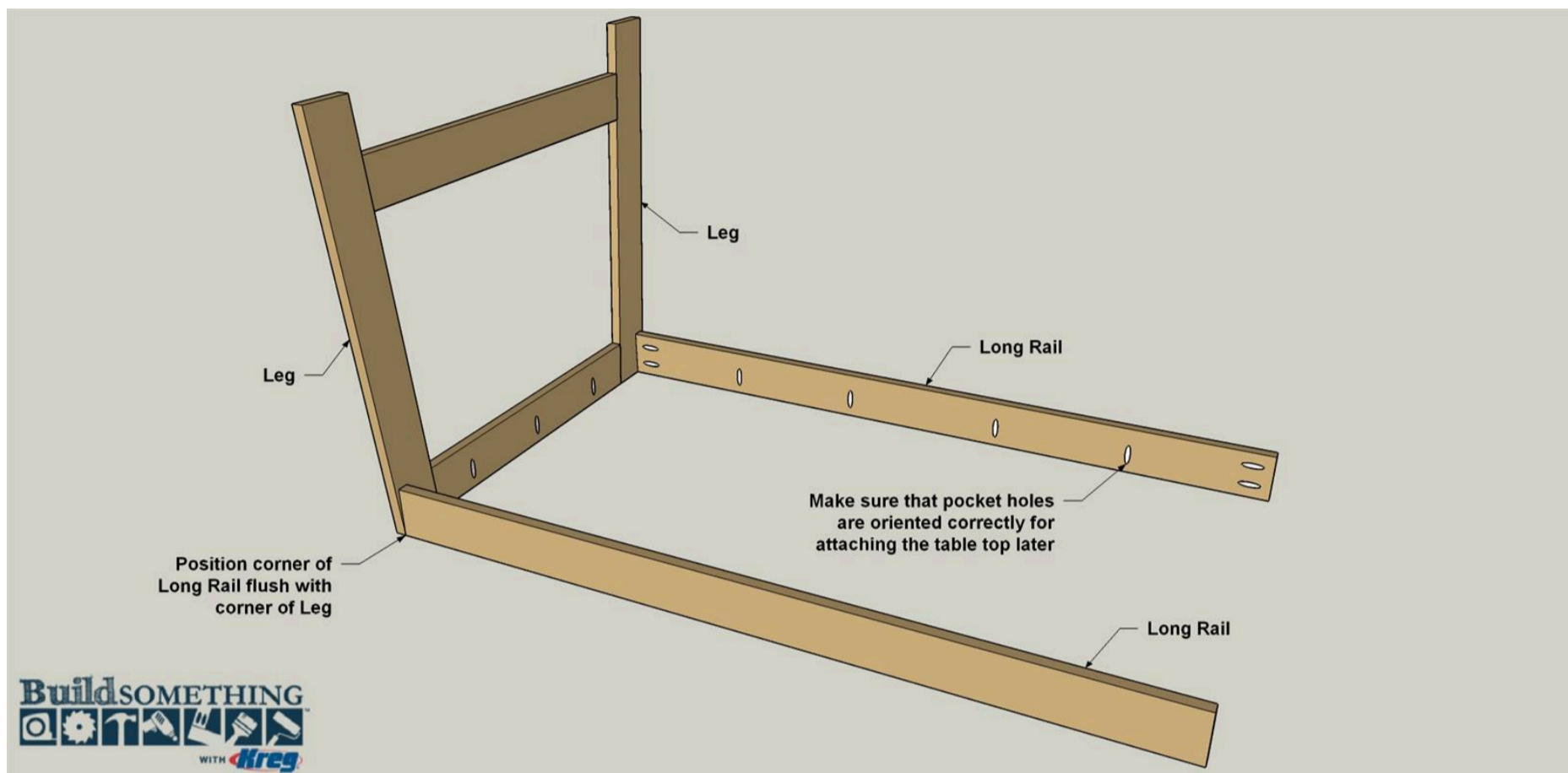

8

Make the Center Rail

Cut one Center Rail to length from a 1x4 board, as shown in the cut diagram. Drill pocket holes at the locations shown. Sand the faces smooth.

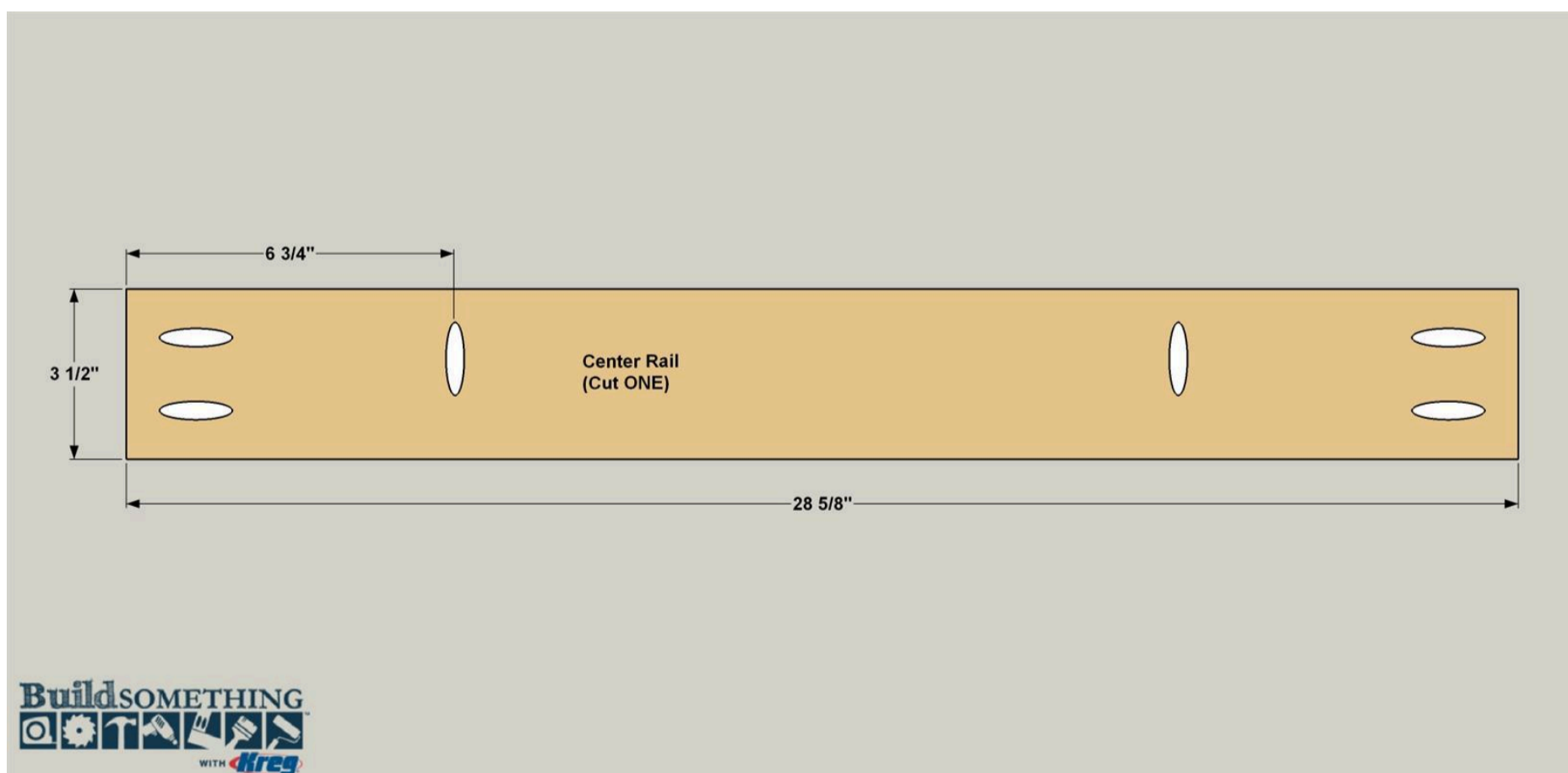

9

Add the Center Rail

Flip the base assembly upright. Mark the location of the Center Rail, apply glue to the ends, and then position the Center Rail between the Long Rails. Secure the Center Rail using glue and pocket-hole screws.

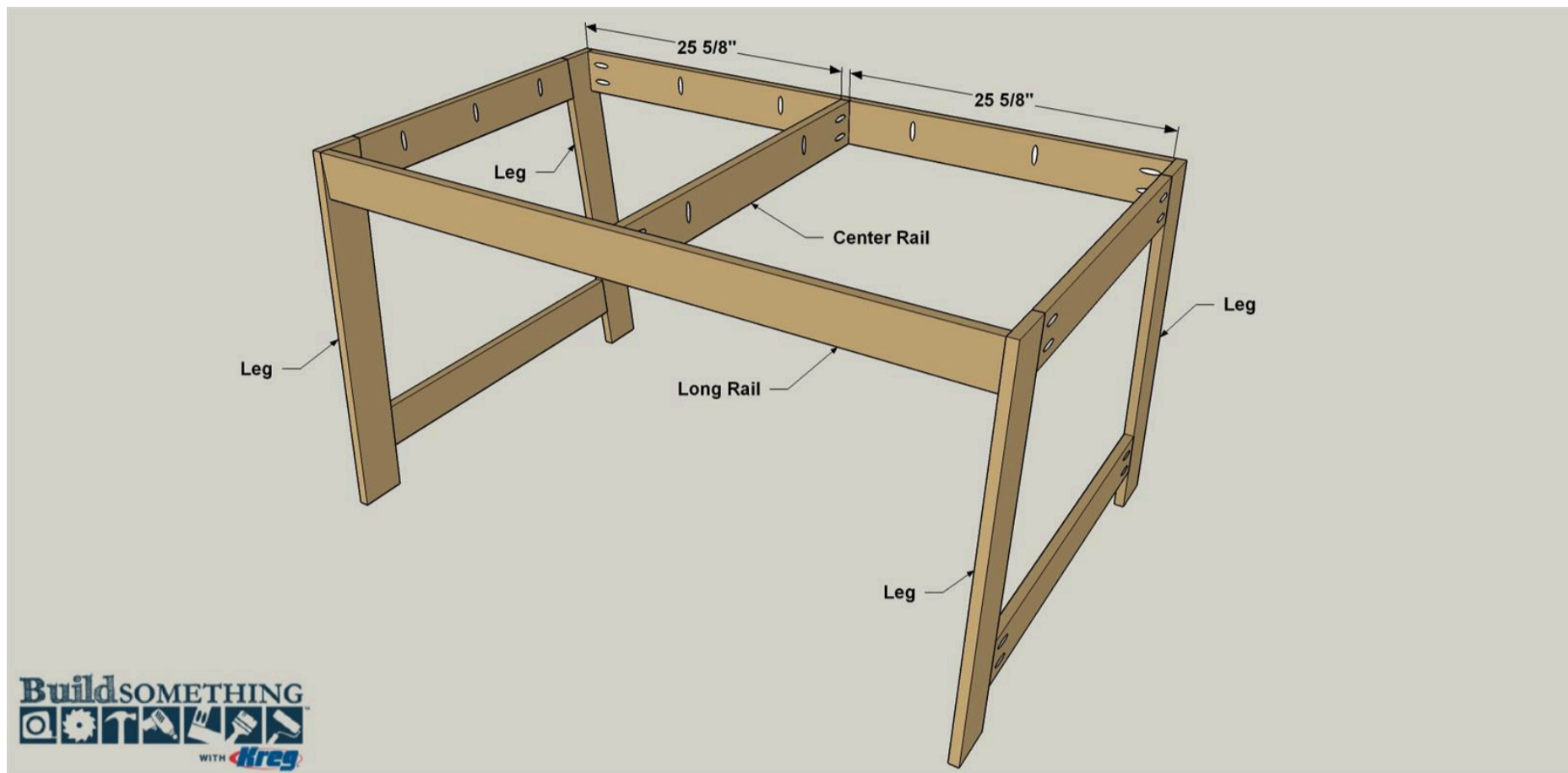

10

Make the Center Stretcher

Cut two Center Stretchers to length from 1x4 boards, as shown in the cutting diagram. Set one aside for now. Then drill pocket holes where shown in the second one.

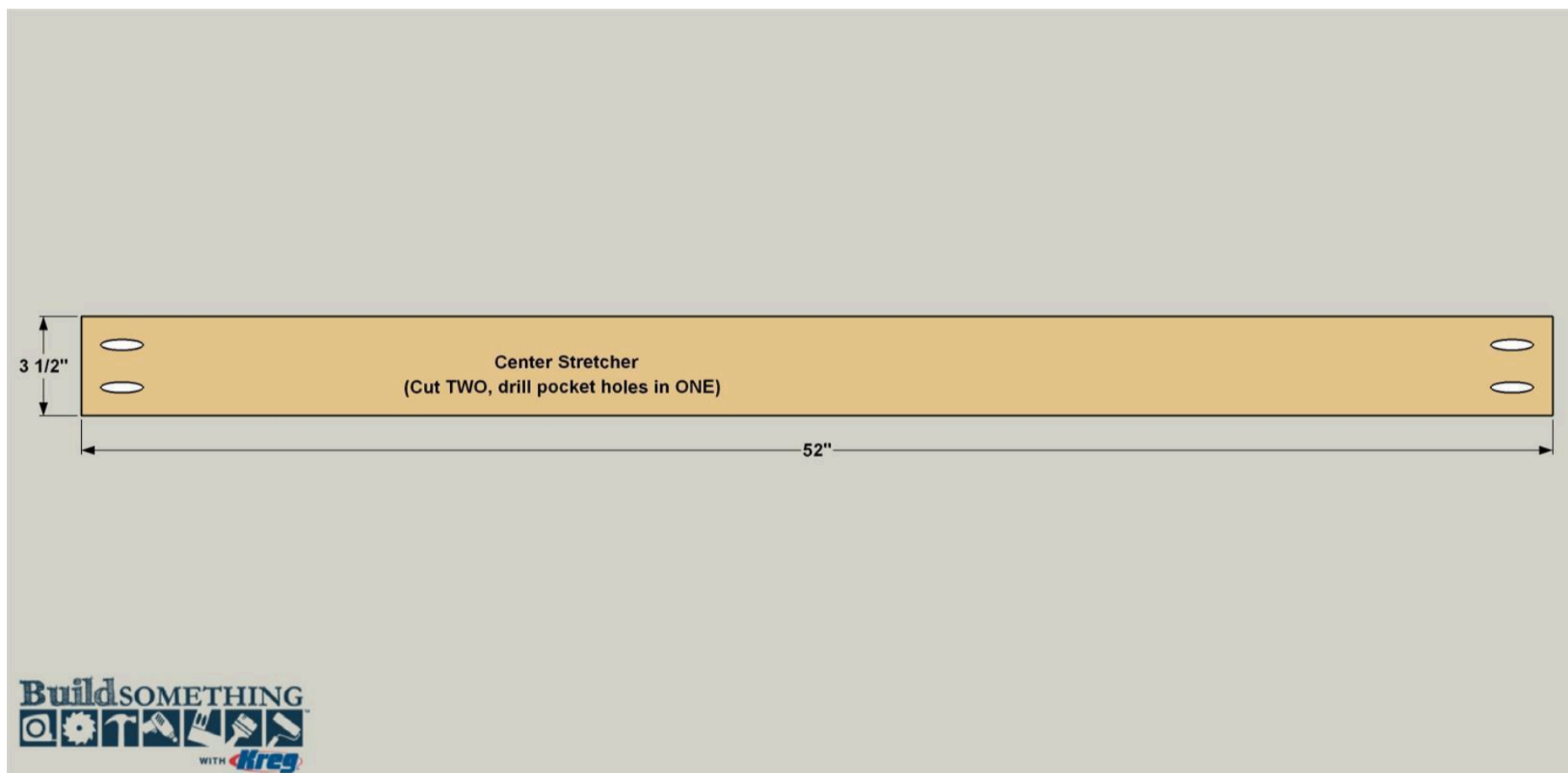

11

Attach the Center Stretcher

Mark the location of the first Center Stretcher (the one with pocket holes) on each End Stretcher. Note that this Long Stretcher isn't centered on the length of the End Stretchers. It's offset to one side so that, when you glue on the other Center Stretcher later, the pair will be centered. Apply glue to the ends of the Long Stretcher, position it so the pocket holes face to the center of the table, and then secure it using pocket-hole screws.

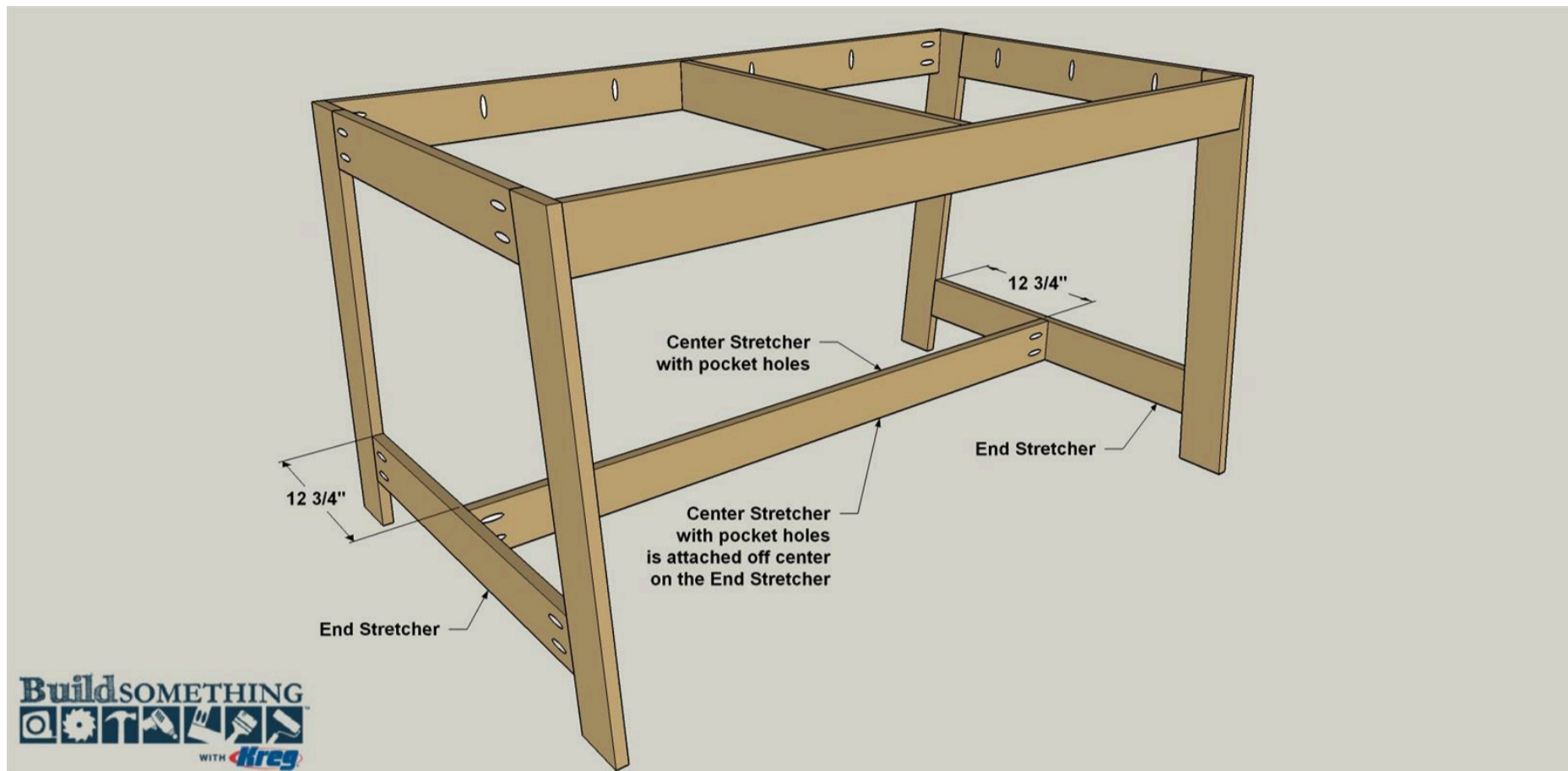

12

Make the Angle Stretchers

Cut four Angle Stretchers to length from 1x3 boards so that the ends have opposing 45° angles, as shown in the cutting diagram. Set two of the Angle Stretchers aside for now. Then drill pocket holes at the ends of the other two, as shown.

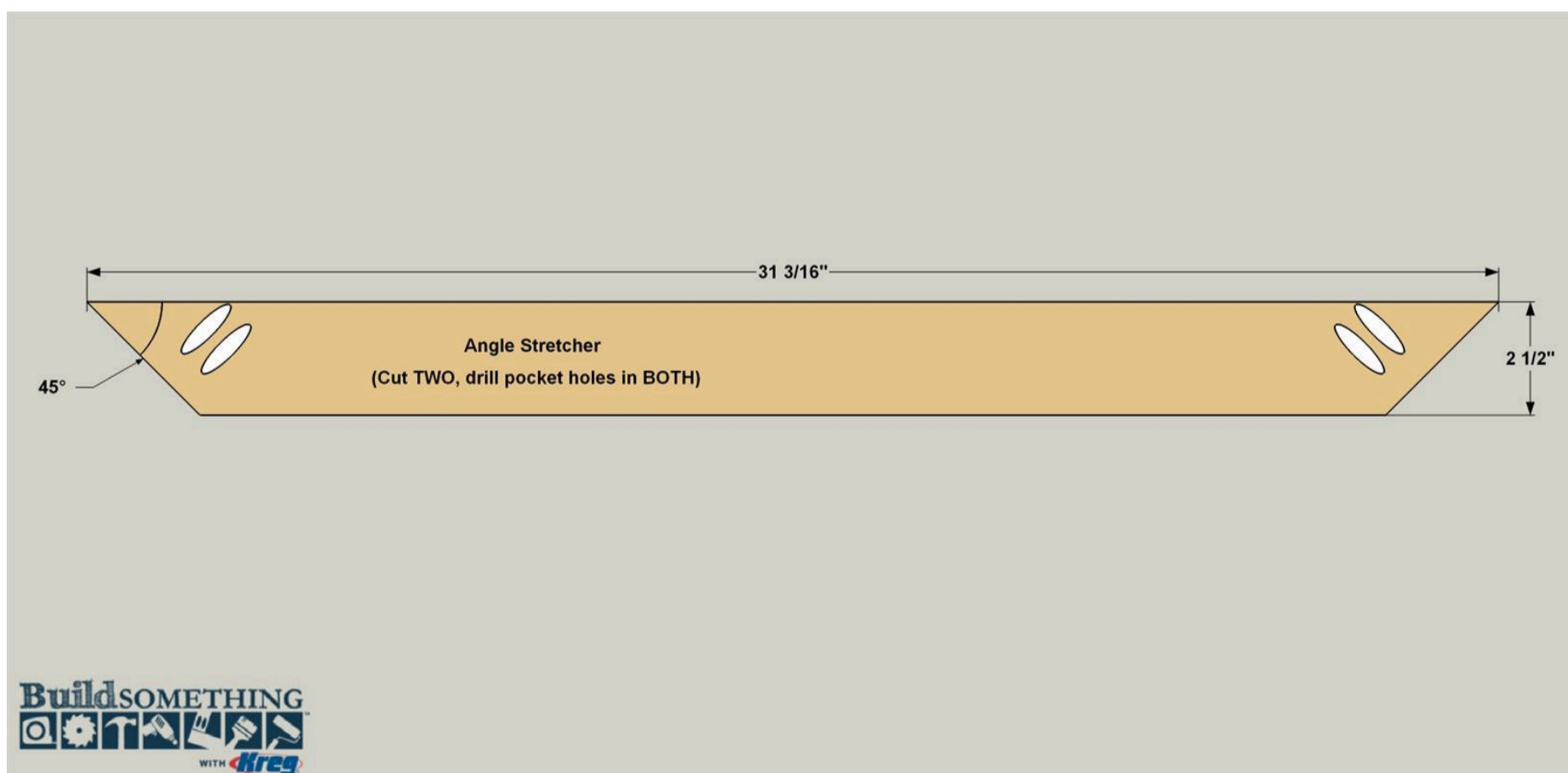

13

Attach the Angle Stretchers

Place the one of Angle Stretchers that has pocket holes on to the Center Stretcher. Make sure the pocket holes face the inward. Then attach the Angle Stretcher to the Center Stretcher and to the Center Rail where shown using glue and pocket-hole screws. Repeat the process for the other Angle Stretcher.

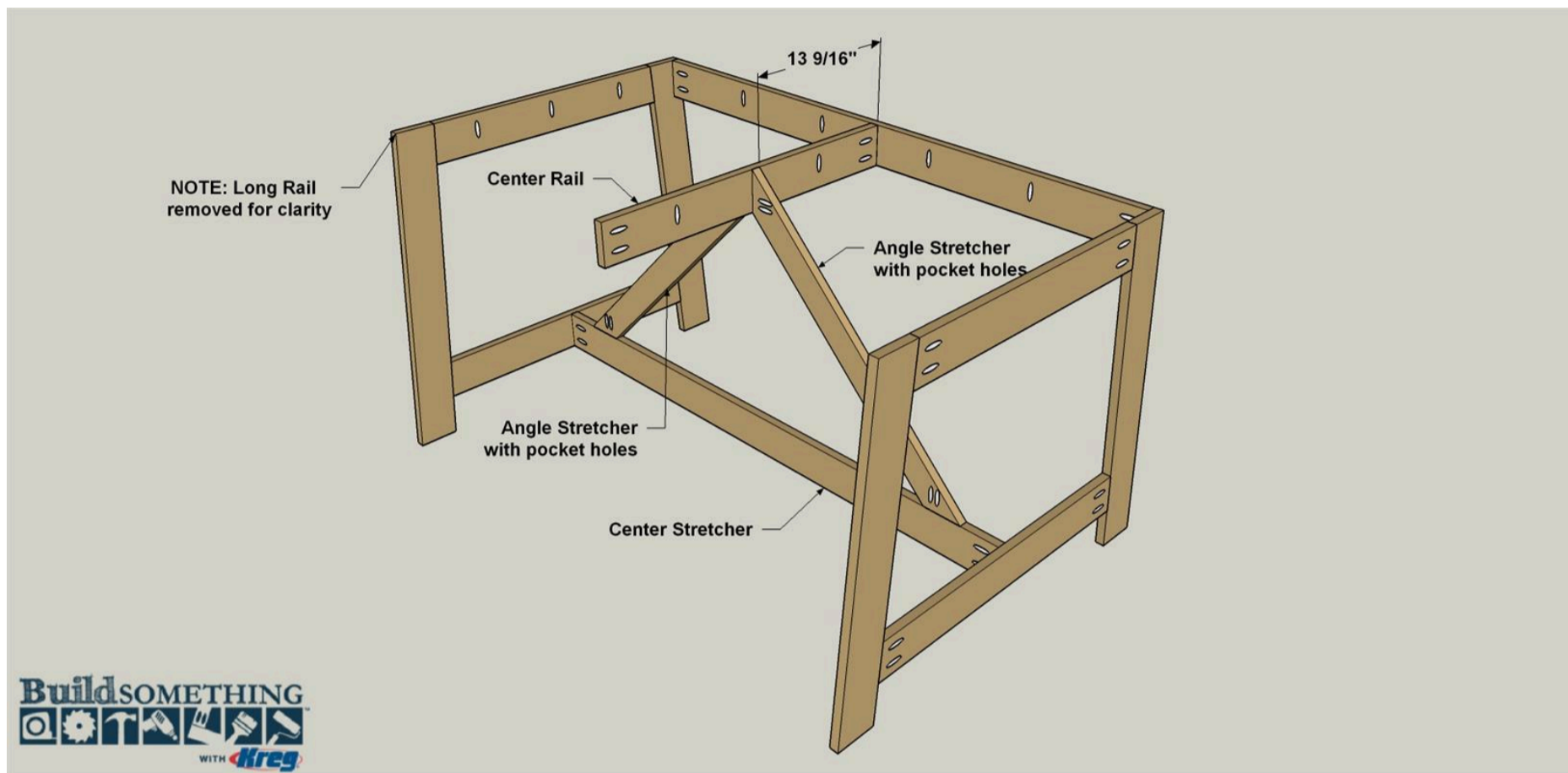

14

Add the Second Layer of Parts

With the table base structure complete, it is time to cover the end assemblies, the Long Stretcher, and Angle Stretchers with the second layer of parts. To do this, simply glue and clamp all of the “extra” pieces you made over their twins, as shown. You’ll need quite a few clamps to hold the pieces in place while the glue dries. If you have a brad nailer, though, you can use just a couple of clamps to hold the pieces in place, and then drive in brads to hold everything while the glue dries. That way, you can move the clamps and move on.

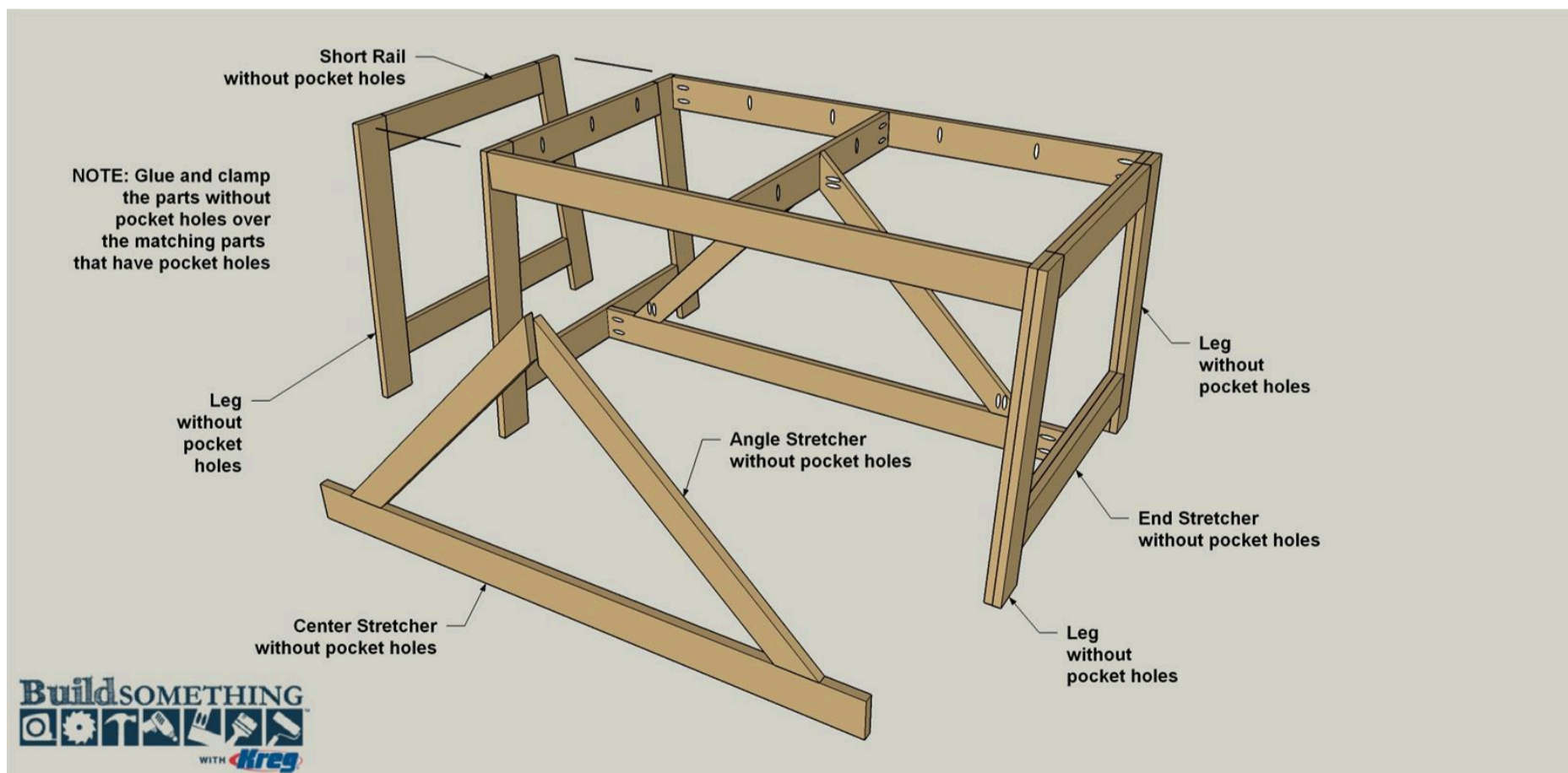

15

Make the Top Boards

Cut five Top boards to length from 1x8 boards, as shown in the cut diagram. Drill pocket holes in four of the boards, as shown.

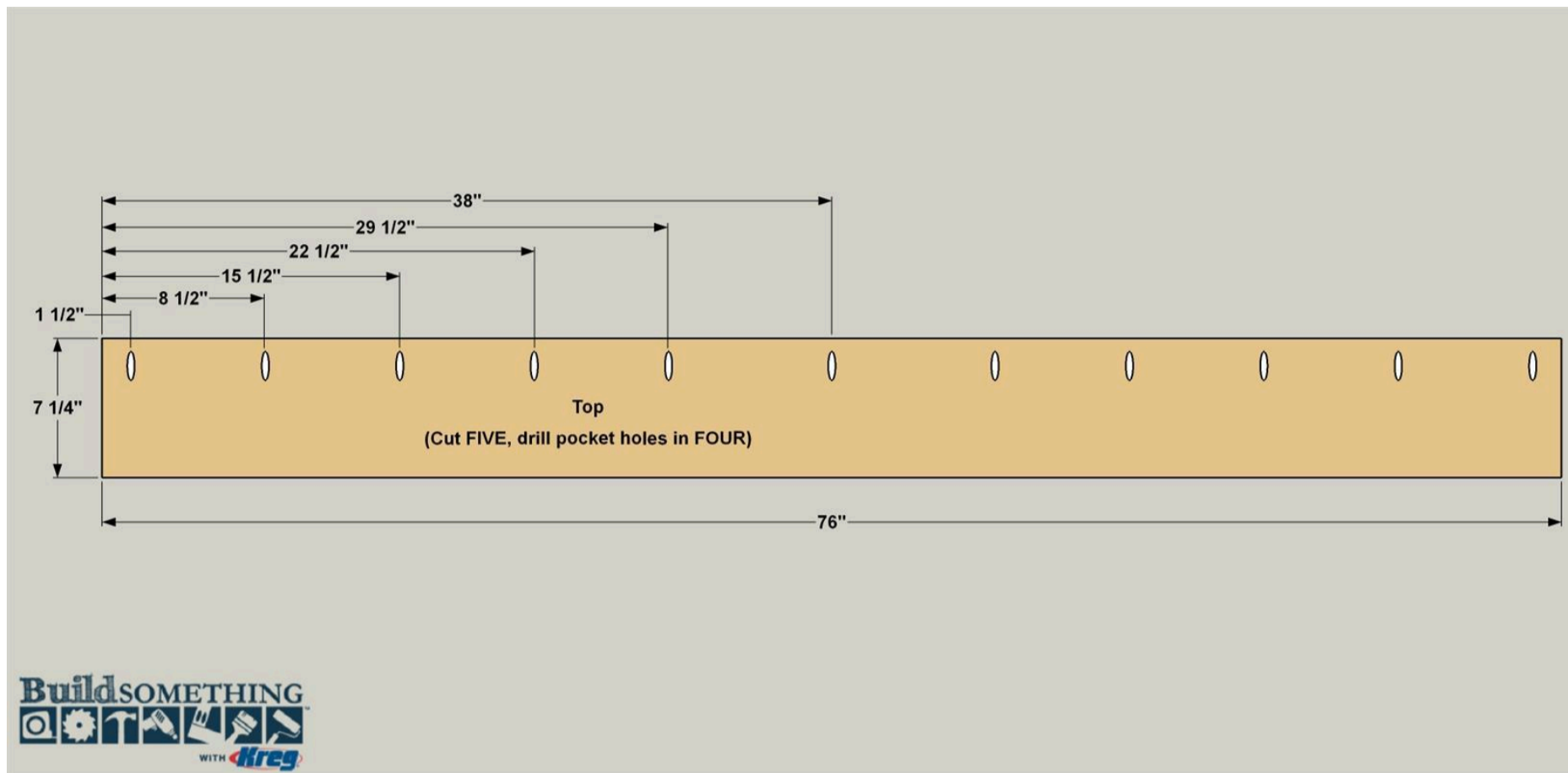

16

Assemble the Top

On a flat work surface, lay the boards out. Apply glue to the entire edge of the first board and then clamp it to the second. Make sure the seams are flush and then secure the two boards together using pocket-hole screws. Repeat this for the remaining boards to complete the top. When the glue dries, sand the face and underside flat and smooth.

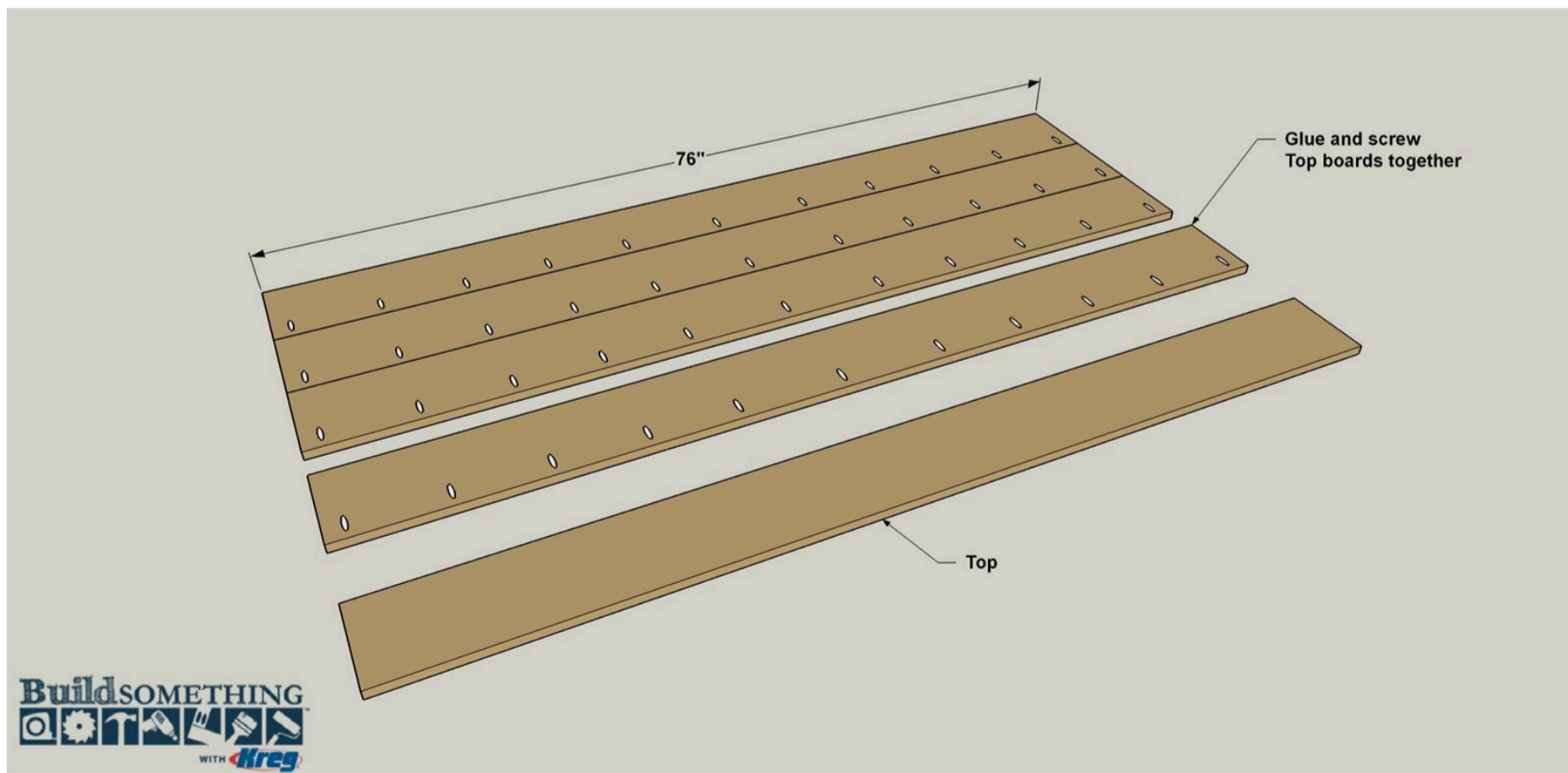

17

Attach the Top to the Base

Place the tabletop on your work surface with the pocket holes facing up. Place the table base upside down on the top. Position the base so the top overhang is equal from end to end as well as side to side. When the base is in position, secure it to the top using pocket-hole screws. Don't use glue here.

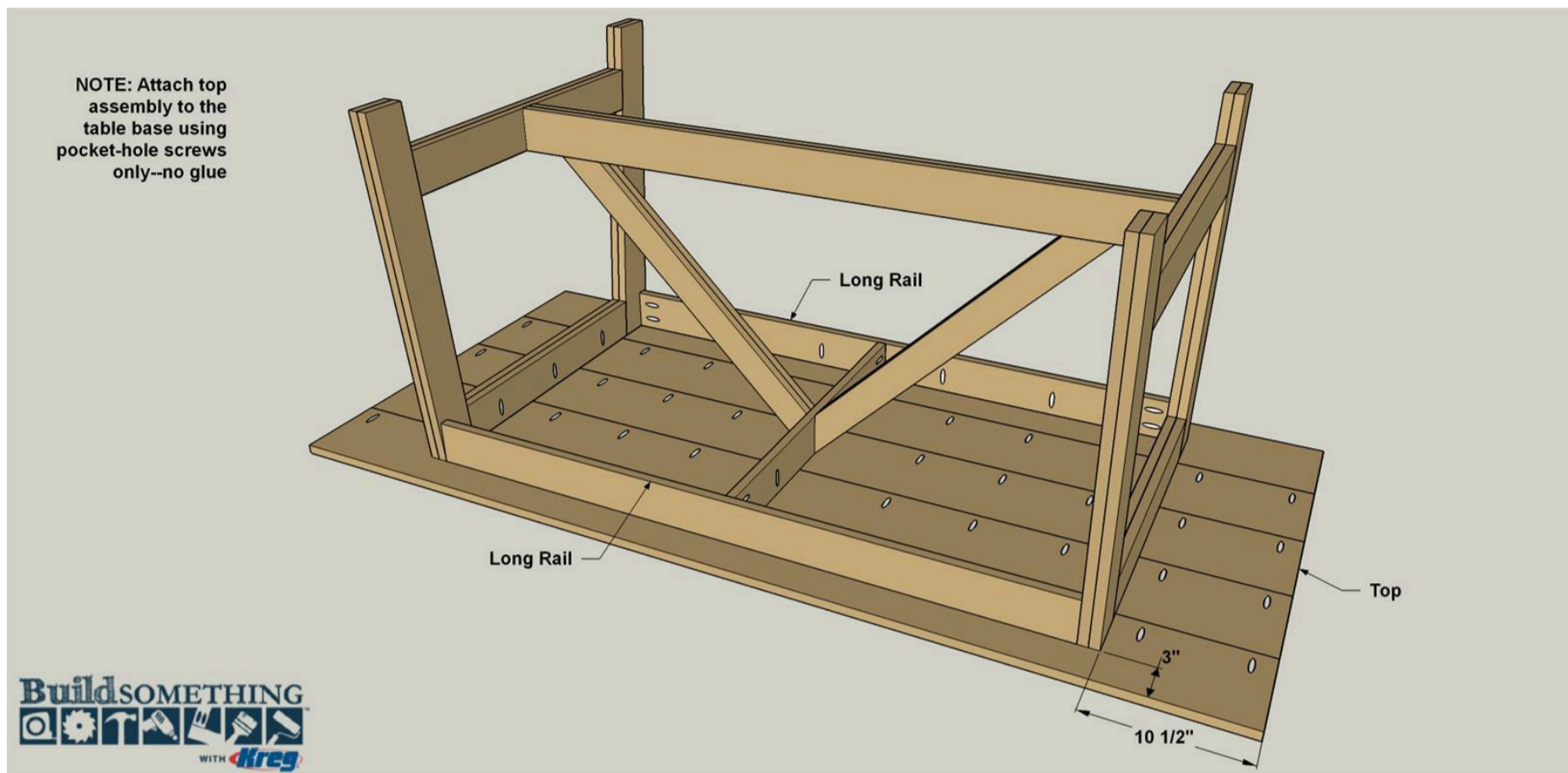

18

Finish the Table

Complete a final sanding of all of the parts, clean the table thoroughly, and apply your favorite finish. We used a "Java" colored gel stain, followed by two coats of satin wipe-on urethane.