

Cedar Planter

By **Kreg Tool**

Difficulty

Easy

This great-looking planter makes the perfect place for your favorite plants and flowers. It's sized to hold an 18" round plastic pot, which you can pick up in any garden center. Thanks to the planter's large size, it offers plenty of space to create a stunning display on your porch, deck, or patio.

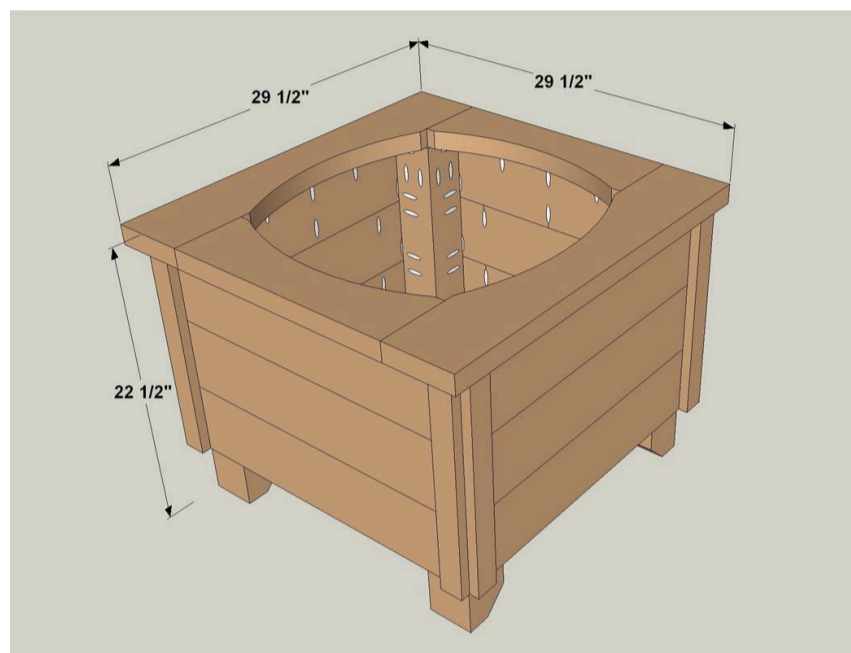

Tools

Kreg Tools



Other Tools

Jigsaw

Miter Saw

Tape Measure

Drill (cordless)

Sander

Materials

Wood Products

2 Board , 1x2 , 96"

4 Board , 1x6 , 96"

1 Board , 2x4 , 96"

2 Board , 2x6 , 96"

1 Board , 4x4 , 96"

Hardware & Supplies

100 1 1/4" Exterior-rated Pocket-hole Screws

46 2 1/2" Exterior-rated Pocket-hole Screws

32 1 1/4" Exterior Brad Nails

1 Quart Exterior Stain Or Finish

Cut List & Parts

- 6 Side Slats , 3/4" X 5 1/2" X 25"
- 4 Legs , 3 1/2" X 3 1/2" X 21"
- 4 Bottom Rails , 1 1/2" X 3 1/2" X 18"
- 6 End Slats , 3/4" X 5 1/2" X 26 1/2"
- 2 Long Top Trim , 1 1/2" X 5 1/2" X 29 1/2"
- 2 Short Top Trim , 1 1/2" X 5 1/2" X 18 1/2"
- 8 Edge Trim , 3/4" X 1 1/2" X 16 1/2"
- 3 Bottom Slats , 3/4" X 5 1/2" X 18"

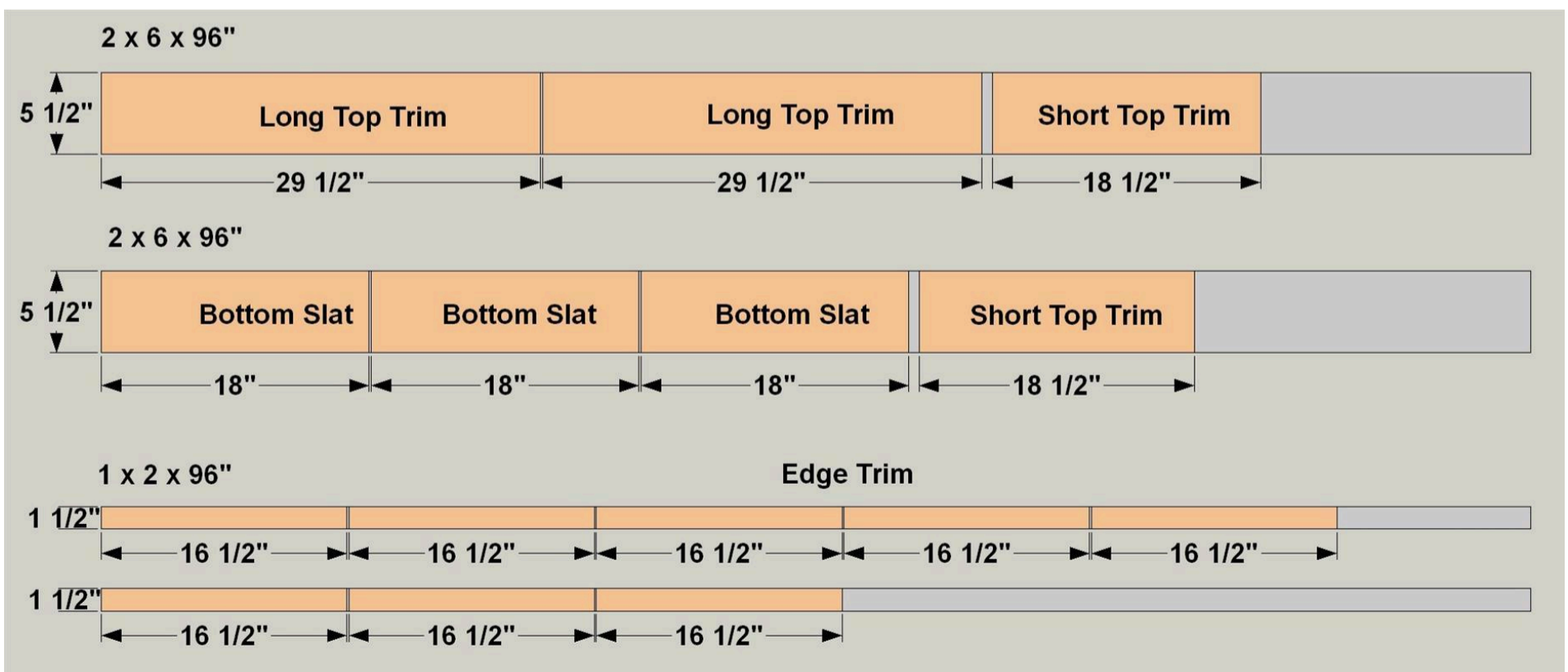
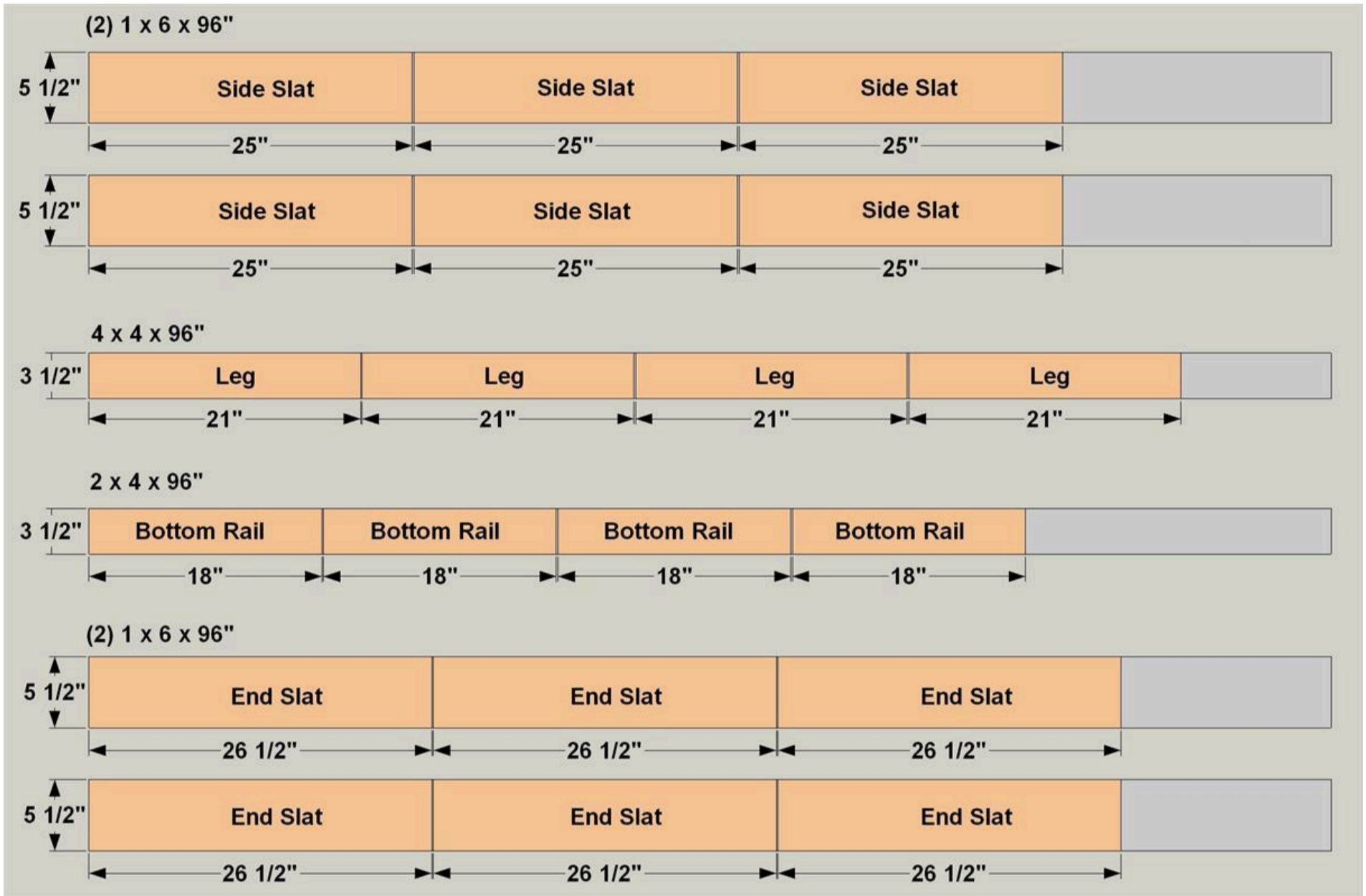

Directions

1

Create the Side Slats

Cut six Side Slats to length from 1x6 boards, as shown in the cutting diagram. Then, with your pocket-hole jig set up for 3/4" material, drill pocket holes in the Side Slats as shown.

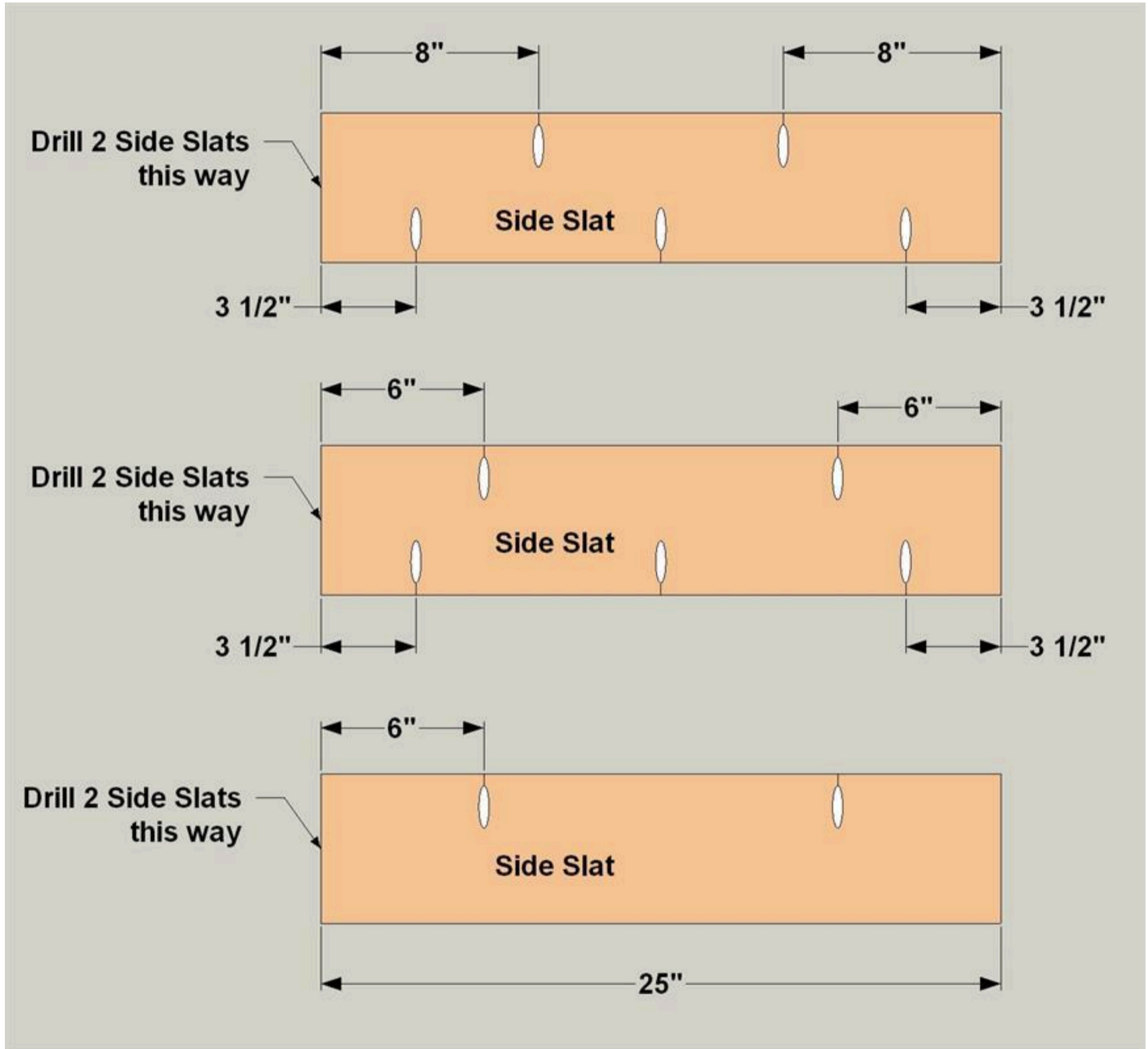

2

Assemble Side Panels

Create two side panels by joining Side Slats together as shown using 1 1/4" exterior-rated pocket-hole screws.

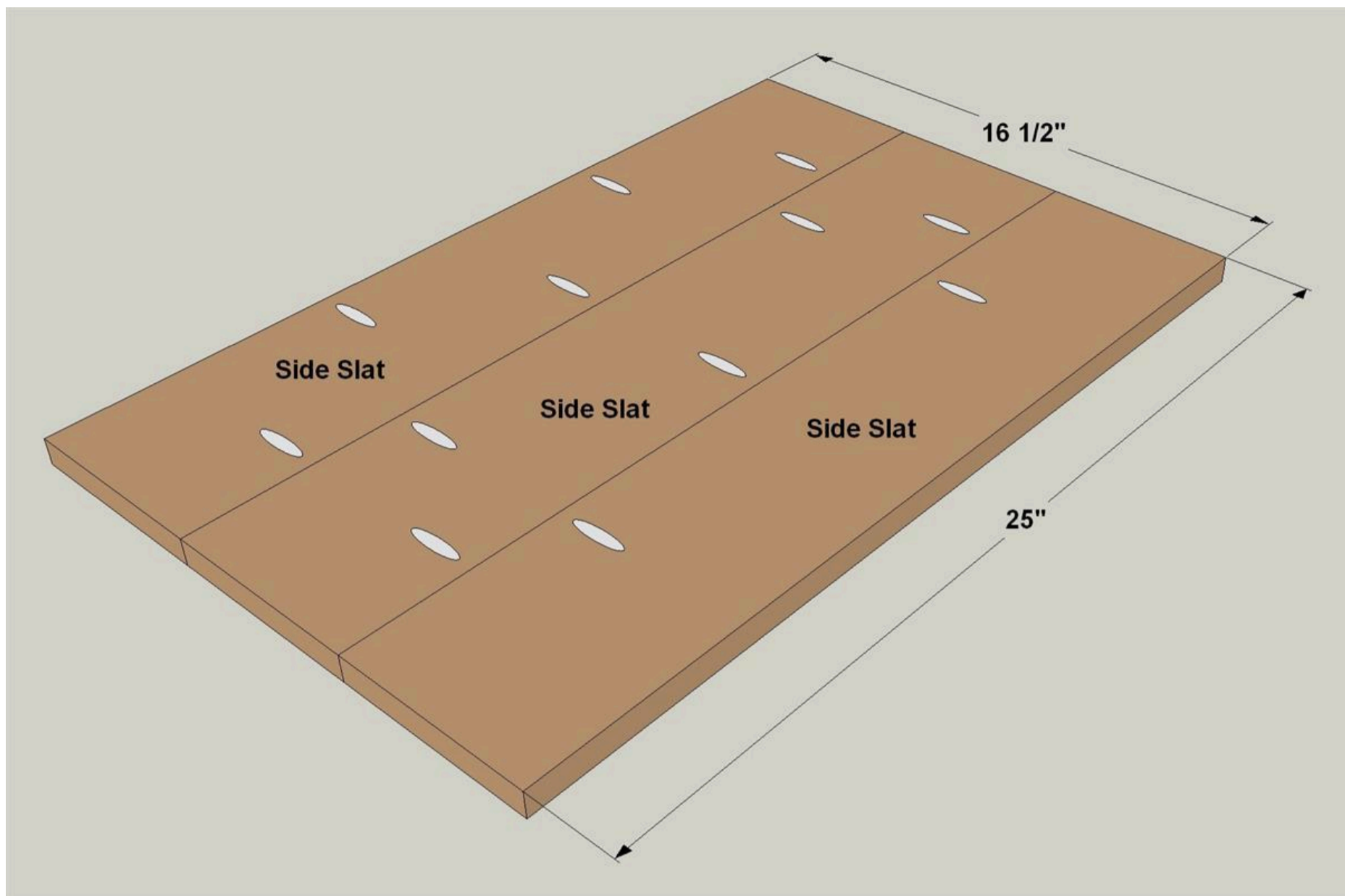

3

Create the Legs

Cut four Legs to length from a 4x4 board, as shown in the cutting diagram. Next, cut the angle on the end of each leg. With that done, you can drill pocket holes, as shown, in the two inside faces of each leg. Note that the pocket holes at the upper end are drilled with your pocket-hole jig set up for 1 1/2" material. The holes along the edges are drilled with your jig set for 3/4" material.

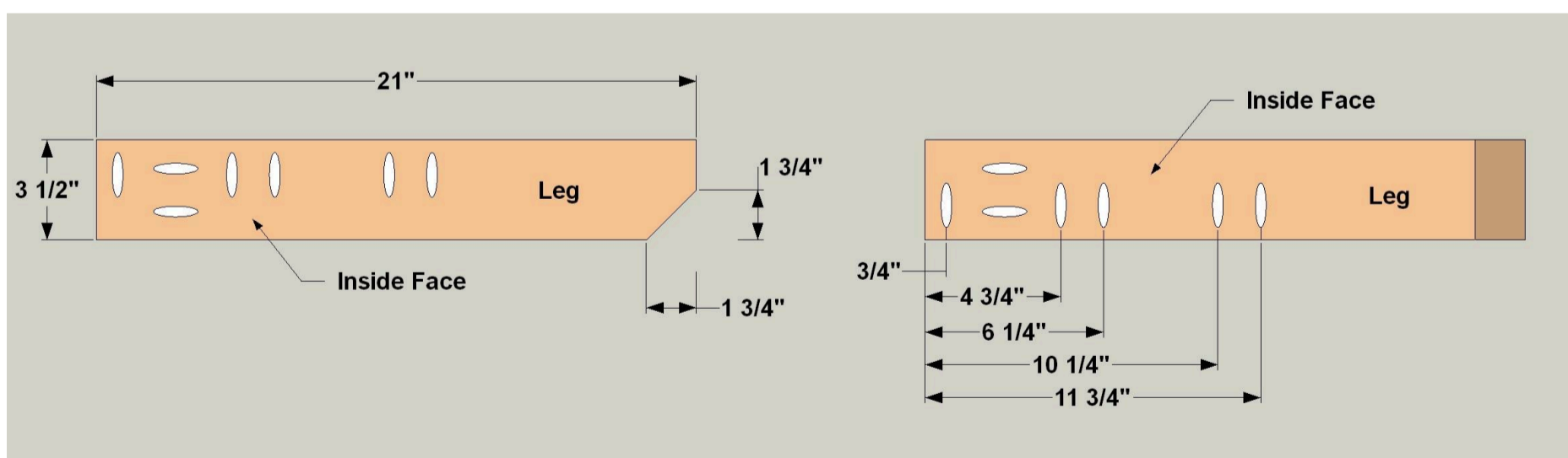

4**Make Bottom Rails**

Cut four Bottom Rails to length from a 2x4 board, as shown in the cutting diagram. Then drill pocket holes, as shown. Like with the Legs, the pocket holes in the Bottom Rails require two jig setups: the end holes are drilled with the jig set for 1 1/2" material. The holes along the edge are drilled with the jig set for 3/4" material.

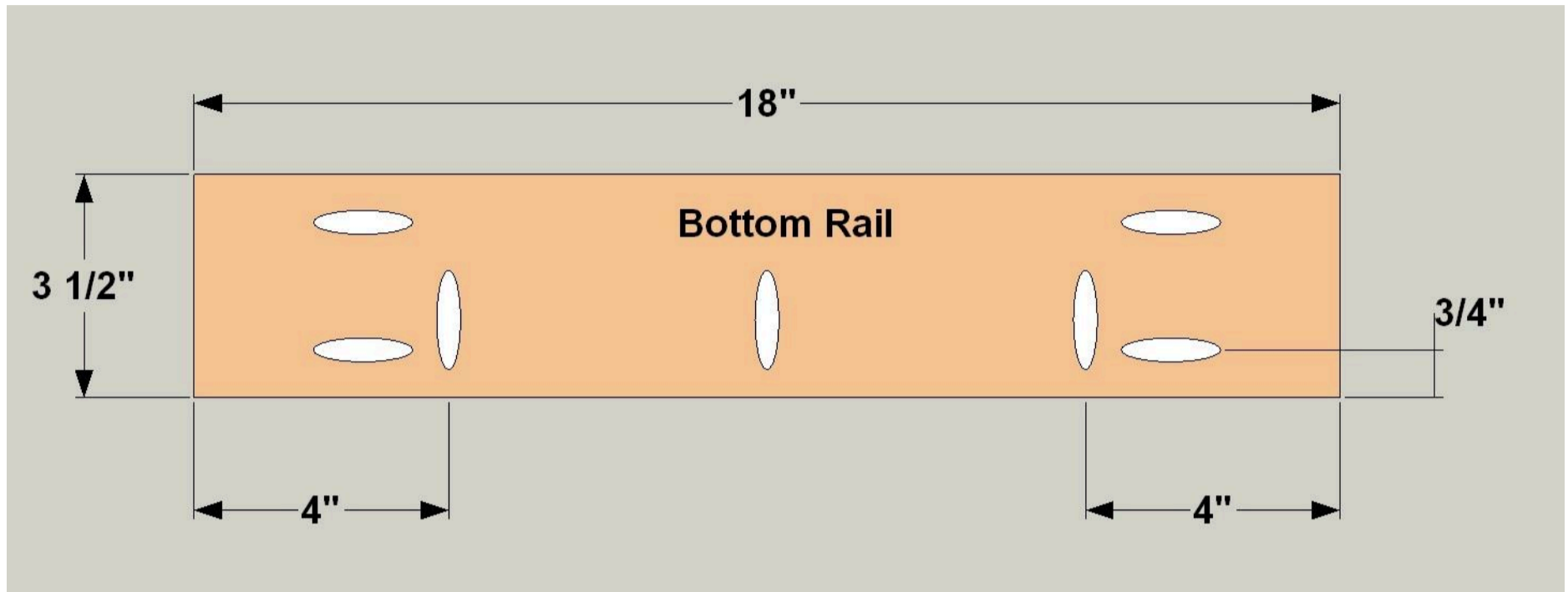

5**Make Two Side Assemblies**

Now you can join the Legs to the Bottom Rails using 2 1/2" exterior-rated pocket-hole screws. Then attach the side-panel assembly using 1 1/4" exterior-rated pocket hole screws. Note that the side panels get screwed to the Legs and to the Bottom Rails. Create two of these side assemblies.

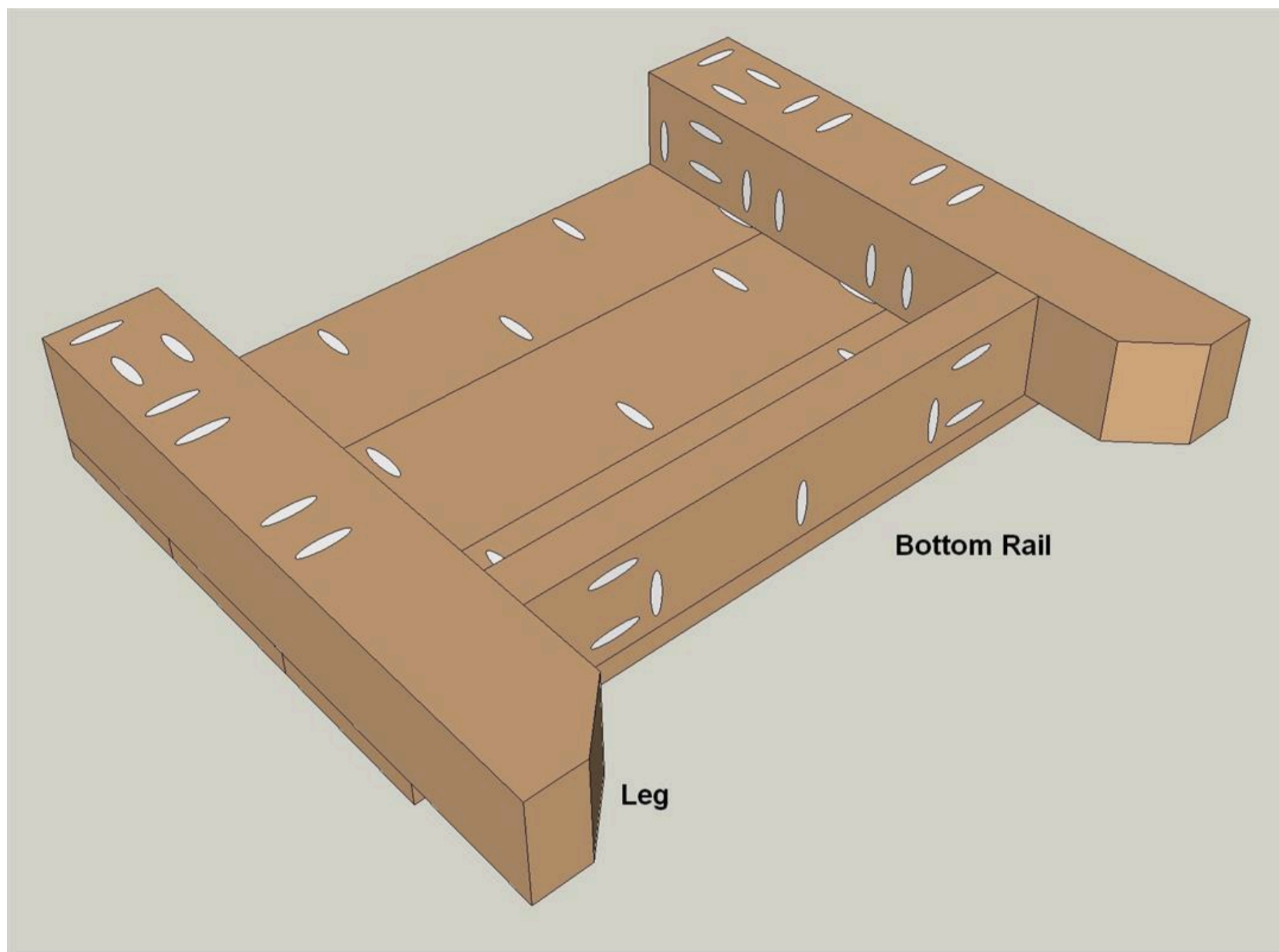

6**Join the Side Assemblies**

Join these two assemblies together by attaching the other two Bottom Rails using glue and 2 1/2" exterior-rated pocket-hole screws. Bar clamps can hold the parts in position as you drive in the screws.

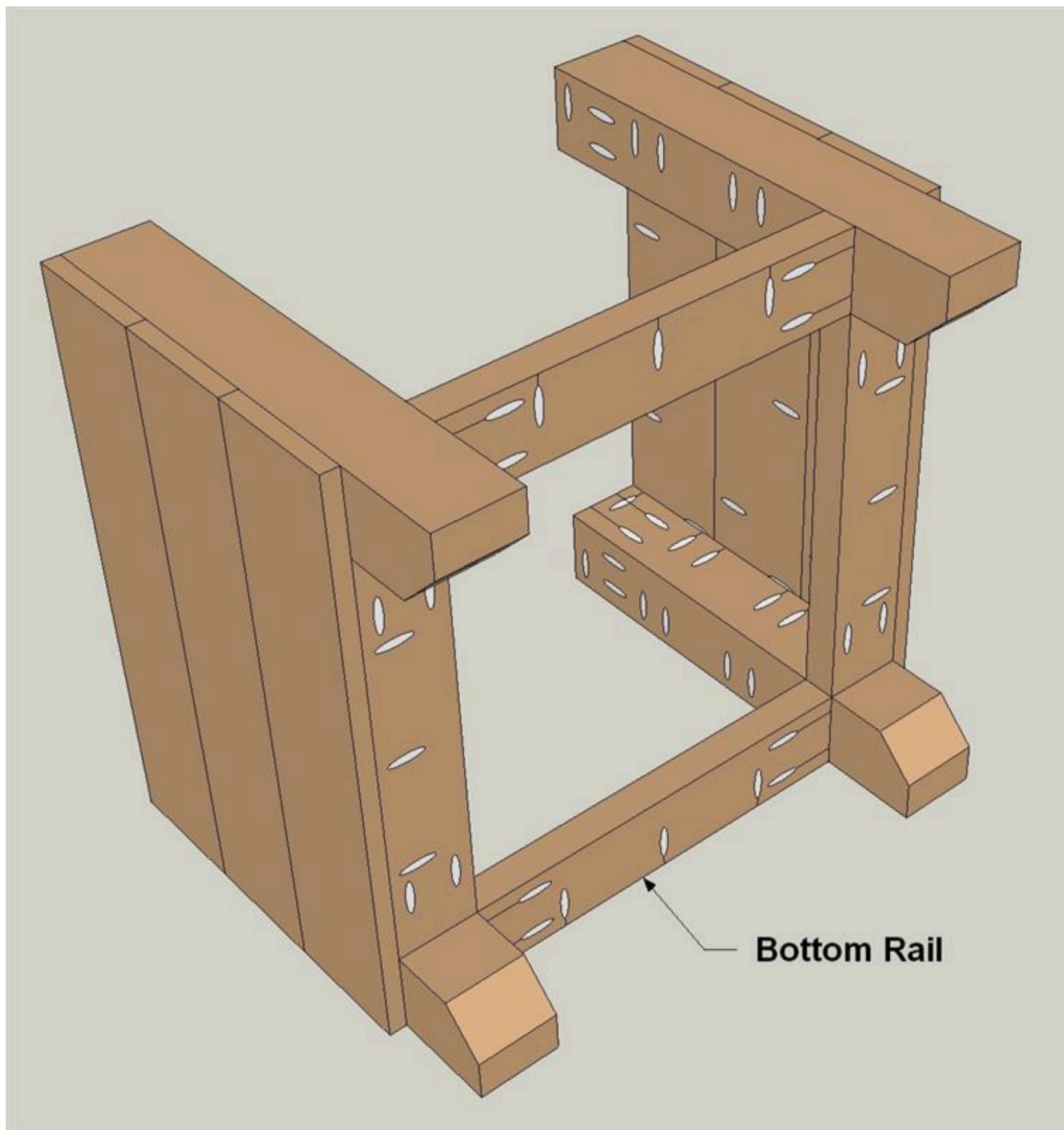

7**Create the End Slats**

Cut six End Slats to length from 1x6 boards, as shown in the cutting diagram. Then, with your pocket-hole jig set up for 3/4" material, drill pocket holes in the End Slats as shown.

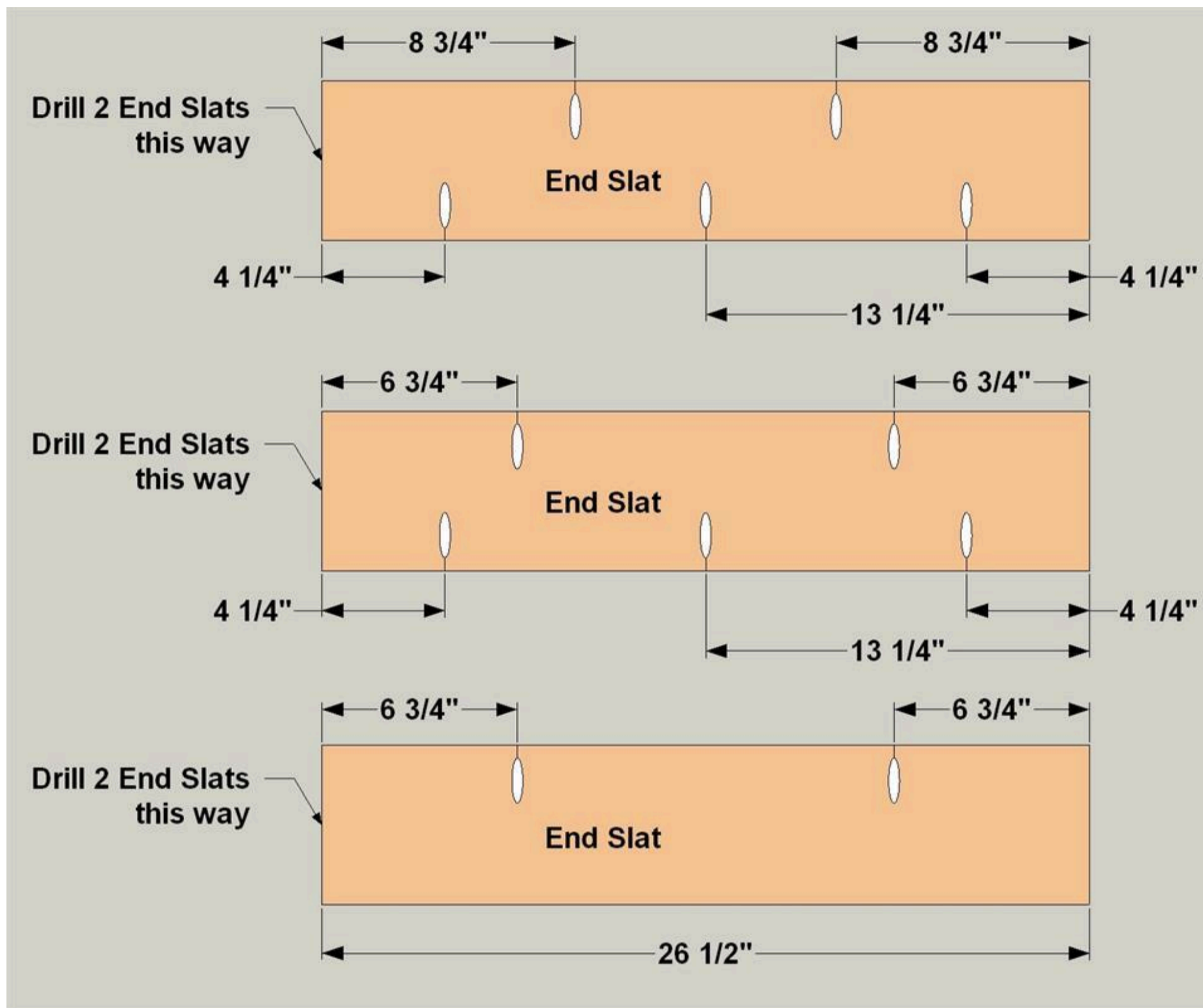

8**Assemble End Panels**

Create two end panels by joining Side Slats together as shown using 1 1/4" exterior-rated pocket-hole screws.

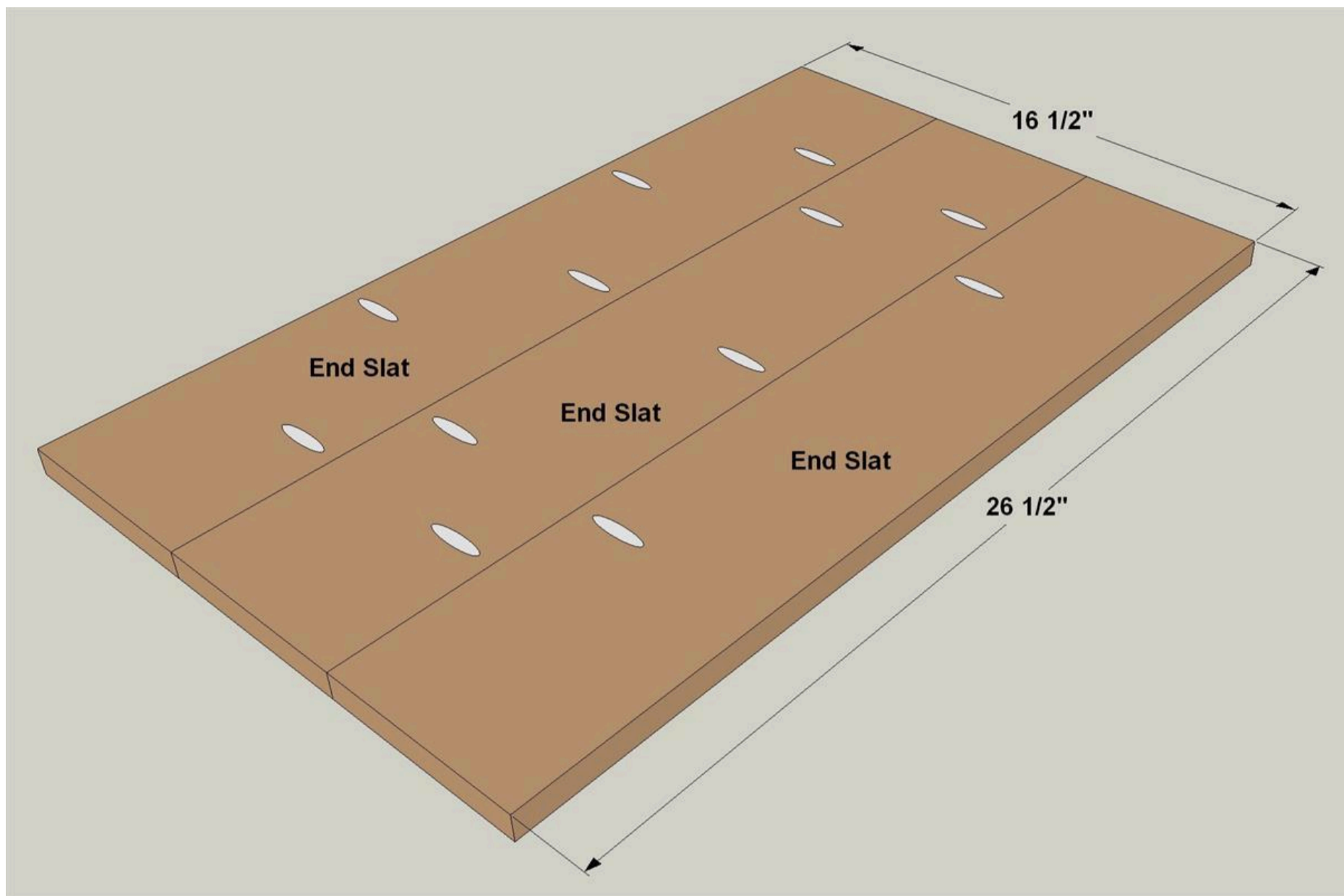

9**Attach the End Panels**

Attach them to the leg assemblies using glue and 1 1/4" exterior-rated pocket-hole screws. Make sure that the assemblies are square, and that the ends of the slats align with the faces of the side slats, which were attached earlier. Note that the slats get screwed to the Legs and to the Bottom Rails.

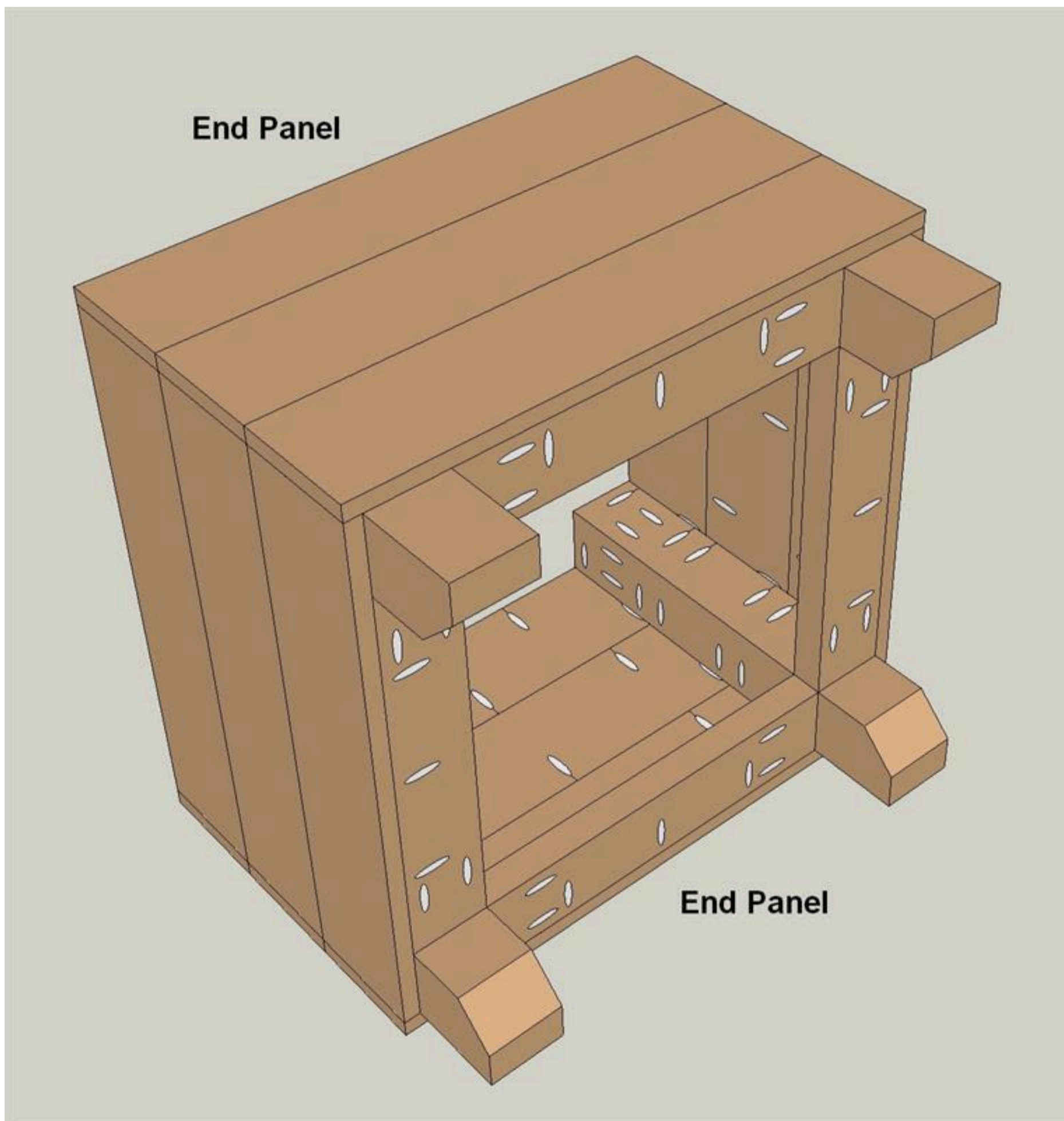

10**Cut the Curved Top Trim**

Cut two pieces of Long Top Trim and two pieces of Short Top Trim to length from 2x6 boards, as shown in the cutting diagram. Then lay out and cut the arcs in each piece using a jig saw. After that, drill pocket holes with the jig set up for 1 1/2" material.

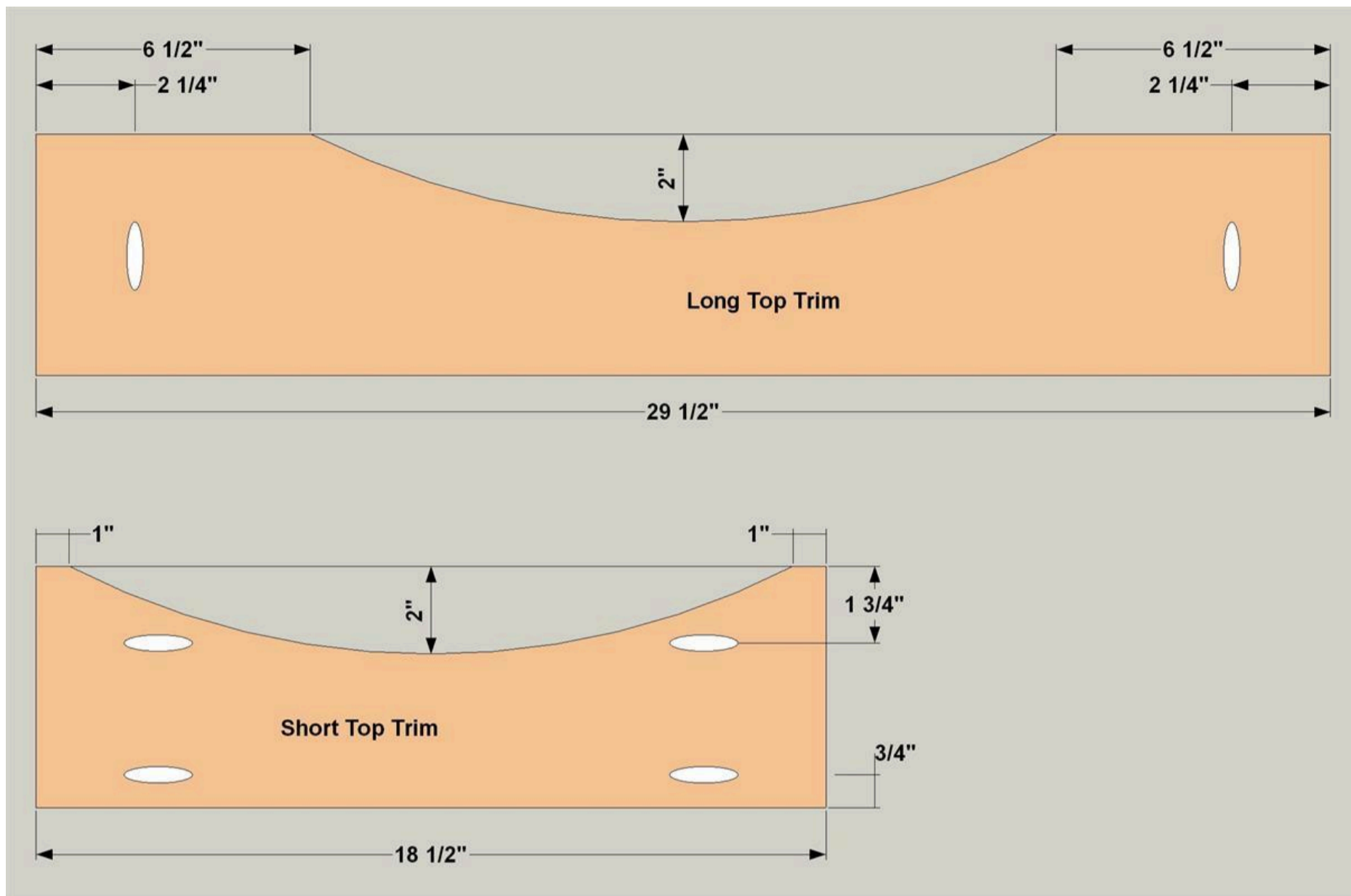

11

Join the Top Trim

Join the Long and Short Top Trim pieces together using 2 1/2" exterior-rated pocket-hole screws.

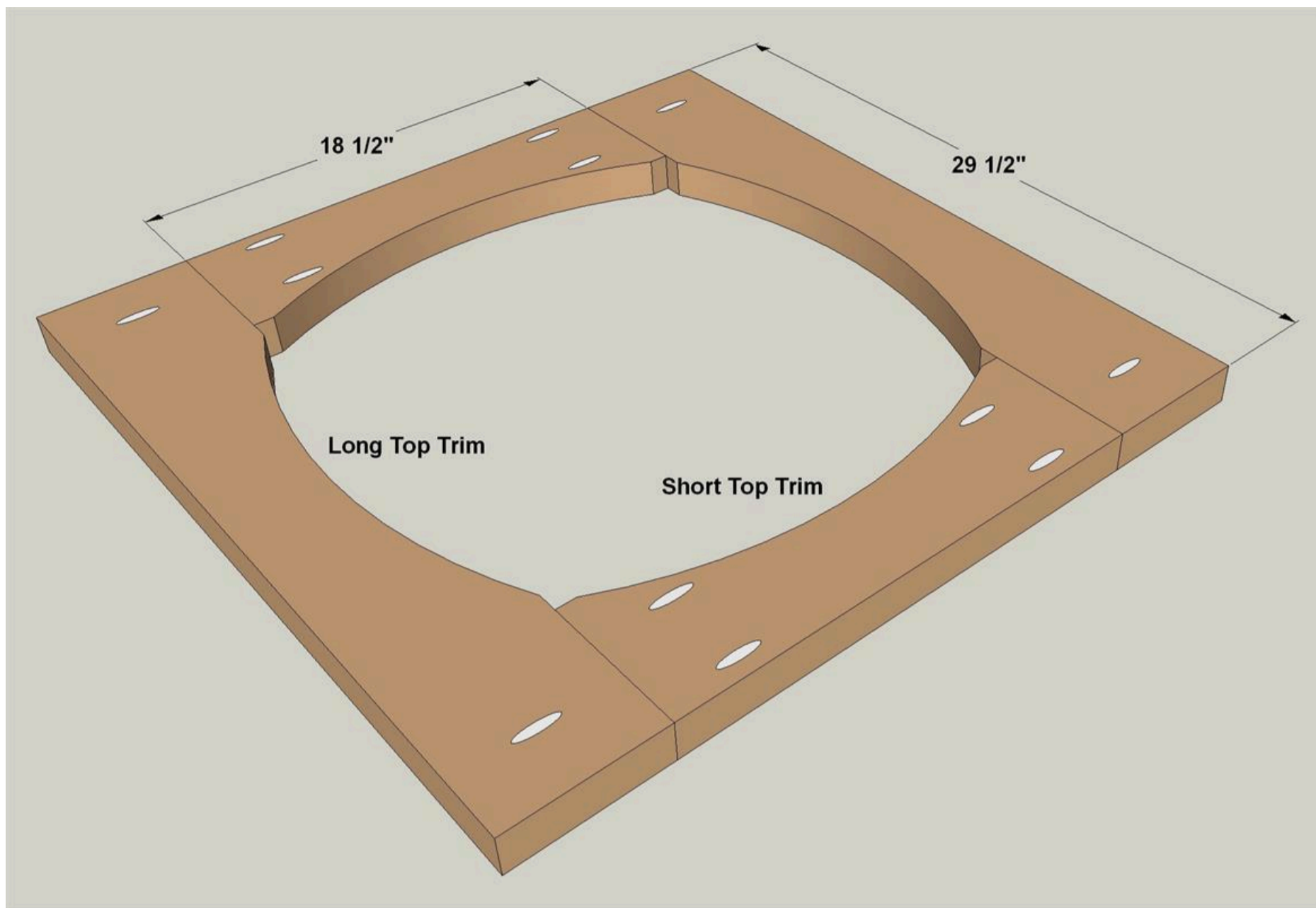

12**Attach the Top**

Attach the Top Trim to the assembled base using 1 1/4" exterior-rated pocket-hole screws. Make sure that the trim overhangs equally on all sides before driving in the screws.

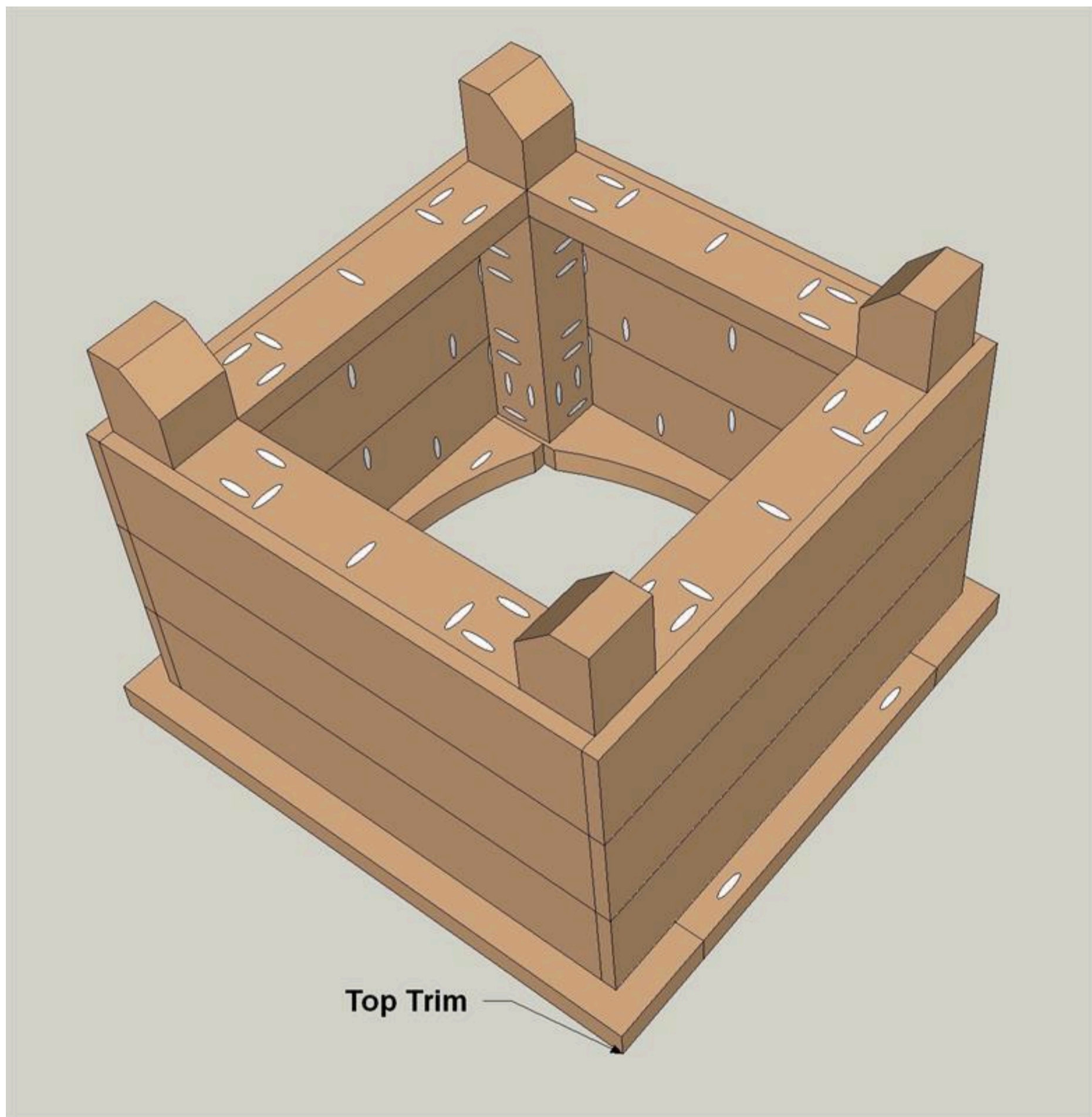

13

Add Edging

Cut eight pieces of Edge Trim to length from 1x2 boards, as shown in the cutting diagram. Then, attach the Edge Trim to the corners of the planter using 1 1/4" Exterior Brad Nails.

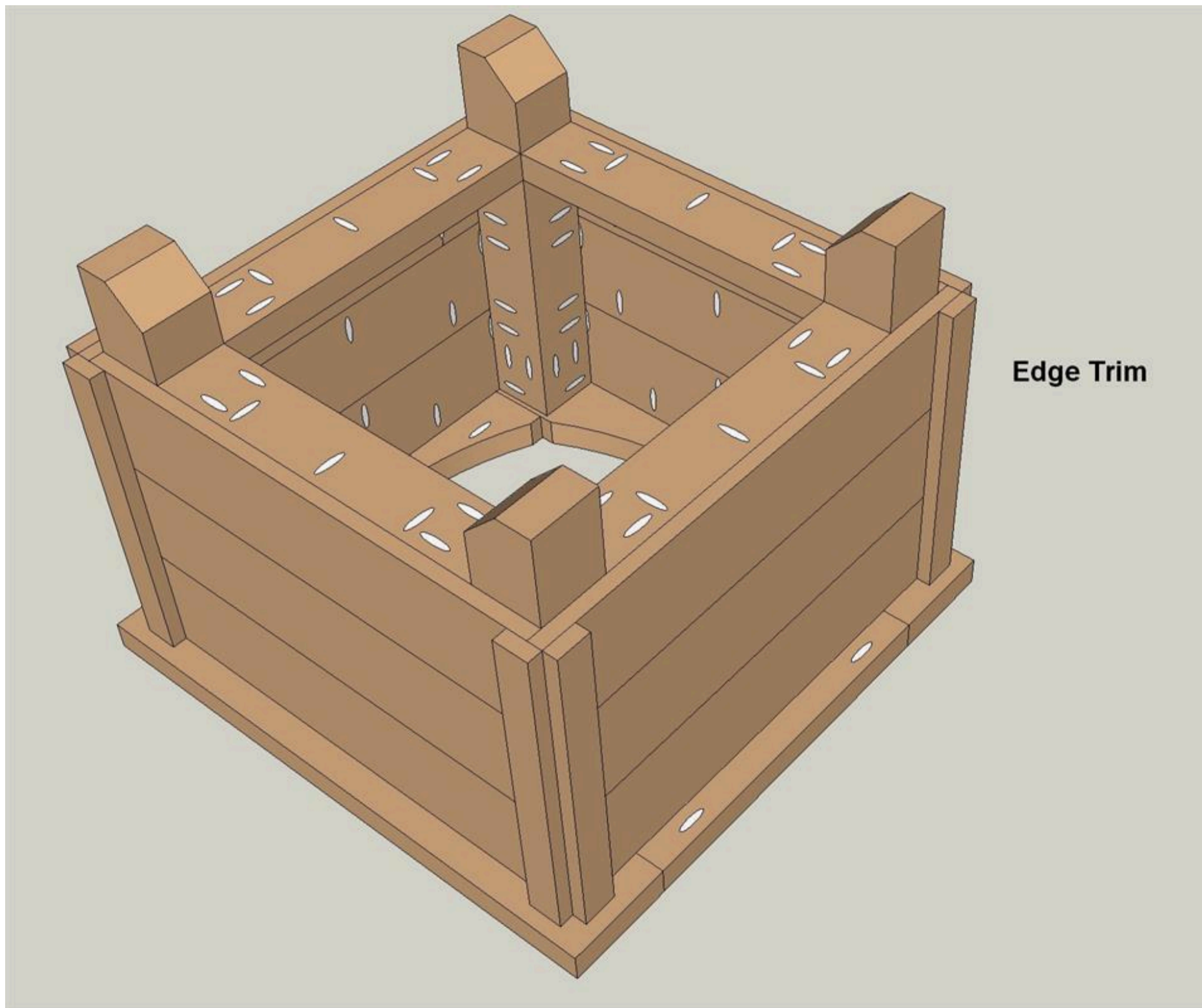

14**Make Bottom Slats**

Cut three Bottom Slats to length from a 2x6 board, as shown in the cutting diagram. With your pocket-hole jig set up for 1 1/2"-thick material, drill pocket holes in the Bottom Slats, as shown.

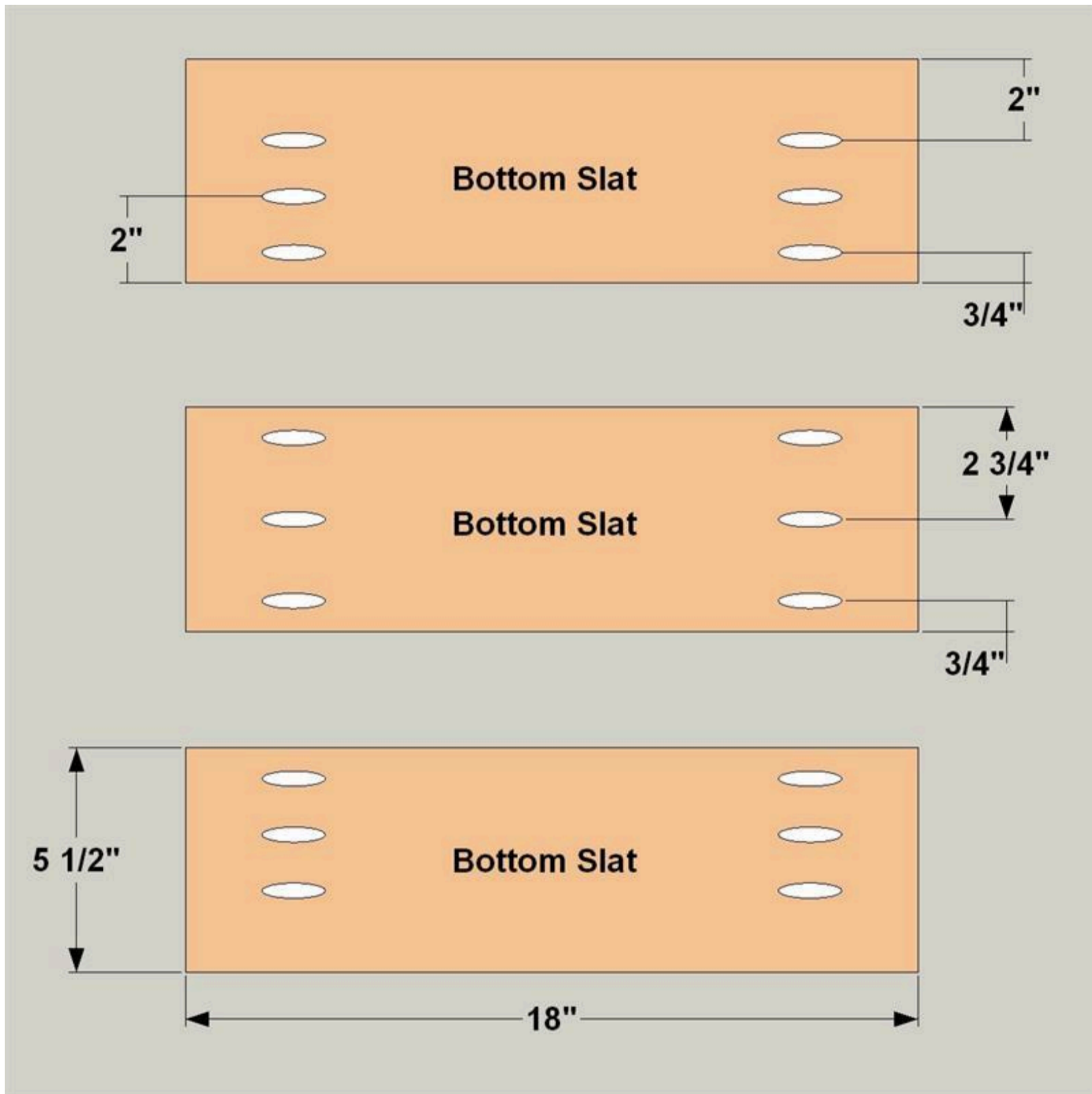

15

Attach the Bottom Slats and Finish

Attach the Bottom Slats to the Bottom Rails using 2 1/2" exterior-rated pocket-hole screws. Leave consistent gaps to allow water to drain out of the planter. With the Bottom Slats in, you can do any necessary sanding, and then protect your planter with a couple of coats of exterior stain or finish.

