

tall cupboard

By **Jaime Costiglio**

Difficulty

Moderate

A simple farmhouse style storage cabinet with fixed and movable shelves ready to handle anything you have to store. Use it in your office for all those extra papers and supplies, the dining room for easy access to dishes used less frequently, or the play room for all the kids games and toys.

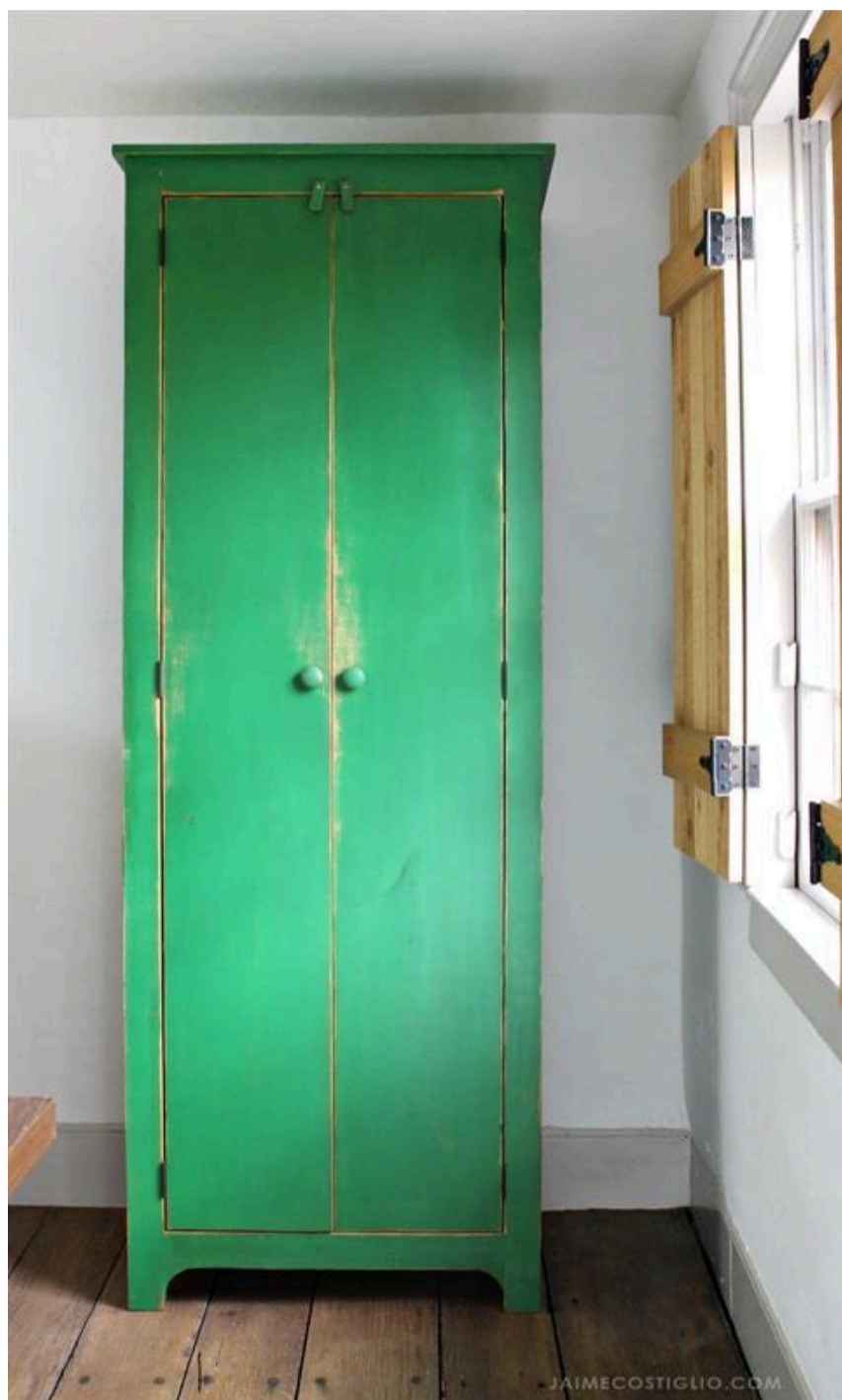



Tools

Kreg Tools



[Accu-Cut™](#)



[Rip-Cut™](#)



[Kreg® Pocket-Hole Jig 720](#)



[Shelf Pin Jig with 1/4" Bit](#)

Other Tools

Circular Saw (cordless)

Jigsaw

Miter Saw

Tape Measure

Drill (cordless)

Nail Gun

Sander

Materials

Wood Products

2 Plywood , 3/4" Thick , Full Sheet

3 Board , 1x3 , 96"

1 Board , 1x5 , 72"

2 Board , 1x12 , 72"

5 Tongue & Groove , 1x6 , 96"

Hardware & Supplies

50 1 1/4" Pocket Hole Screws

25 1 1/4" Wood Screws

50 1 1/4" Finish Nails

6 Full Wrap Hinges

2 Knobs

Cut List & Parts

- 2 Sides , 3/4" X 77 1/4" X 17 1/4"
- 3 Top, Middle, Bottom , 3/4" X 16 1/2" X 26 3/8"
- 1 Top , 3/4" X 18 3/4" X 29 3/8"
- 3 Movable Shelves , 3/4" X 16 1/2" X 26"
- 2 Long Trim , 1 X 3 @ 77 1/4"
- 1 Top Trim , 1 X 3 @ 22 7/8"
- 1 Bottom Trim , 1 X 5 X 22 7/8"
- 5 Backing , 1 X 6 @ 72 1/2"
- 2 Doors , 1 X 12 @ 69"
- 6 Door Support , 1 X 3 @ 8 1/4"







Directions

1

dimensions

overall dimensions: 78"h x 29 3/8"w x 18 3/4"d

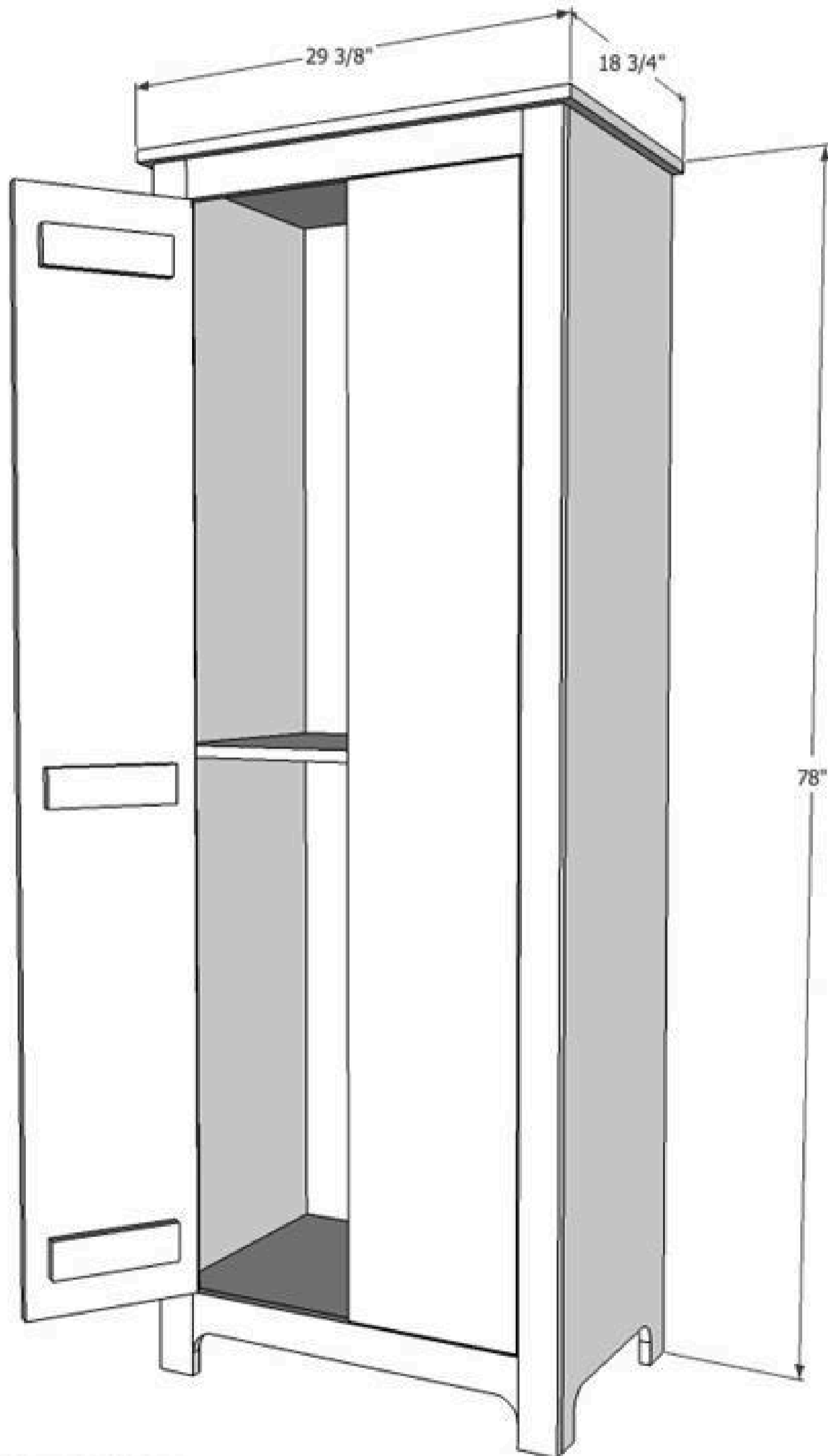

TALL CUPBOARD

JAIMECOSTIGLIO.COM

2

step 1

Step 1: Build the carcass. Attach the top, middle shelf and bottom to the sides using wood glue and 1 1/4" pocket hole screws. In the top and bottom be sure to predrill pocket holes for later attaching the face frame.

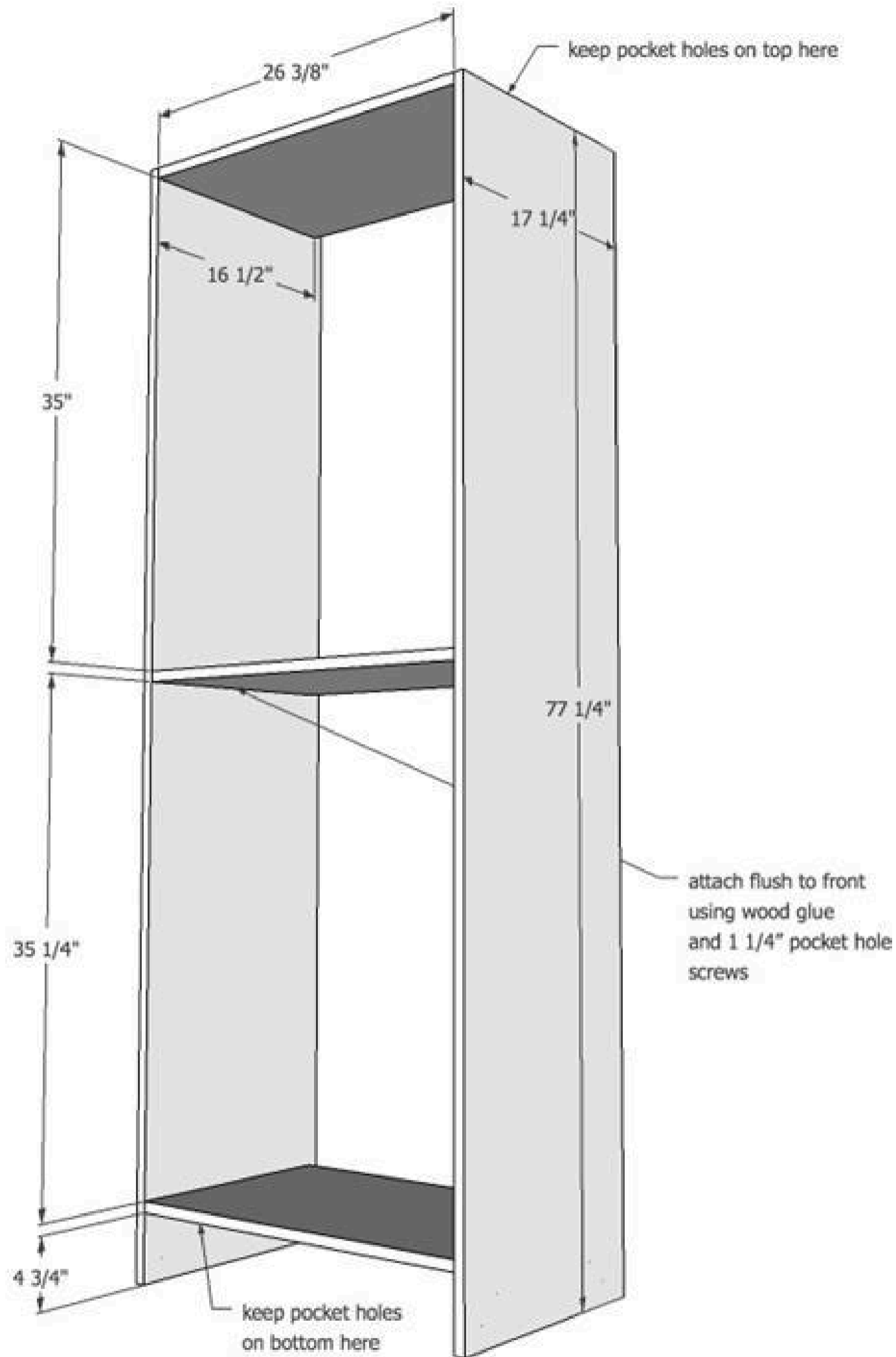

TALL CUPBOARD STEP 1

3

step 2

Step 2: Construct the face frame. Attach the short trim pieces to the long trim using wood glue and 1 ¼" pocket hole screws.

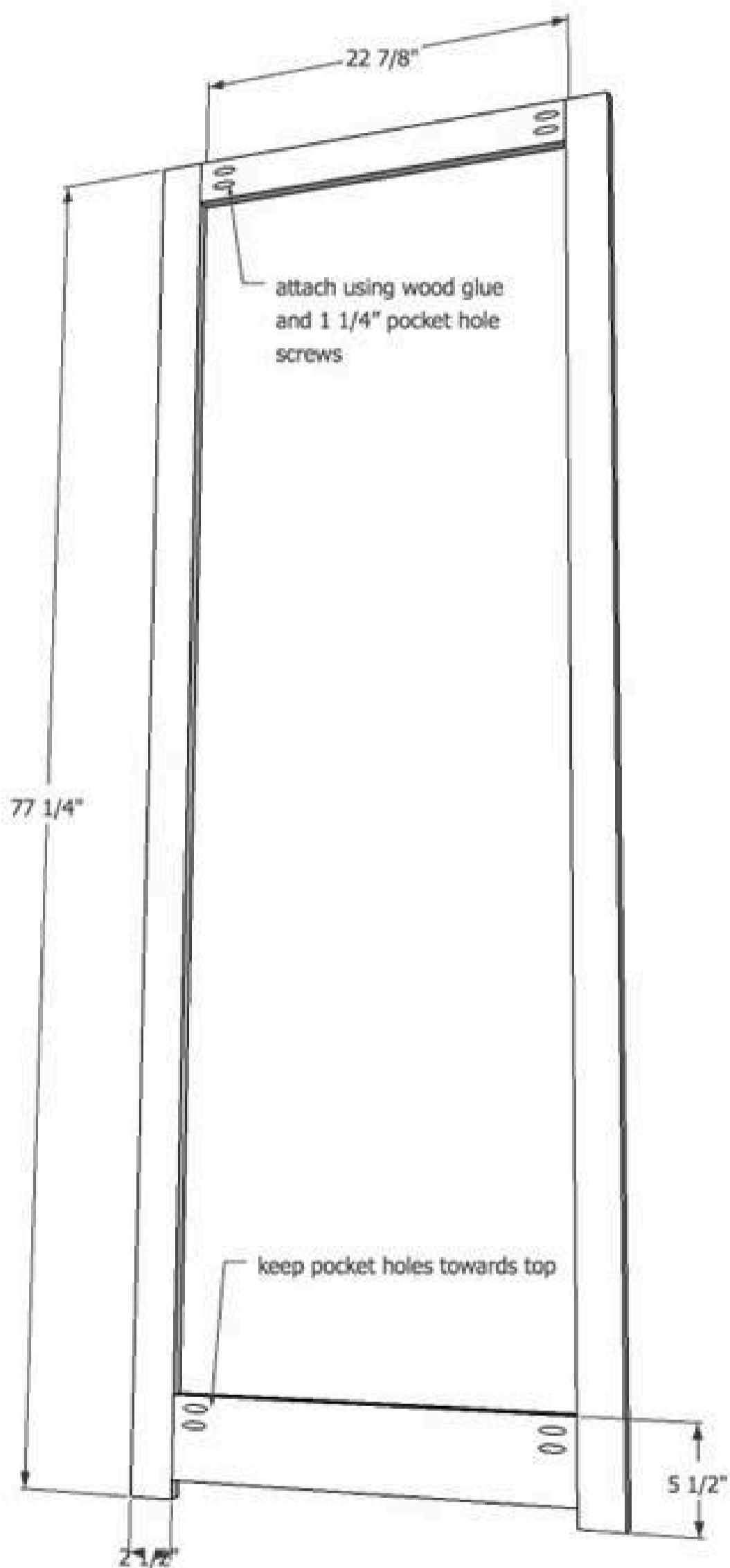

TALL CUPBOARD STEP 2

4

step 3

Step 3: Attach face frame to carcass using predrilled pocket holes. Use wood glue and 1 1/4" pocket hole screws plus 1 1/4" finish nails on the sides

JAIMECOSTIGLIO.COM

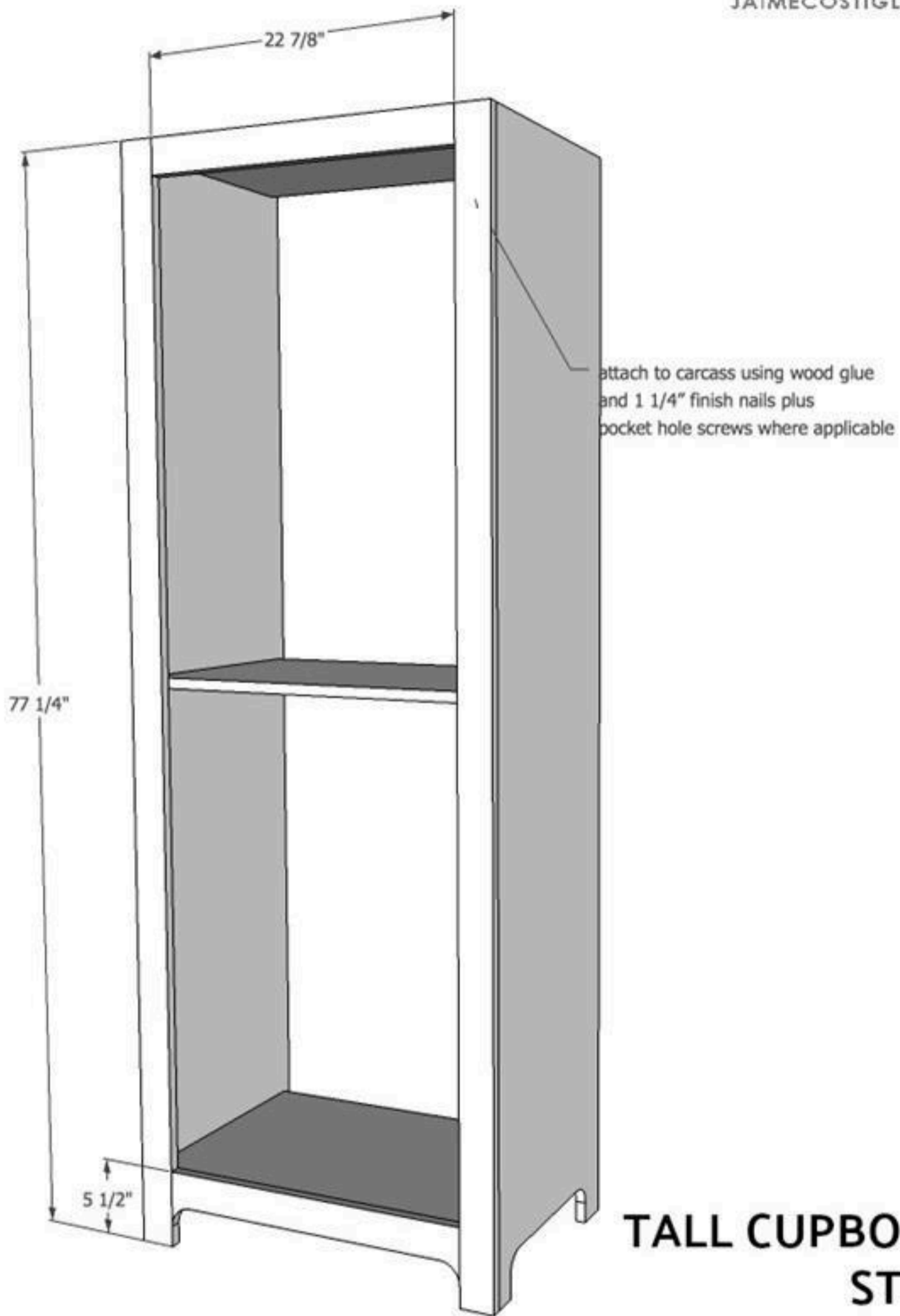

**TALL CUPBOARD
STEP 3**

5

step 4

Step 4: Use a jigsaw to cut decorative curved trim at bottom.

TALL CUPBOARD

STEP 4

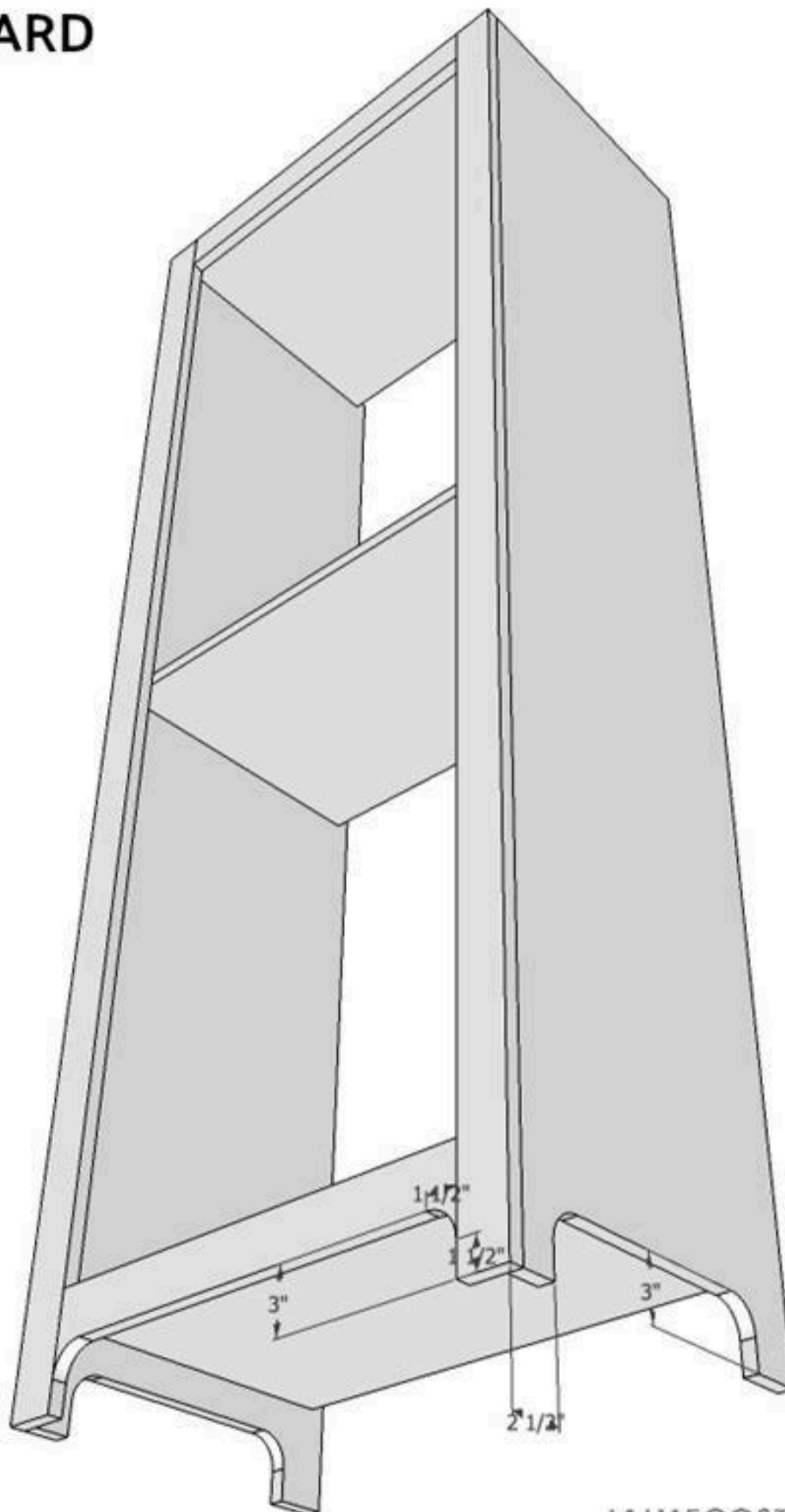

JAIMECOSTIGLIO.COM

6

step 5

Step 5: Attach the top the to carcass using wood glue and countersunk 1 1/4" wood screws. Keep top flush at back sides and 3/4" overhang on front and sides.

**TALL CUPBOARD
STEP 5**

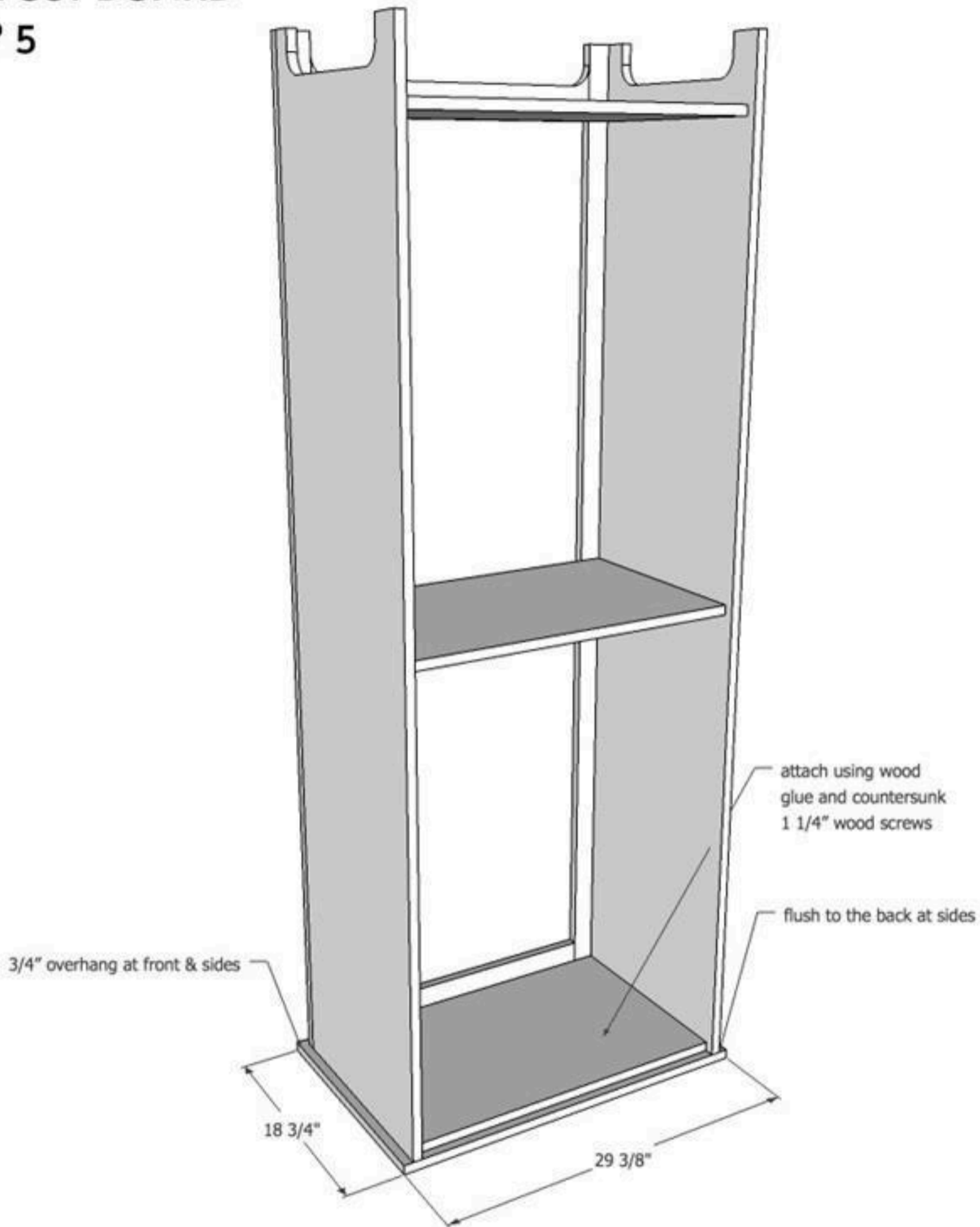

JAIMECOSTIGLIO.COM

7

step 6

Step 6: Layout tongue and groove backing pieces. Assure equal spacing and secure using wood glue and 1 1/4" countersunk wood screws.

TALL CUPBOARD STEP 6

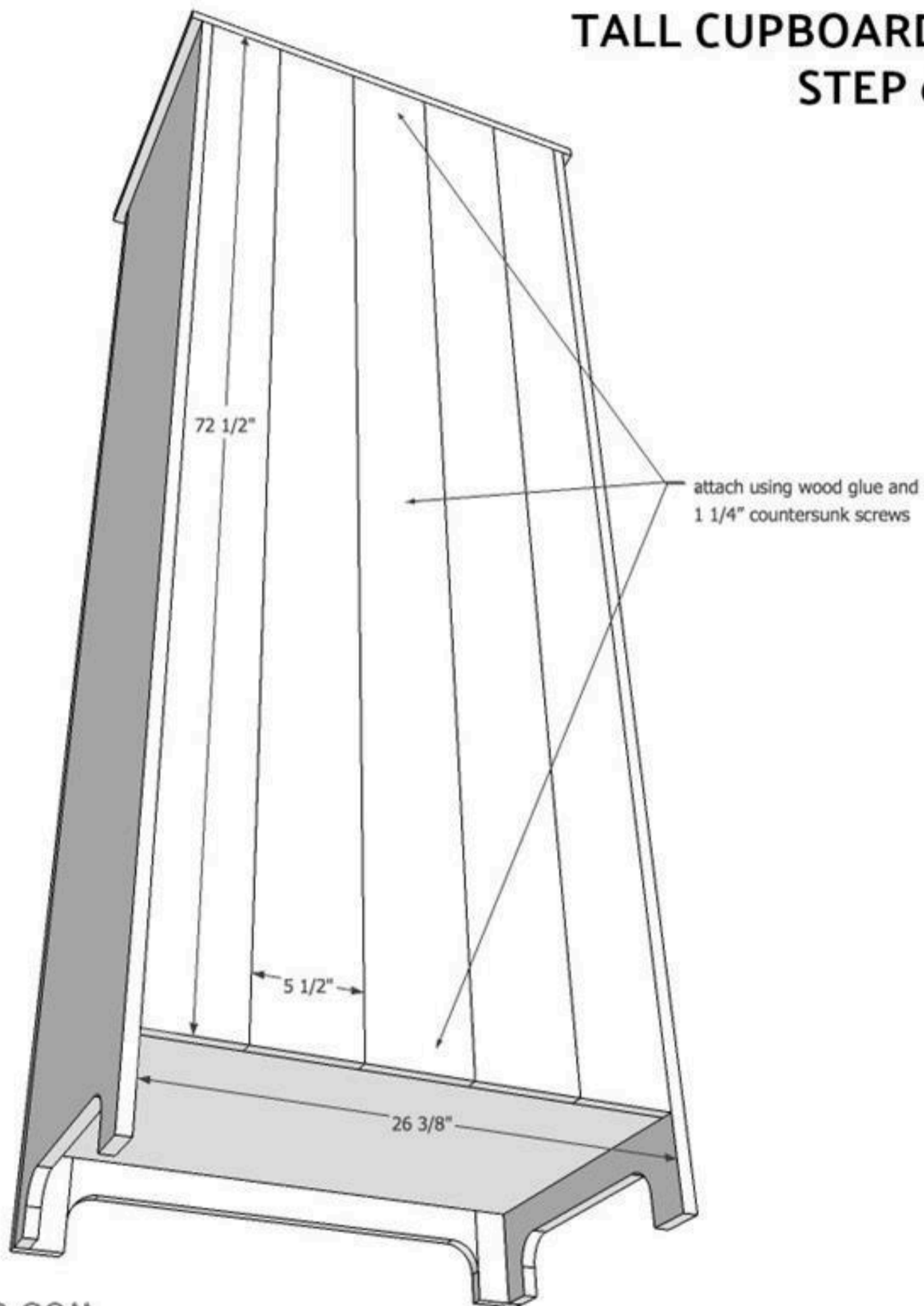

JAIMECOSTIGLIO.COM

8**step 7**

Step 7: Make doors. Attach cross supports to door interior using wood glue and 1 ¼" finish nails. Check middle shelf placement before attaching middle cross support, support must be attached either above the middle shelf or below in order for door to close properly.

TALL CUPBOARD

STEP 7

