

# Murphy Grill Station

By **Castor Woodworks**

Difficulty

Easy

This fold down storage cabinet is a great place to store all your grill tools and accessories.

It features Wallcontrol pegboard and Weatherwash stain.

It folds up when not in use and is a great centerpiece for any outdoor grilling area!

[www.instagram.com/castor\\_woodworks](http://www.instagram.com/castor_woodworks)

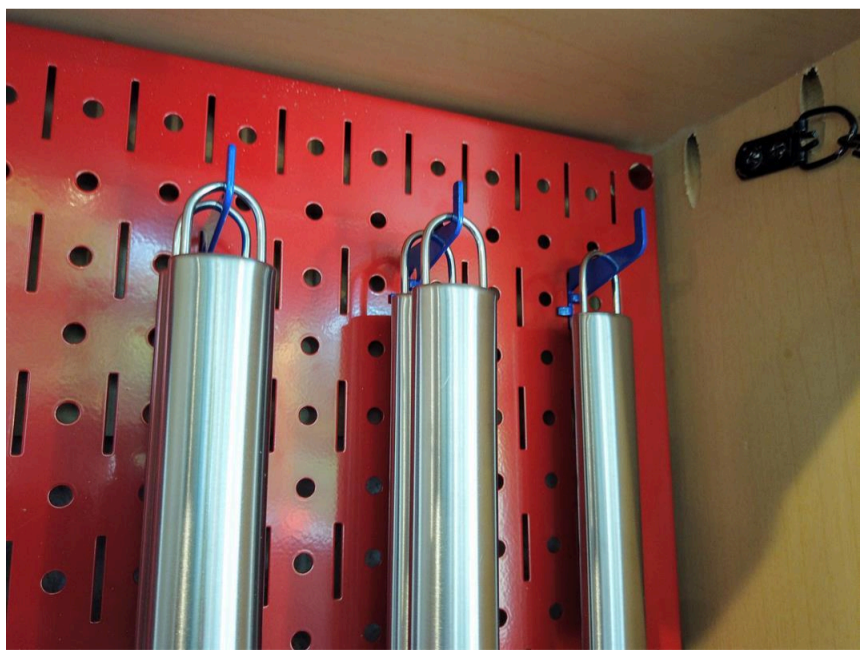
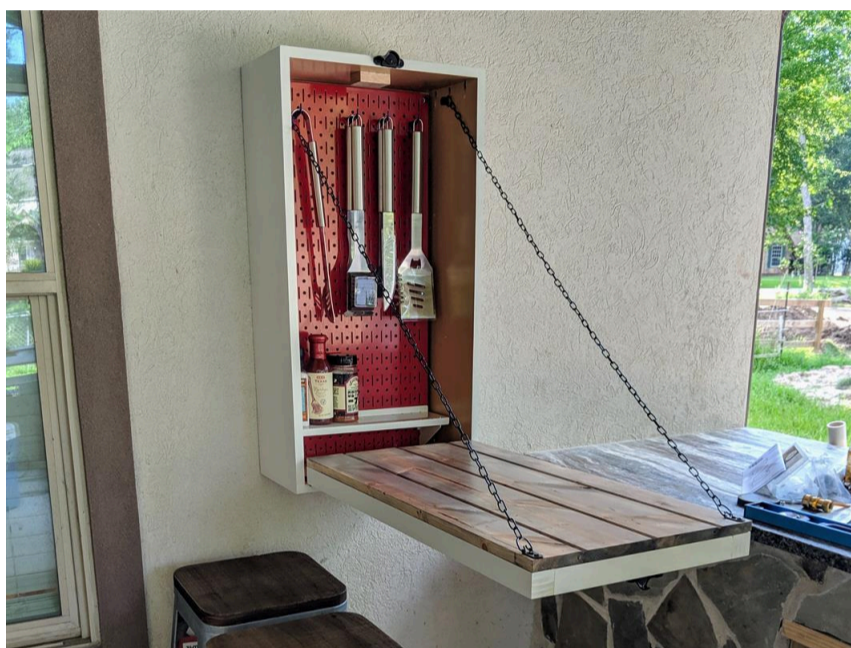
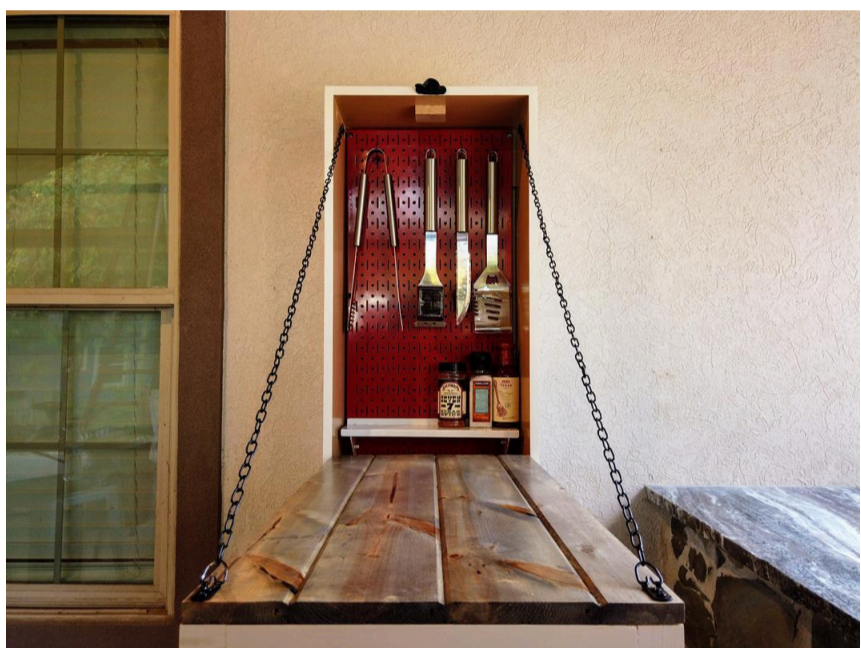



# Tools

## Other Tools

Miter Saw

Square

Table Saw

Track Saw

Sander

Tape Measure

# Materials

## Wood Products

**1** Select Pine Board , 2x2 , 96"

**1** Plywood , 3/4" Thick , Half Sheet

## Hardware & Supplies

**1** WallControl Vertical Panel

**1** WeatherWash: RUSTED Aging Stain Quart Size

**50** 2" Pocket Screws

**15** 1 1/4" Pocket Screws

**1** Primer

**1** Paint

**2** 3" Strap Hinge

**1** Window Sash Lock

**1** Decorative Black Chain

# Cut List & Parts

- 2 Sides , 3/4" X 9" X 34"
- 2 Top And Bottoms , 3/4" X 9" X 16.5"
- 3 Table Top Boards , 3/4" X 5.5" X 32.25"
- 2 Big Frame Stiles , 1 1/2" X 1 1/2" X 32.25"
- 2 Big Frame Rails , 1 1/2" X 1 1/2" X 13.25"
- 2 Small Frame Stiles , 1 1/2" X 1 1/2" X 29"
- 2 Small Frame Rails , 1 1/2" X 1 1/2" X 10"

# Directions

1

## Complete Cut List

Use the cut-list to break down 3/4" plywood to the specified dimensions. You could also use MDF just make sure you the stock you use is nice and flat.

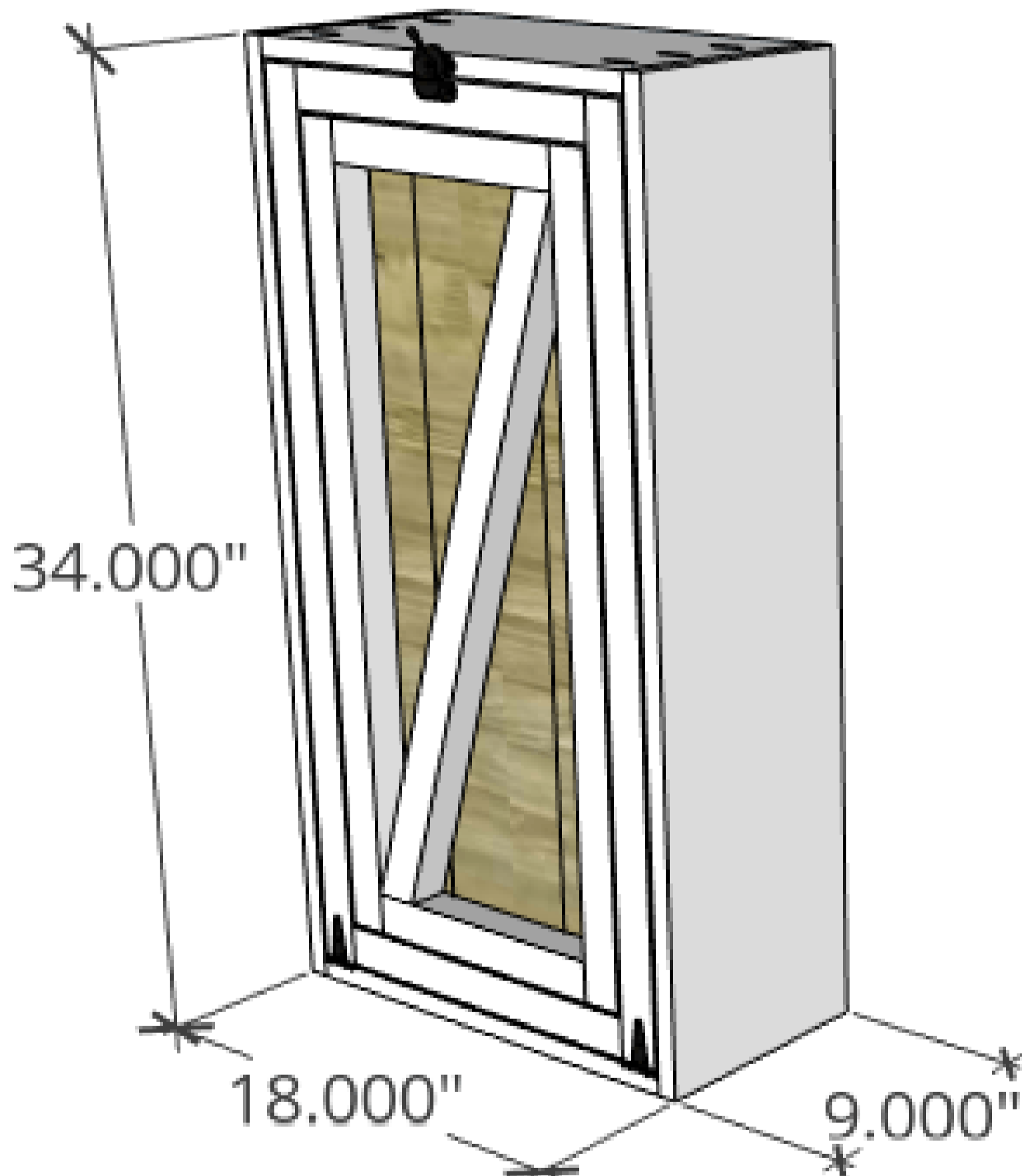

**2****Drill Pocket Holes**

Drill pocket holes on each end of the top and bottom pieces. Do the same for the cleat and bottom support but make sure to add pocket holes to the top of the cleat as well.

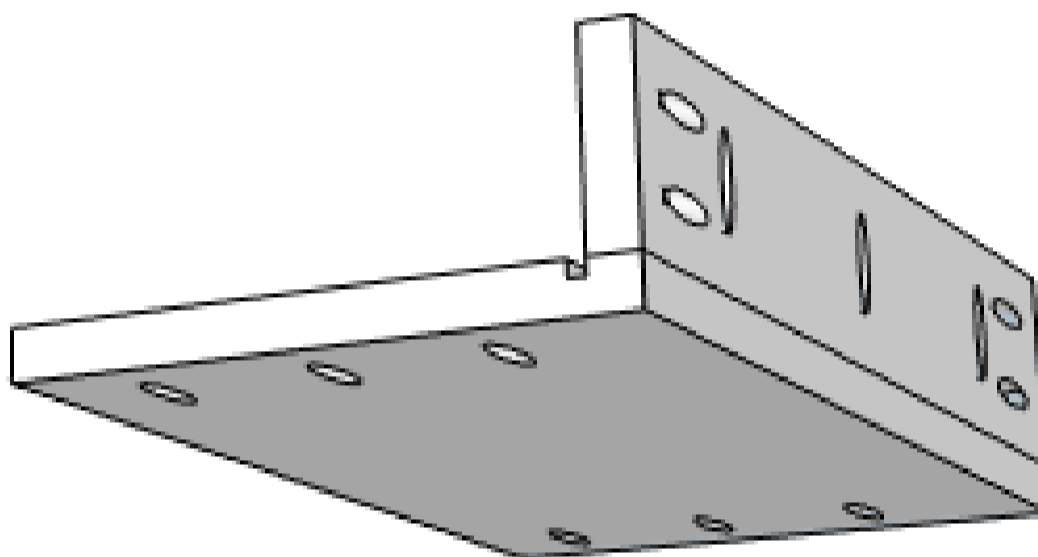

**3****Assemble Cabinet**

Attach the Sides to the Top and Bottom pieces uses pocket screws. Make sure the joints are square during assembly.

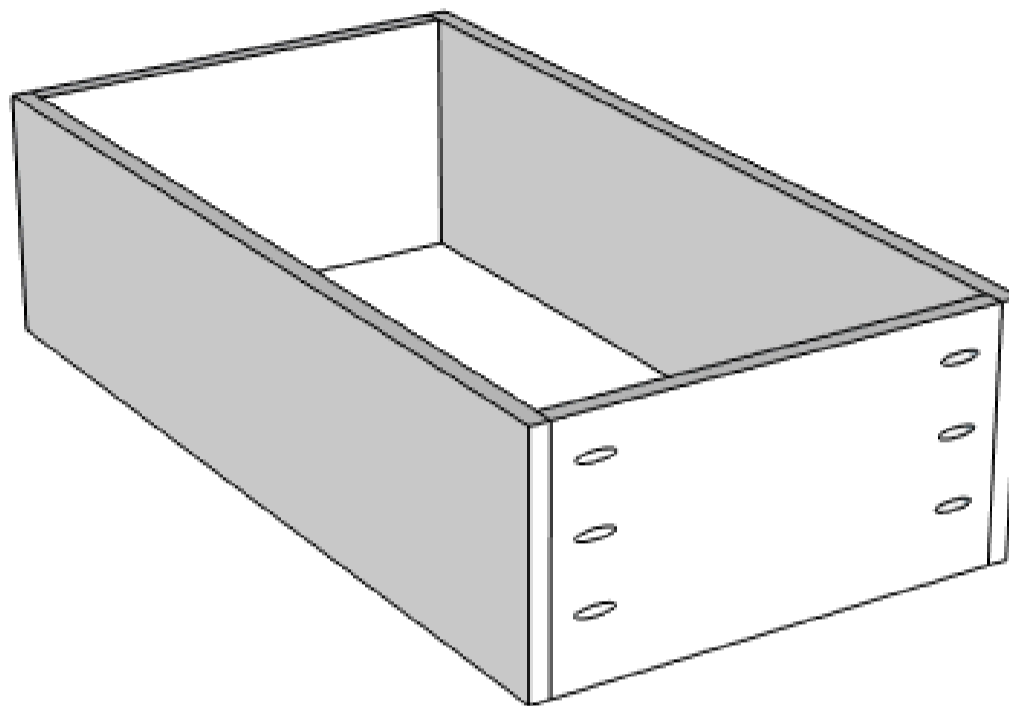

4

#### Attach Cleat and Stretcher

Secure the Top and cleat to the Sides with pocket screws. Attach the Bottom Stretcher to the Bottom and Sides as well.

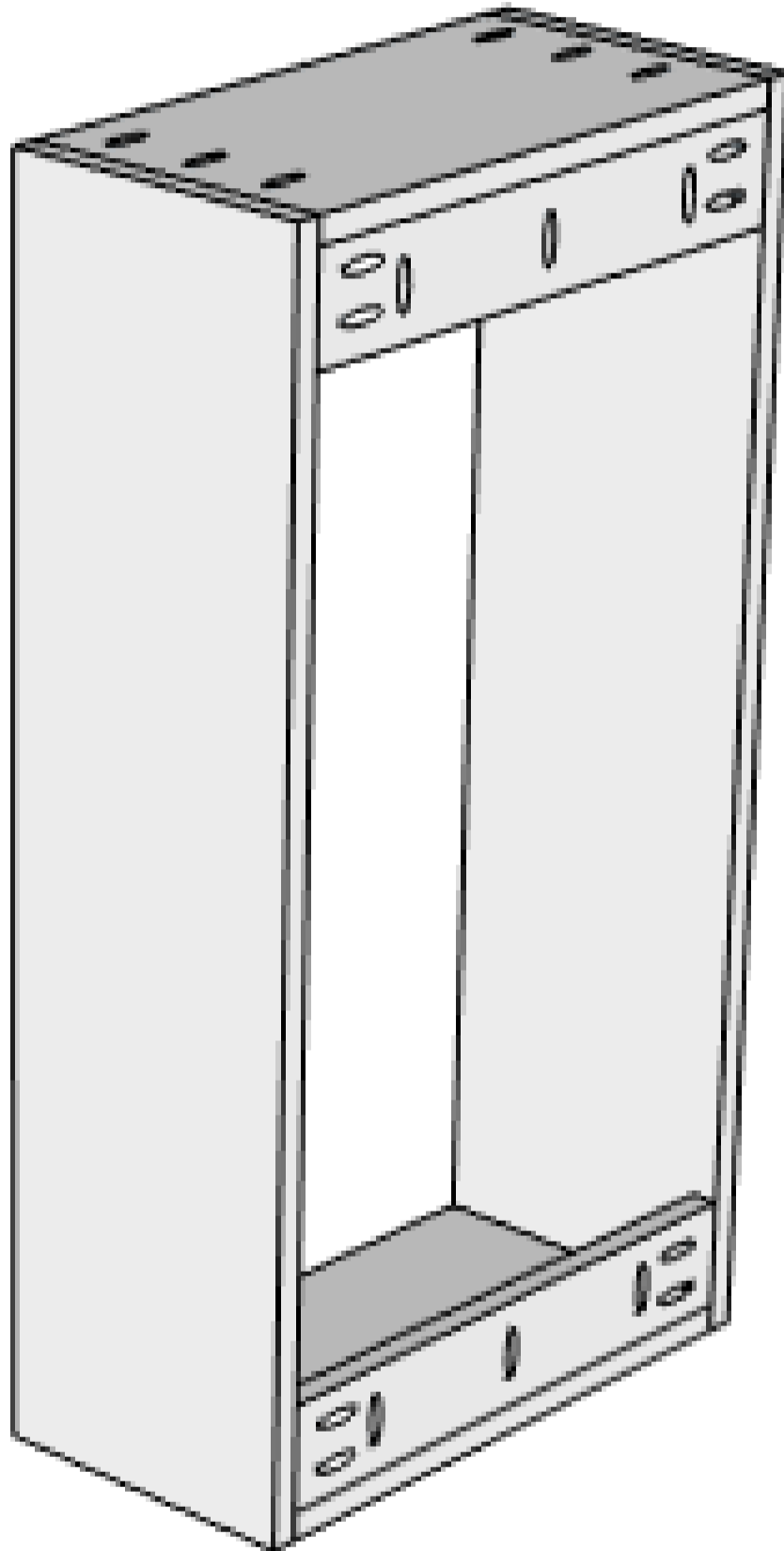

**5**

**Attach Wall Control Panel**

Attach the panel using 5/8" pan head screws.

---



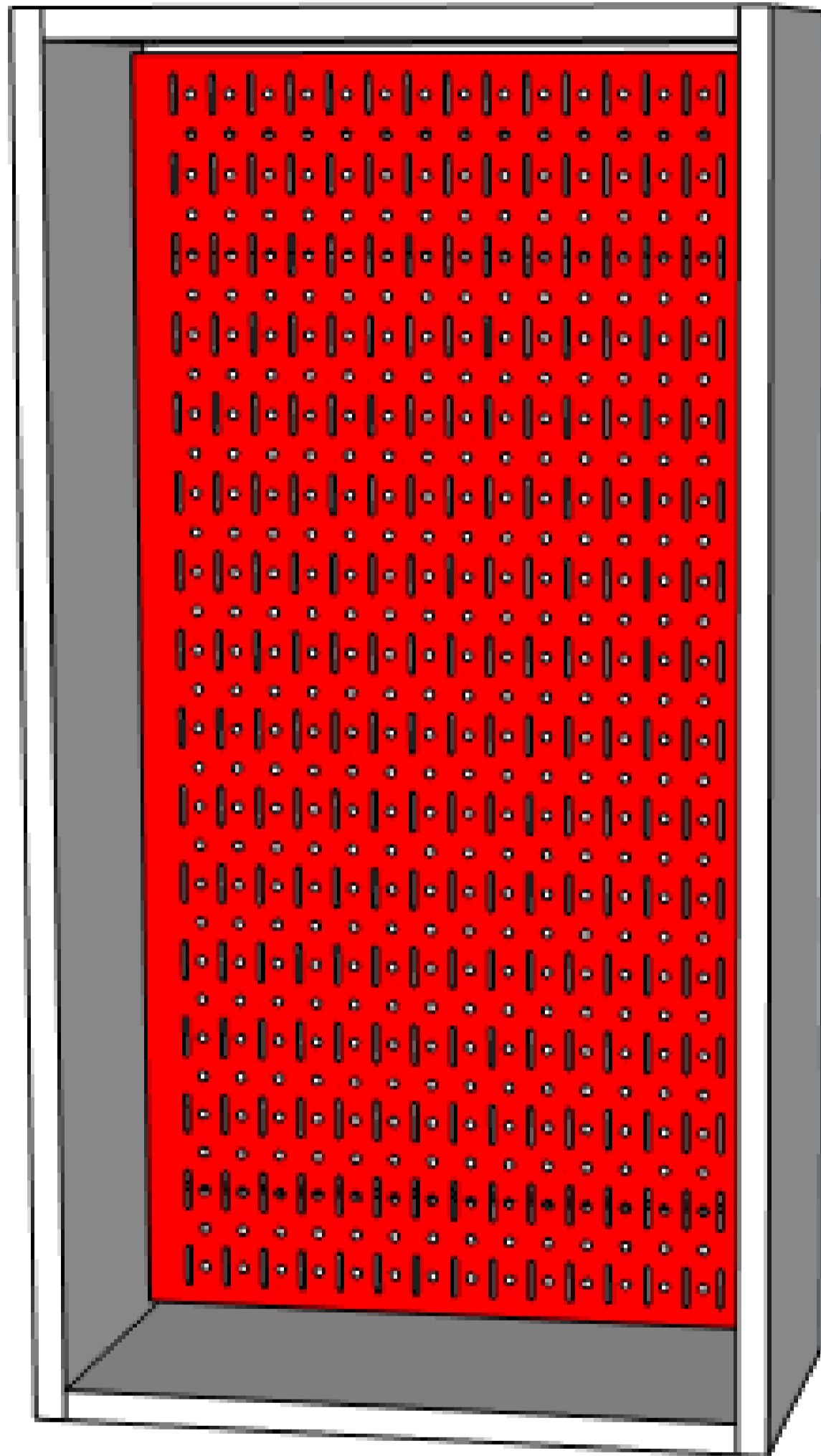

6

### Glue up Table Top

Glue your 1x6's together to form your Table Top. You can use biscuits too or even pocket screws to make the top.

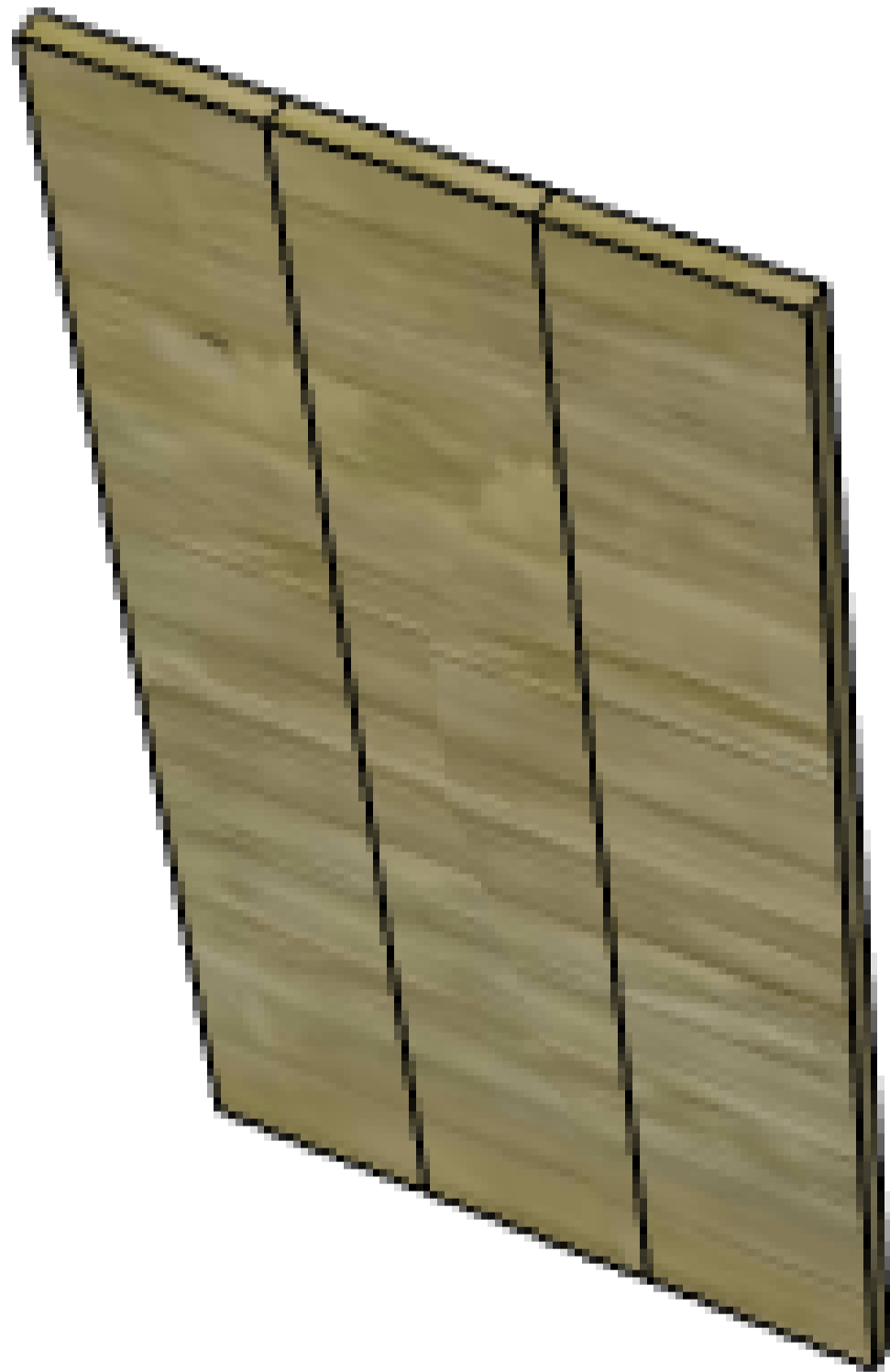

**7****Assemble Frames**

Assemble your big and little frames using 2" pocket screws.

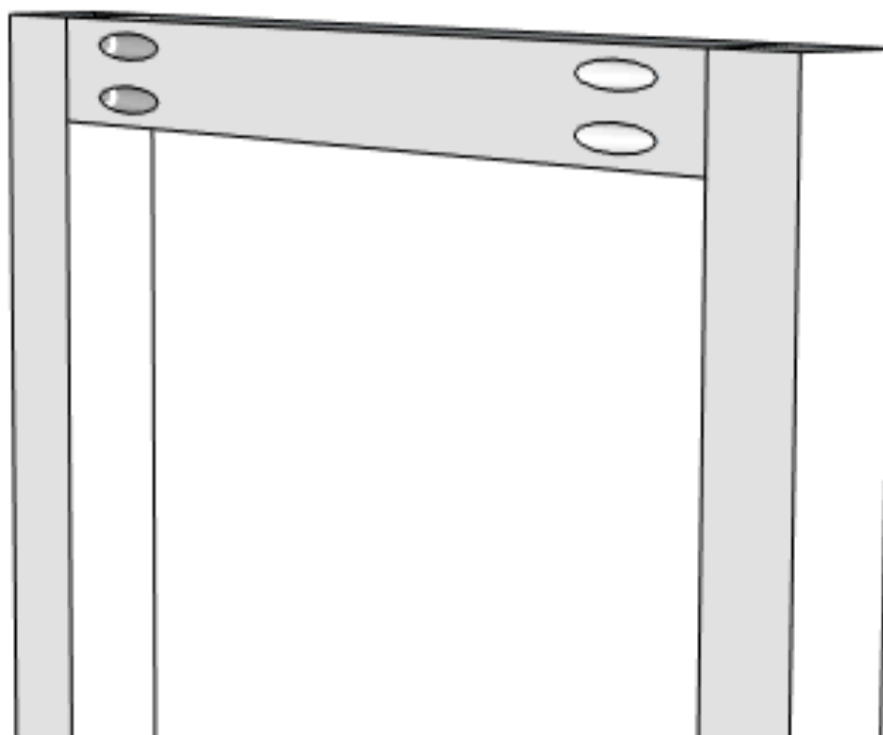
**8****Prep for Painting**

Sand your Cabinet, Small & Big frame and Table Top down to 150 grit.

**9****Paint Cabinet and Frames**

Paint your Cabinet and Frames using an airless or HVLP sprayer. You could also paint them by hand.

**10****Apply Weatherwash**

Apply weather wash using a foam brush. You can do two coats for a richer color.

11

**Put it all together!**

Attach the Table top to the big frame using glue and brad nails.

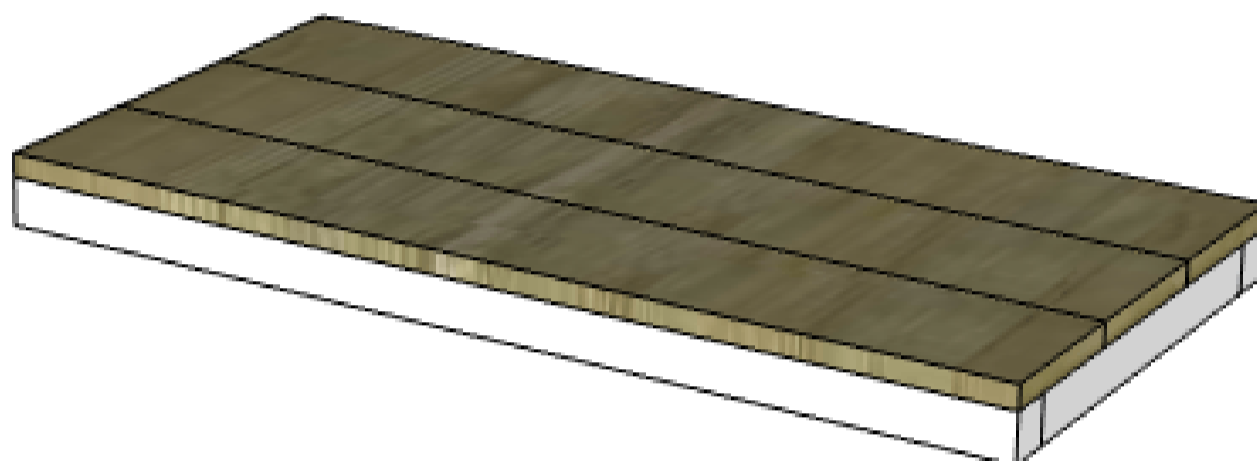

**12****Attach Hinges**

Attach the Hinges to the Cabinet first. Then clamp the Big frame to the cabinet using 1/8" spacers and screw in your hinges to the frame. This should give you equal spacing when you open and close the door.

---

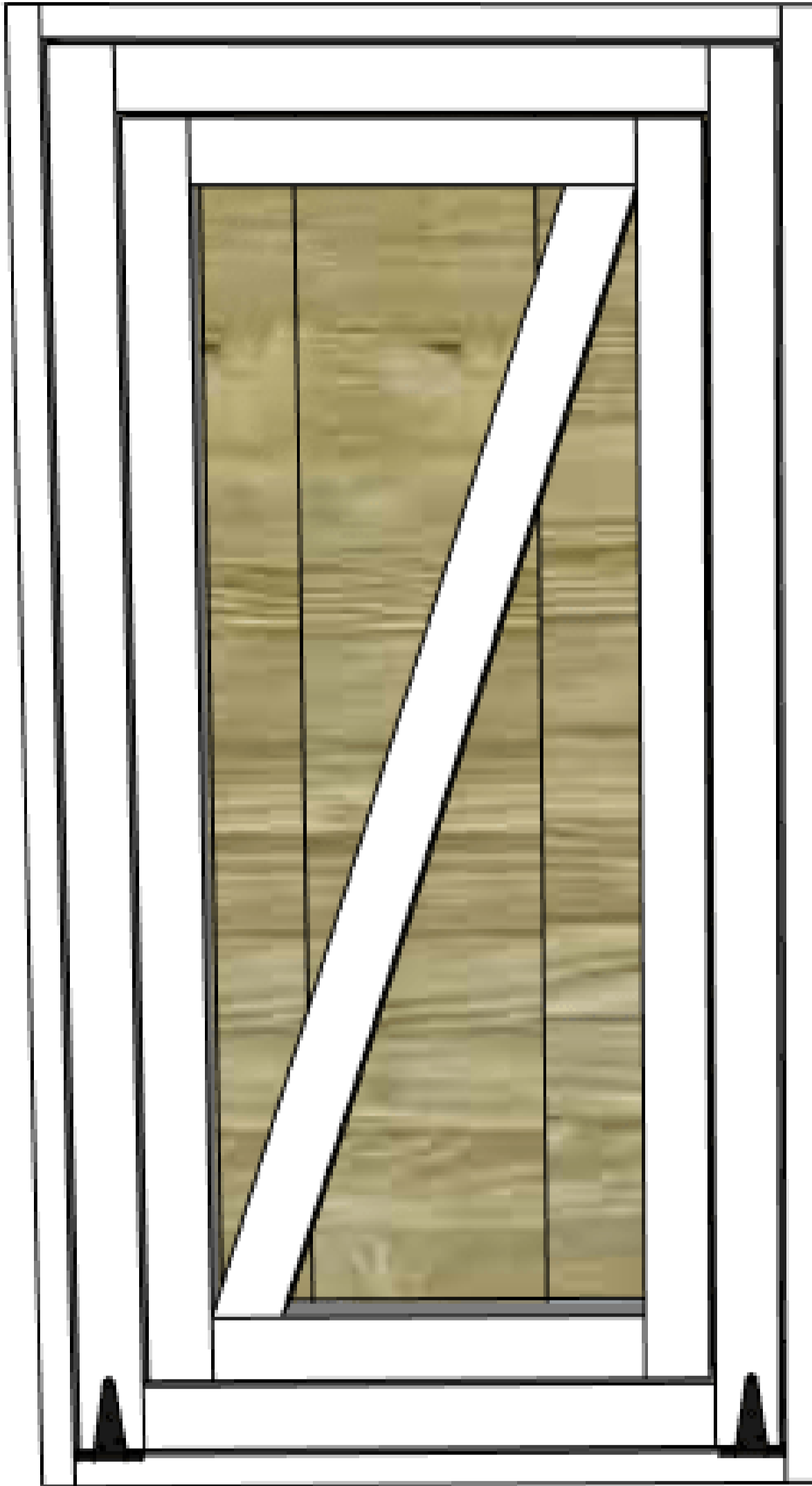



13

### Mount on wall

Mount the Wall Cleat to your wall using a couple of 3" screws. The cleat should be about 72" off the ground so that the top will be about counter-height when open.

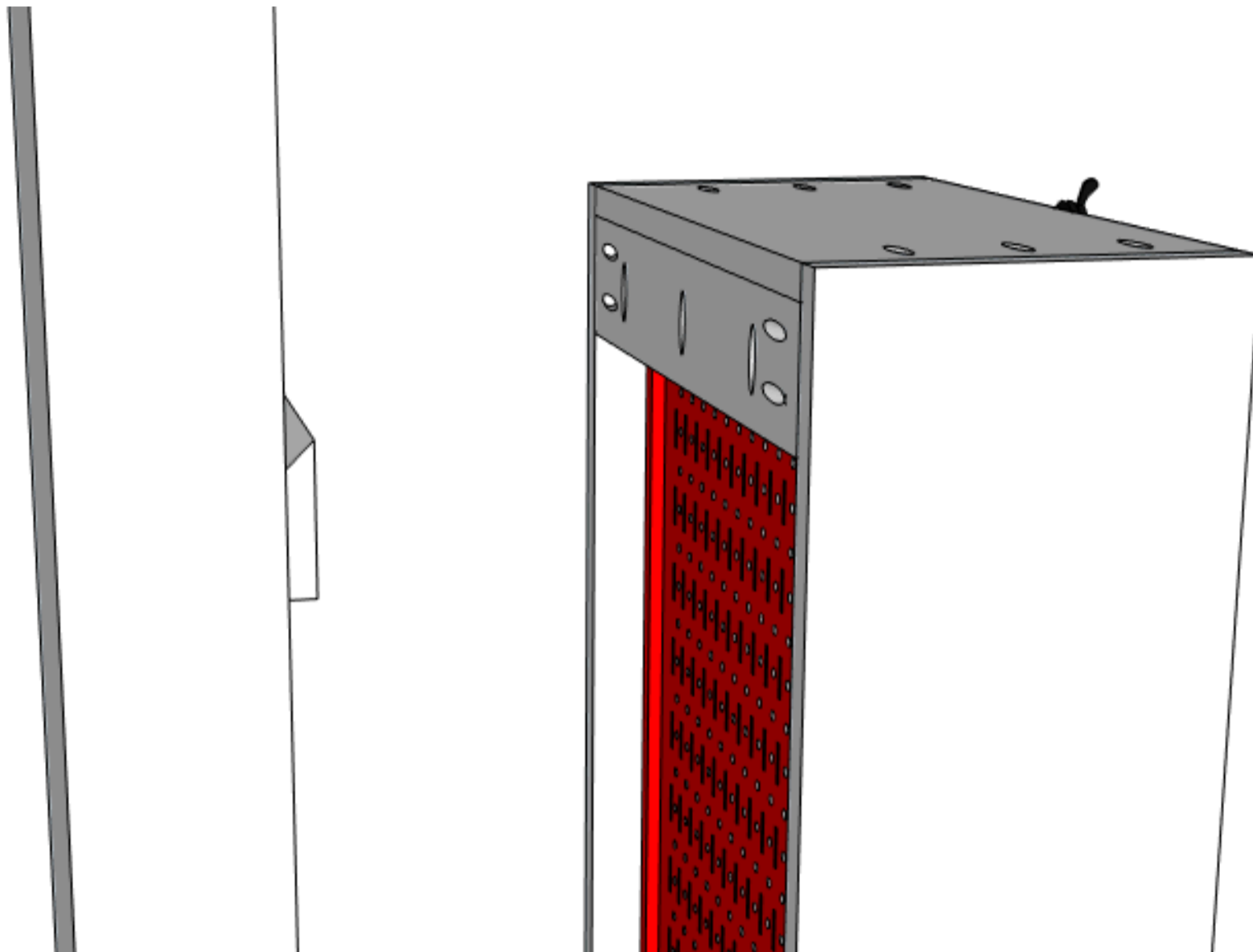

14

### Slide in the Cabinet

Lift the cabinet onto the wall cleat. The Cabinet should easily drop into place and will be securely held up.

15

### Ready to Grill!

You are now ready to enjoy your patio space with awesome grill tool storage! Just fold it open and its ready to go!

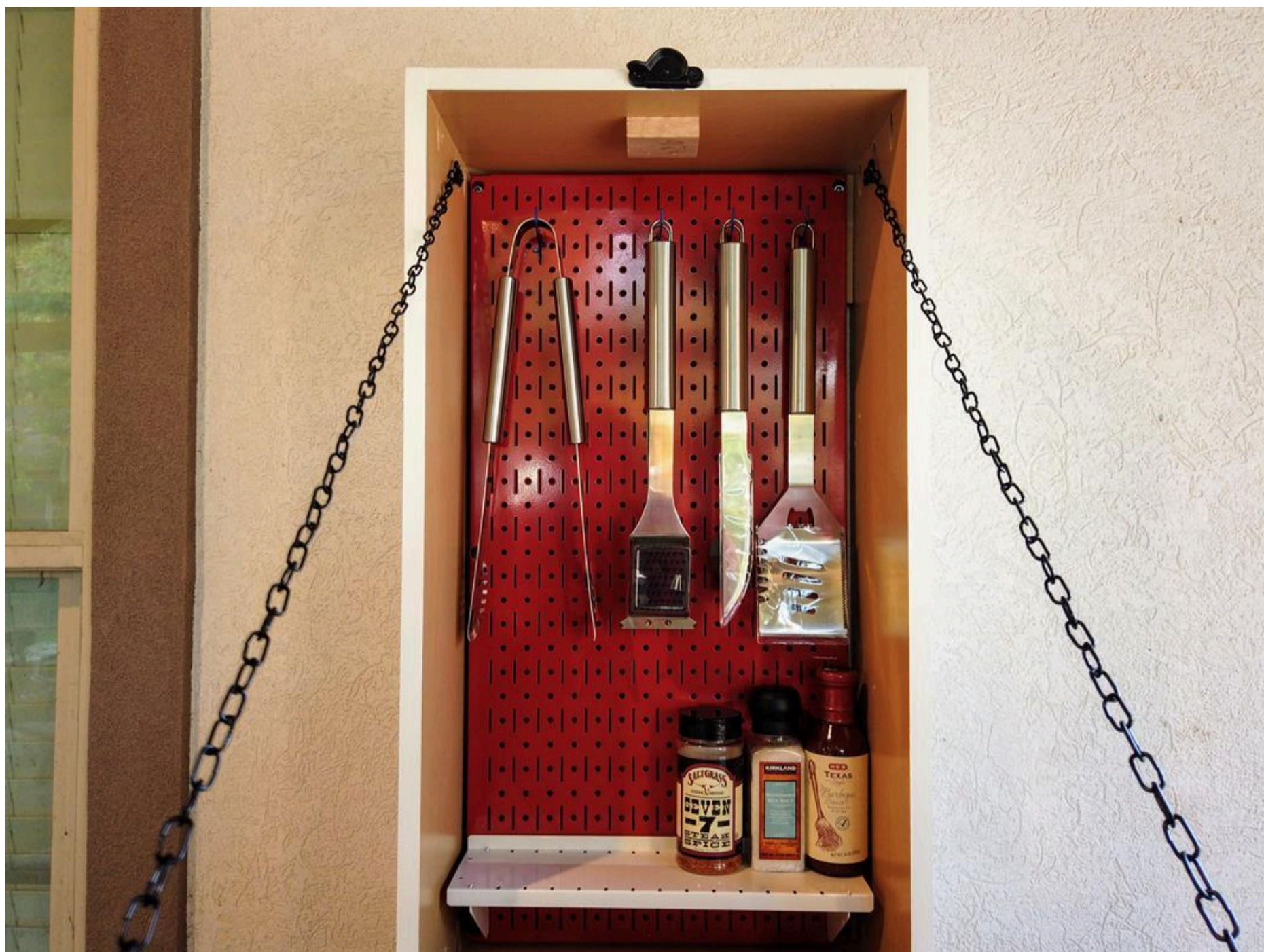

**16**

**Attach Small frame to Table top**

After the Big frame and Table Top dry, attach the Small Frame to the top using wood glue and brad nails. Check to make sure you have about 1/8" spacing all the way around for a nice reveal.

---

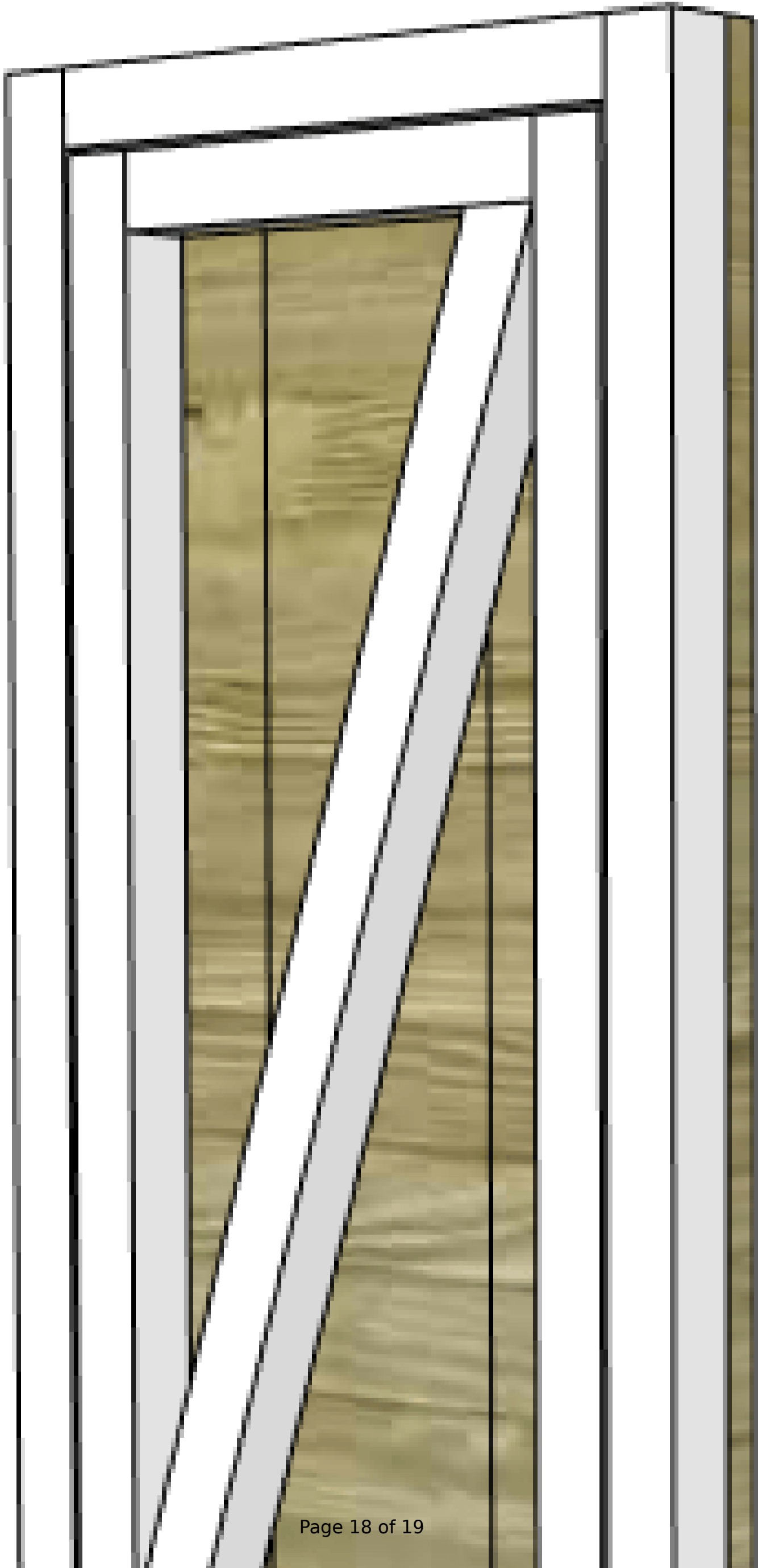

17

### Add Sash lock

Add the Sash lock to the top of the cabinet to keep it closed when not in use.

